

Adjustable DC-DC Buck Regulator – AP3429/A

Input Range: 3.9V to 5.5V
 Output Voltage: 3.3V
 Output Current: 2A MAX

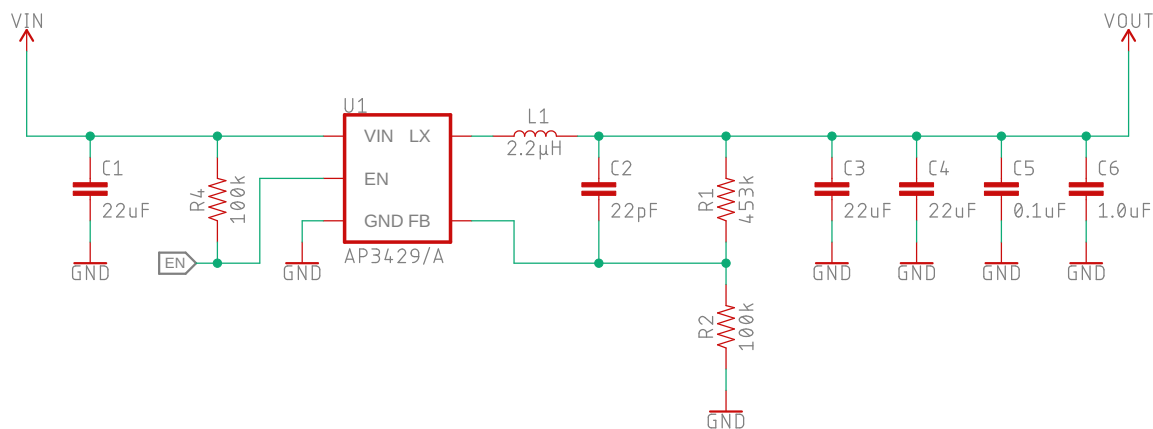

Power Output Indicator



Power LED

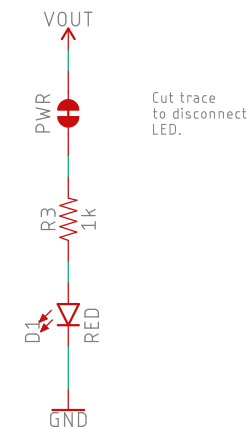

Connectors

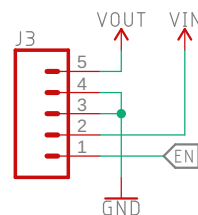
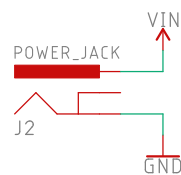
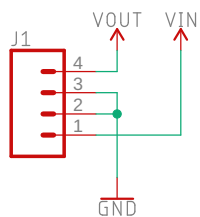

WARNING: Only connect one Vin input at a time



Released under the Creative Commons
 Attribution Share-Alike 4.0 License
<https://creativecommons.org/licenses/by-sa/4.0/>



TITLE: Buck_Regulator_AP3429A_3V3

Design by: M. Chodikov

REV:
v11

Date: 3/13/2023 12:47 PM

Sheet: 1/1