

LADYADA R IS FOR ROBOTS

is a coloring book adventure with robots, their inventors and more.

Makers of all ages can learn, color and share their favorite robots and roboticists.

Art & Design: Bruce Yan Content: Ladyada & PT Layout: David Stadler



R LADYADA COLORING BOOK IS FOR ROBOTS

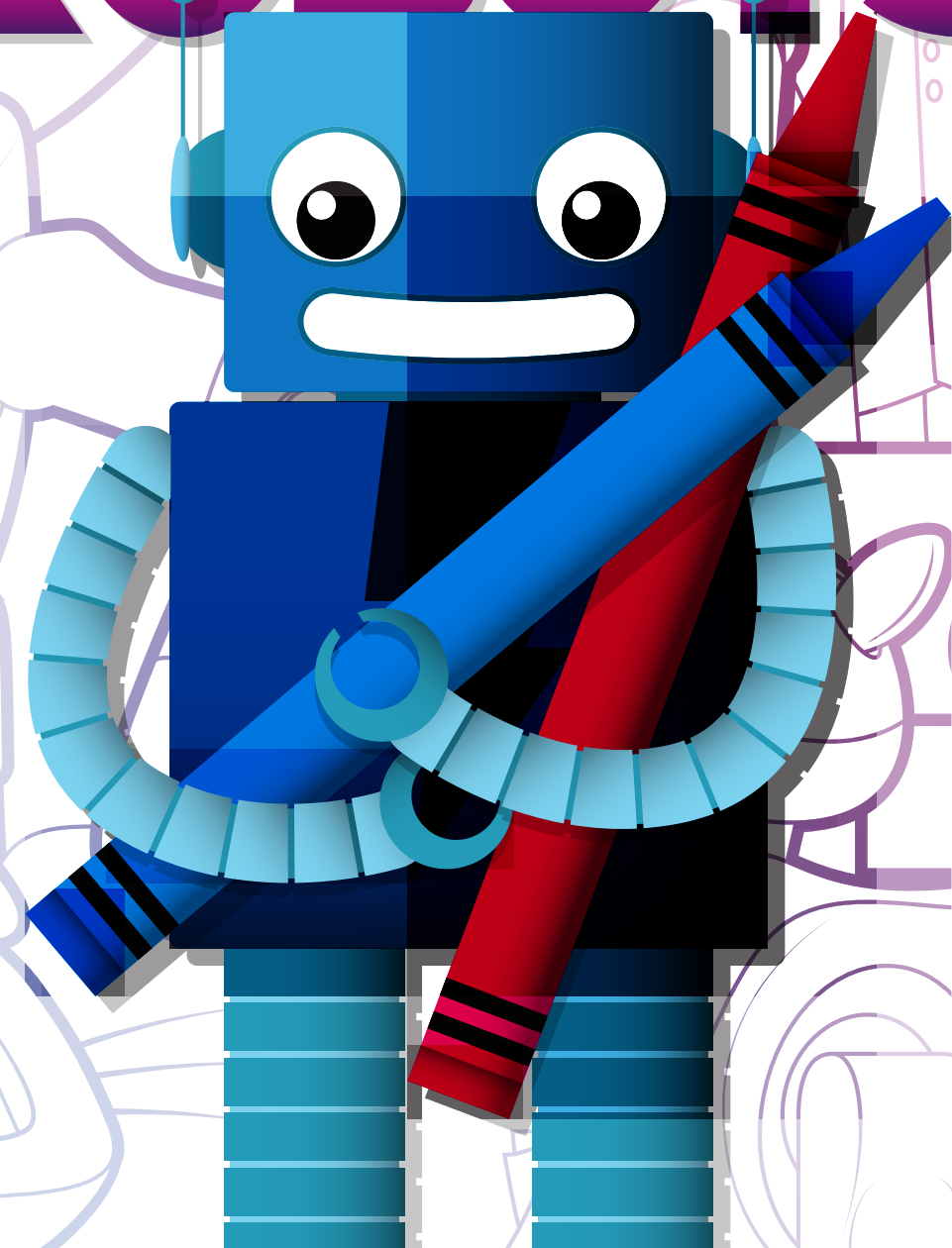

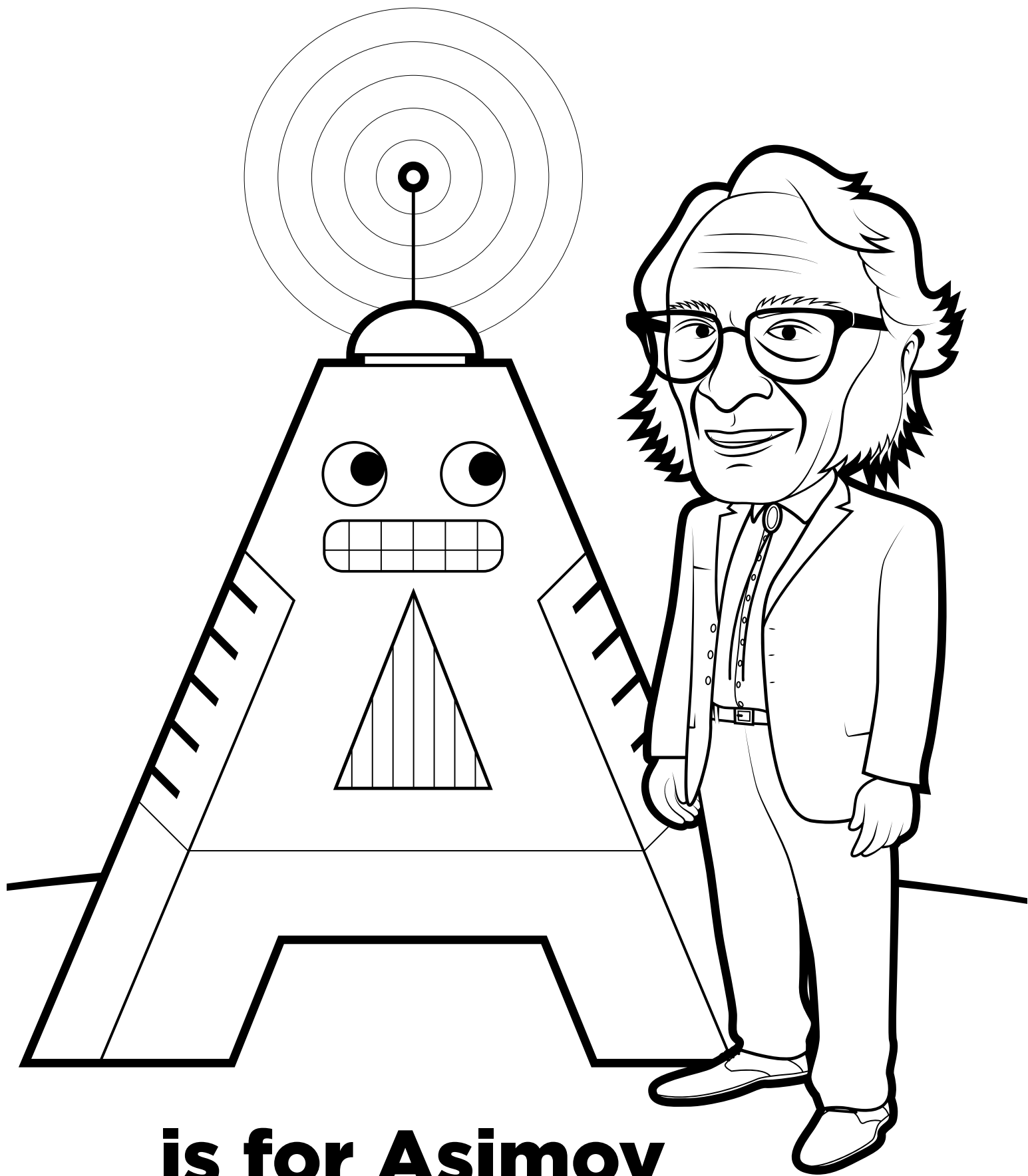

is for Asimov

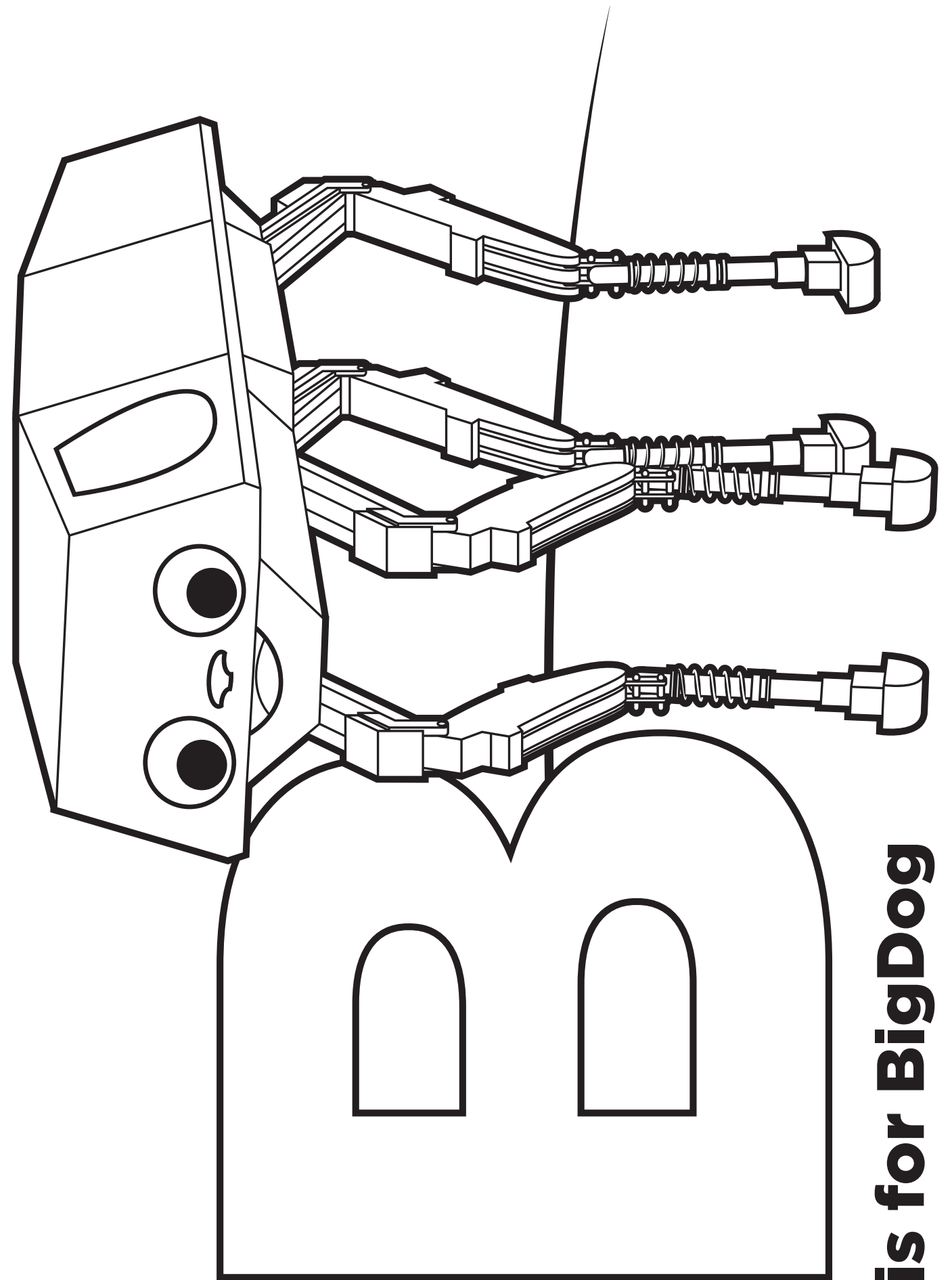

is for BigDog

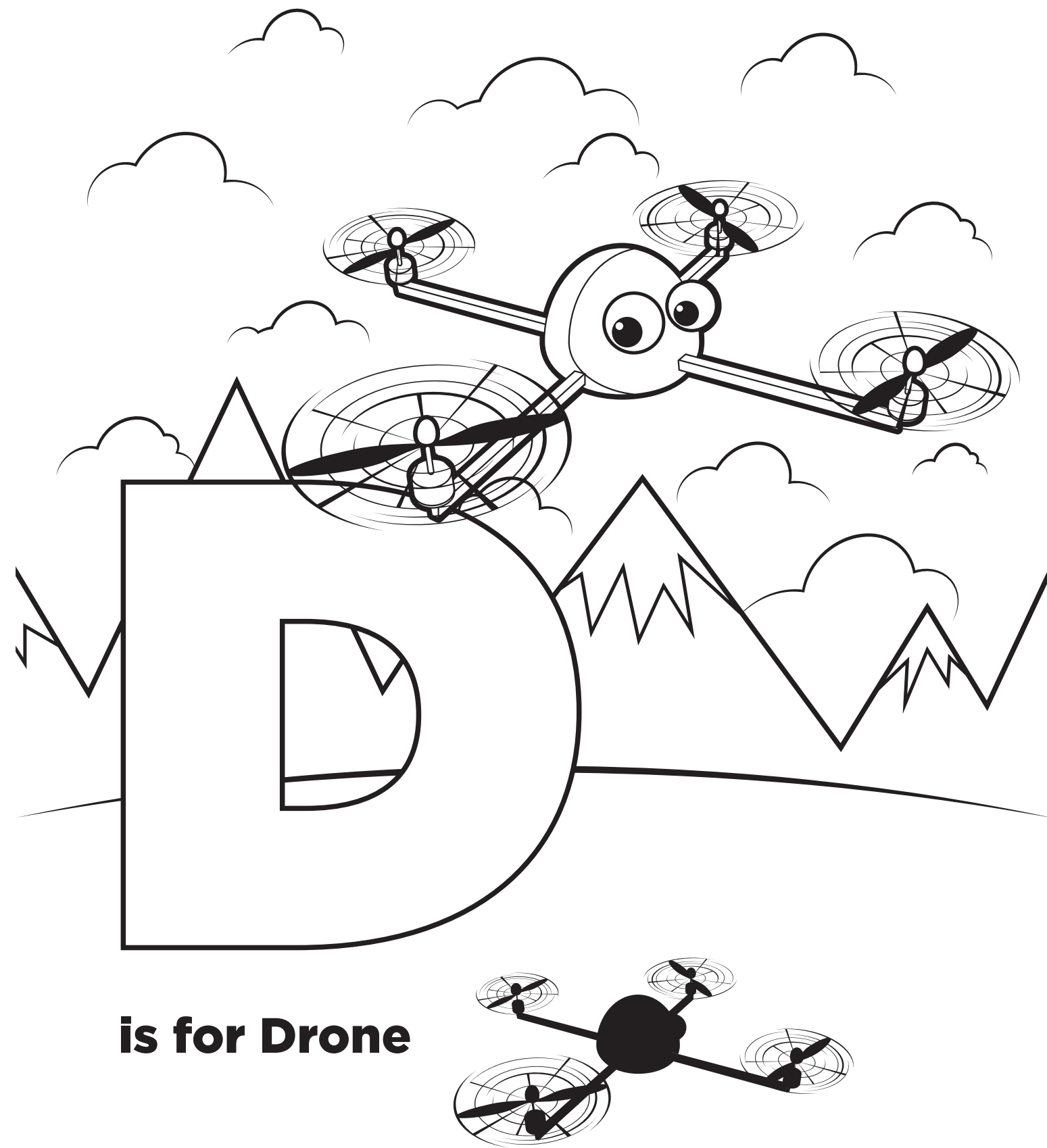
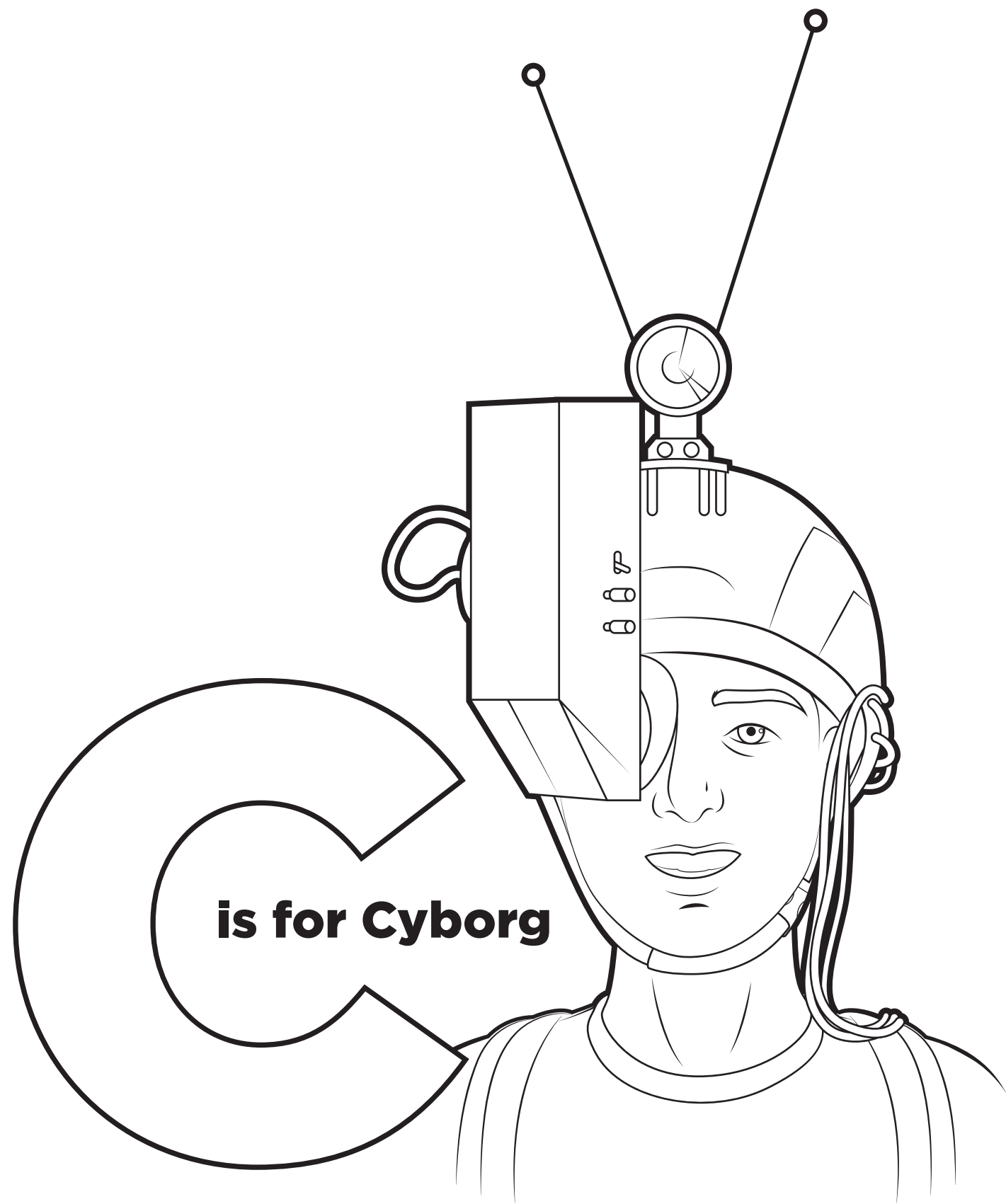

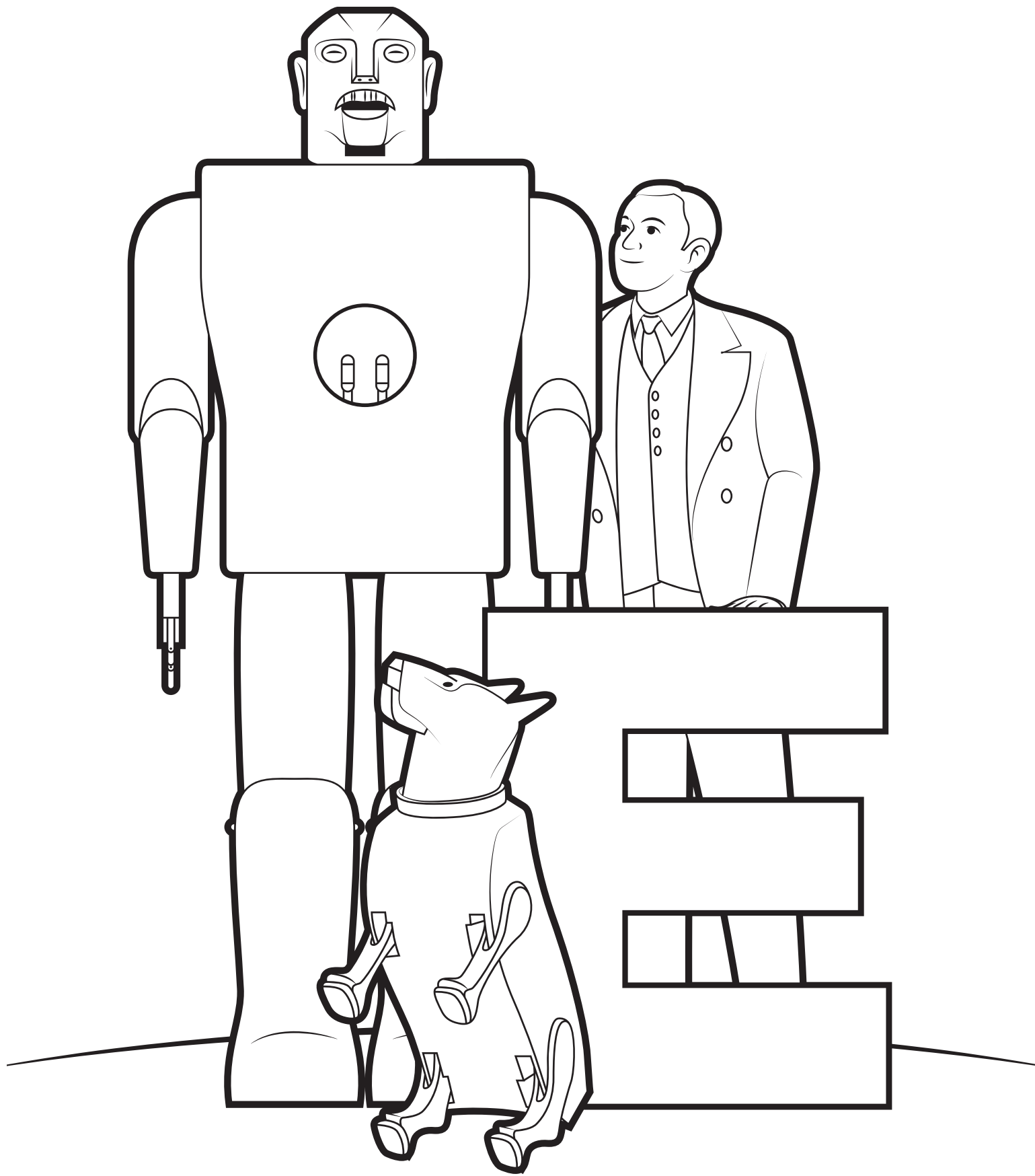

is for Elektro

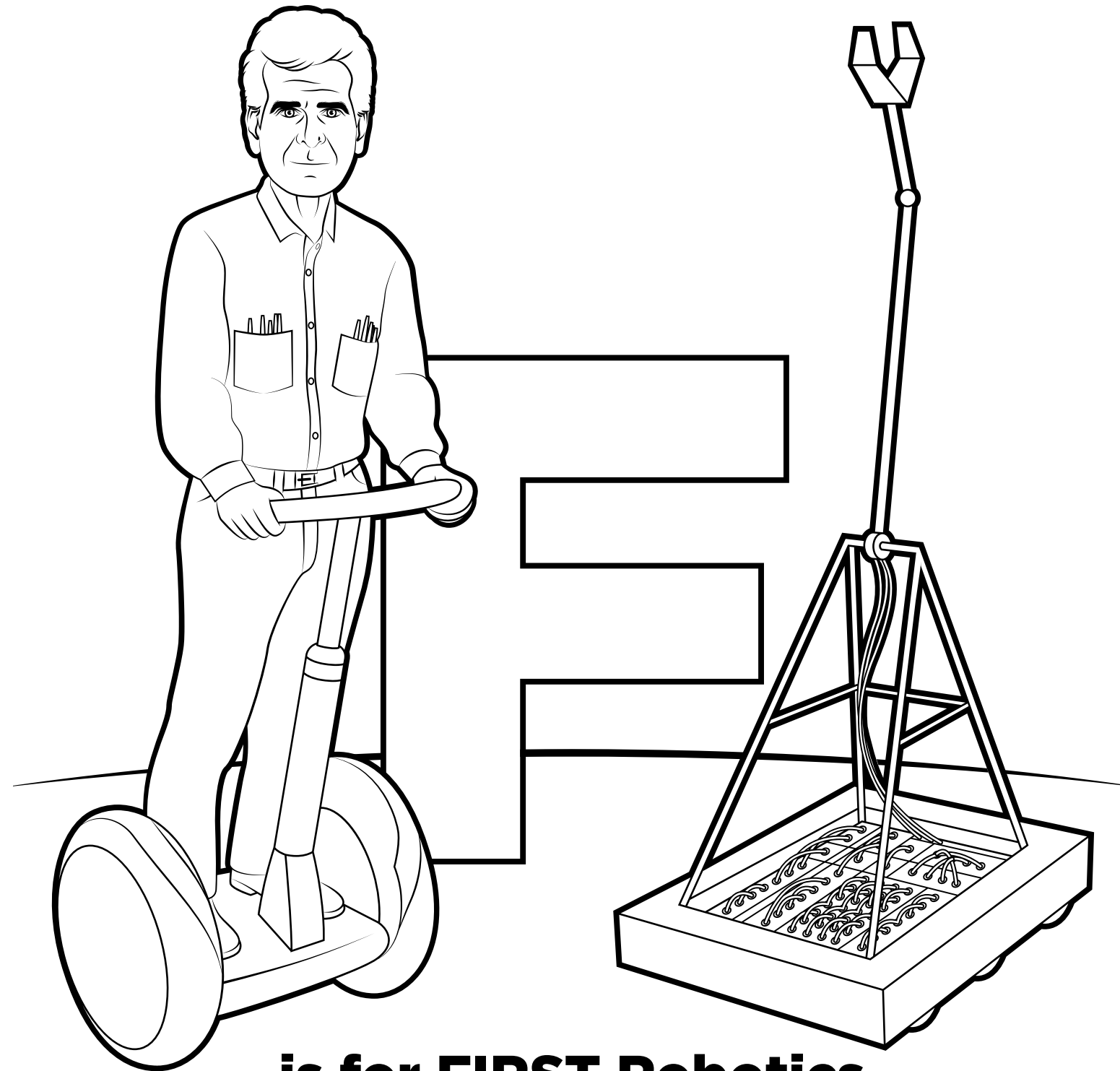

is for FIRST Robotics



is for GPS

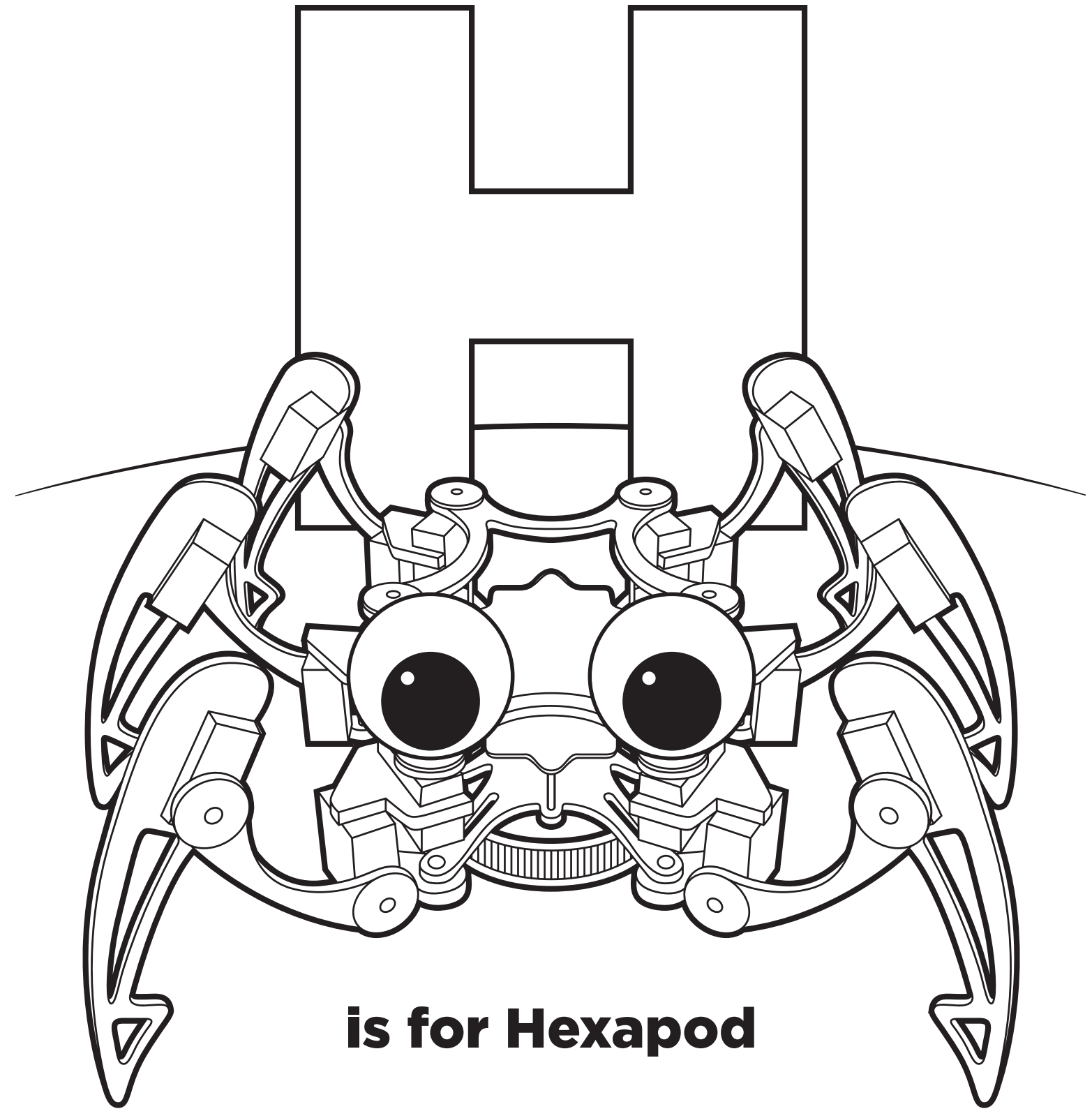

is for Hexapod

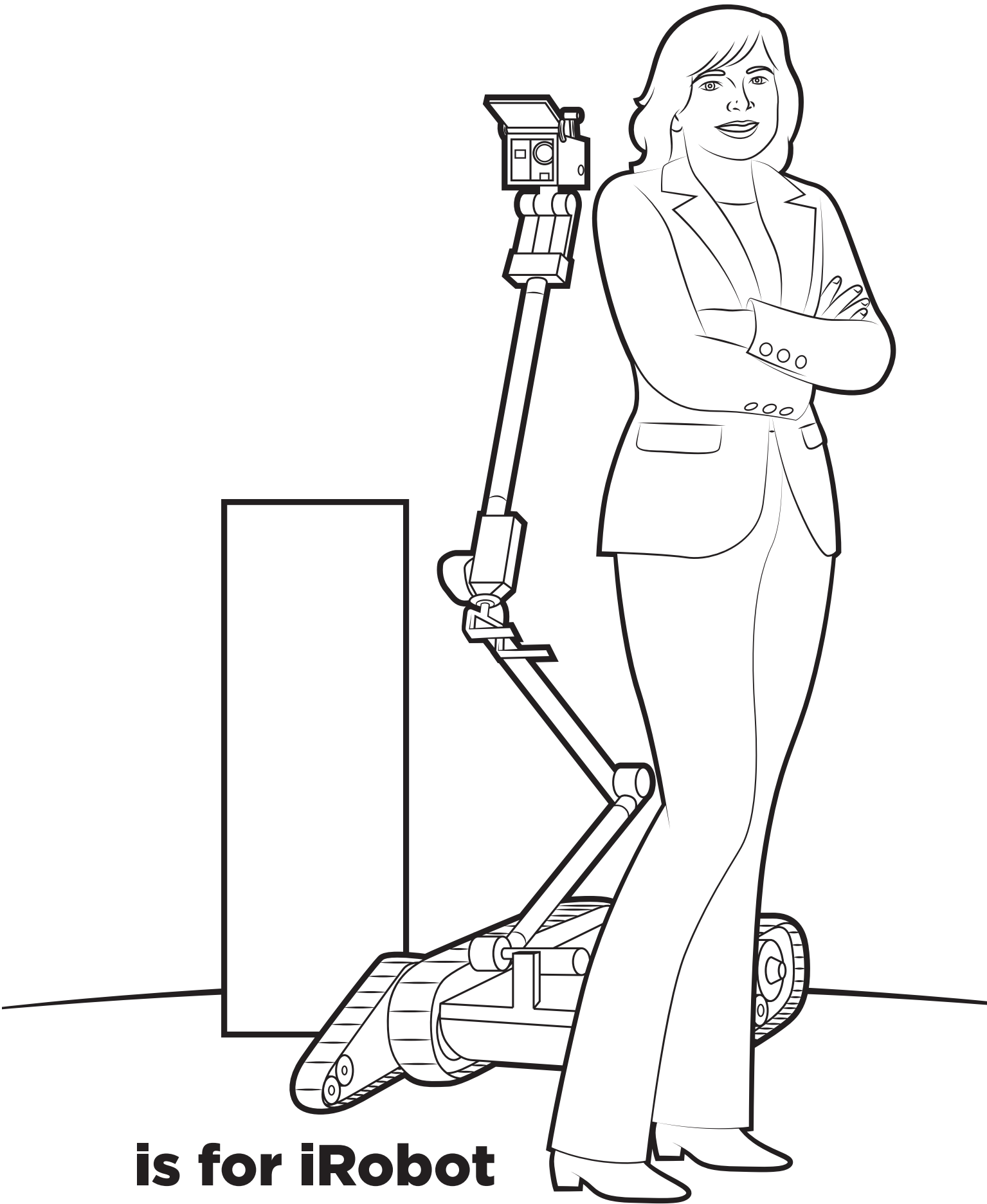

is for iRobot

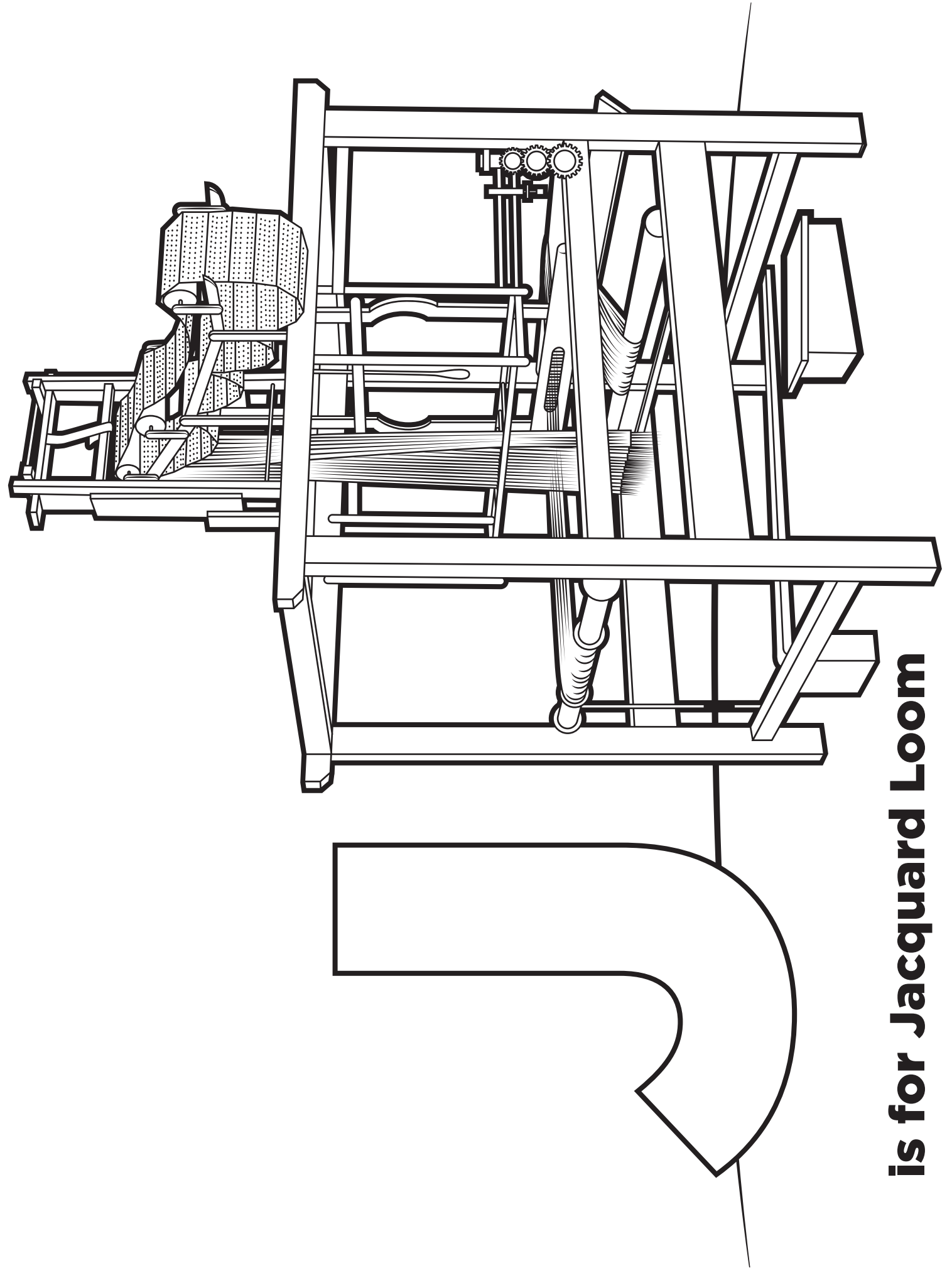

is for Jacquard Loom

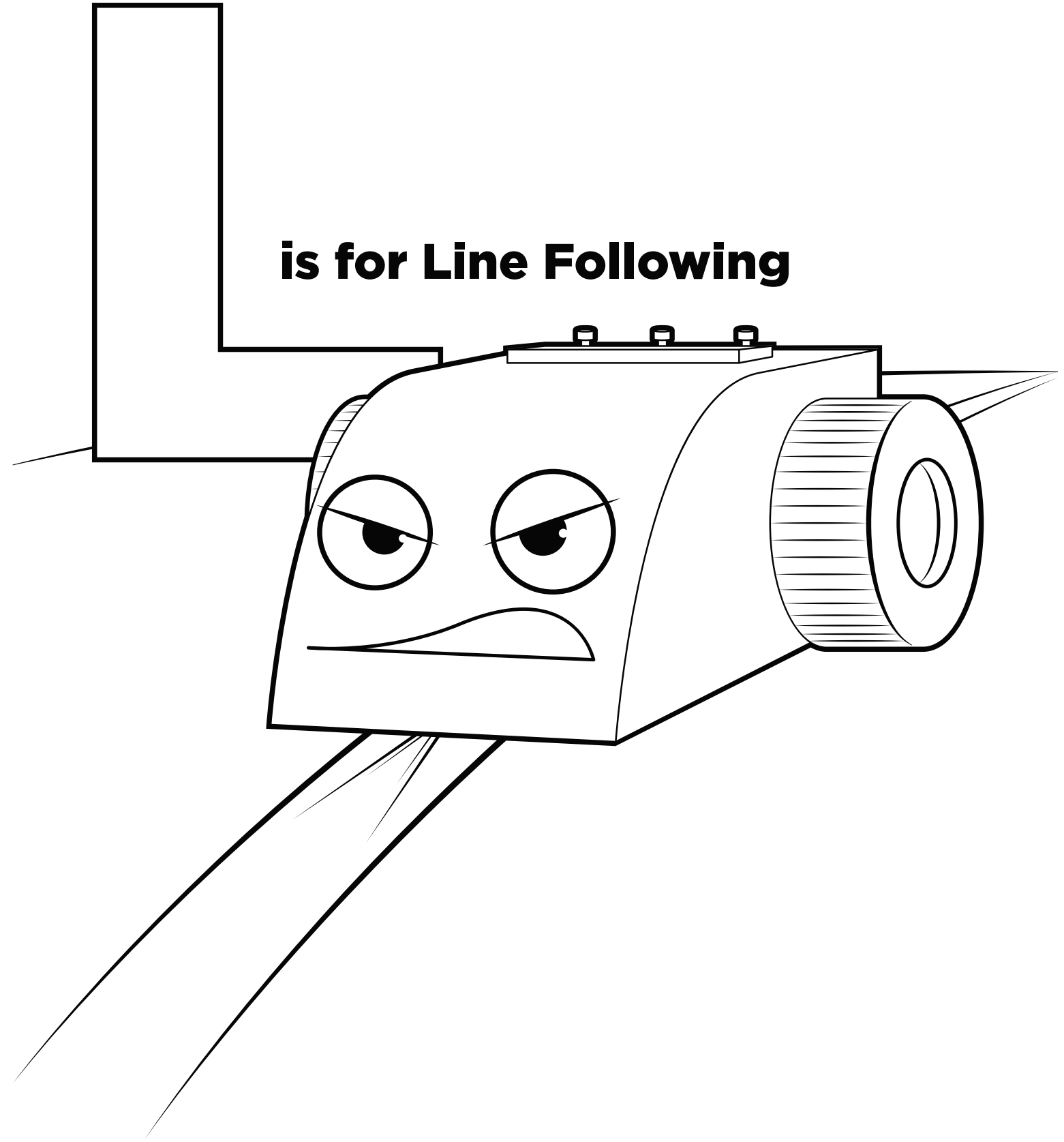
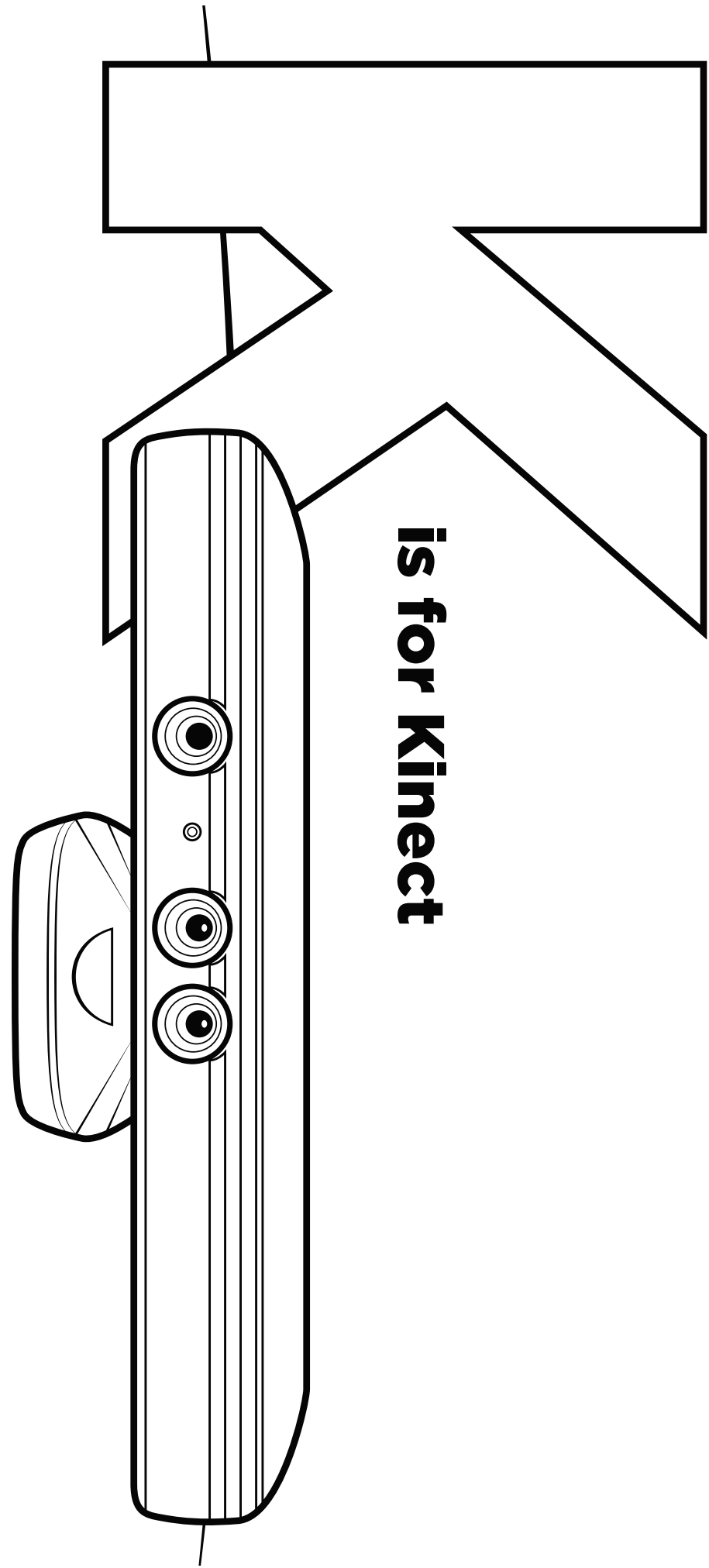

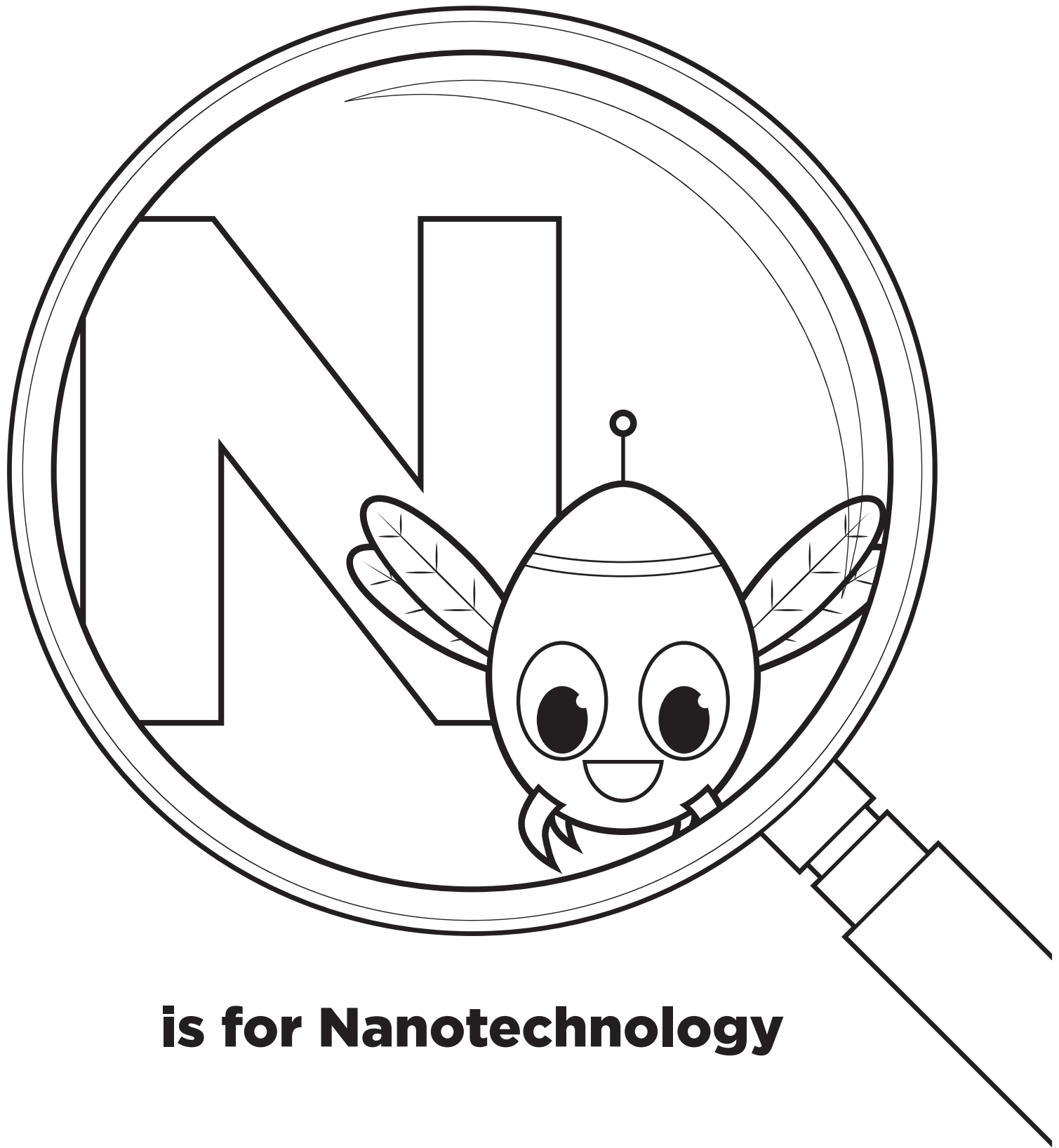

is for Nanotechnology

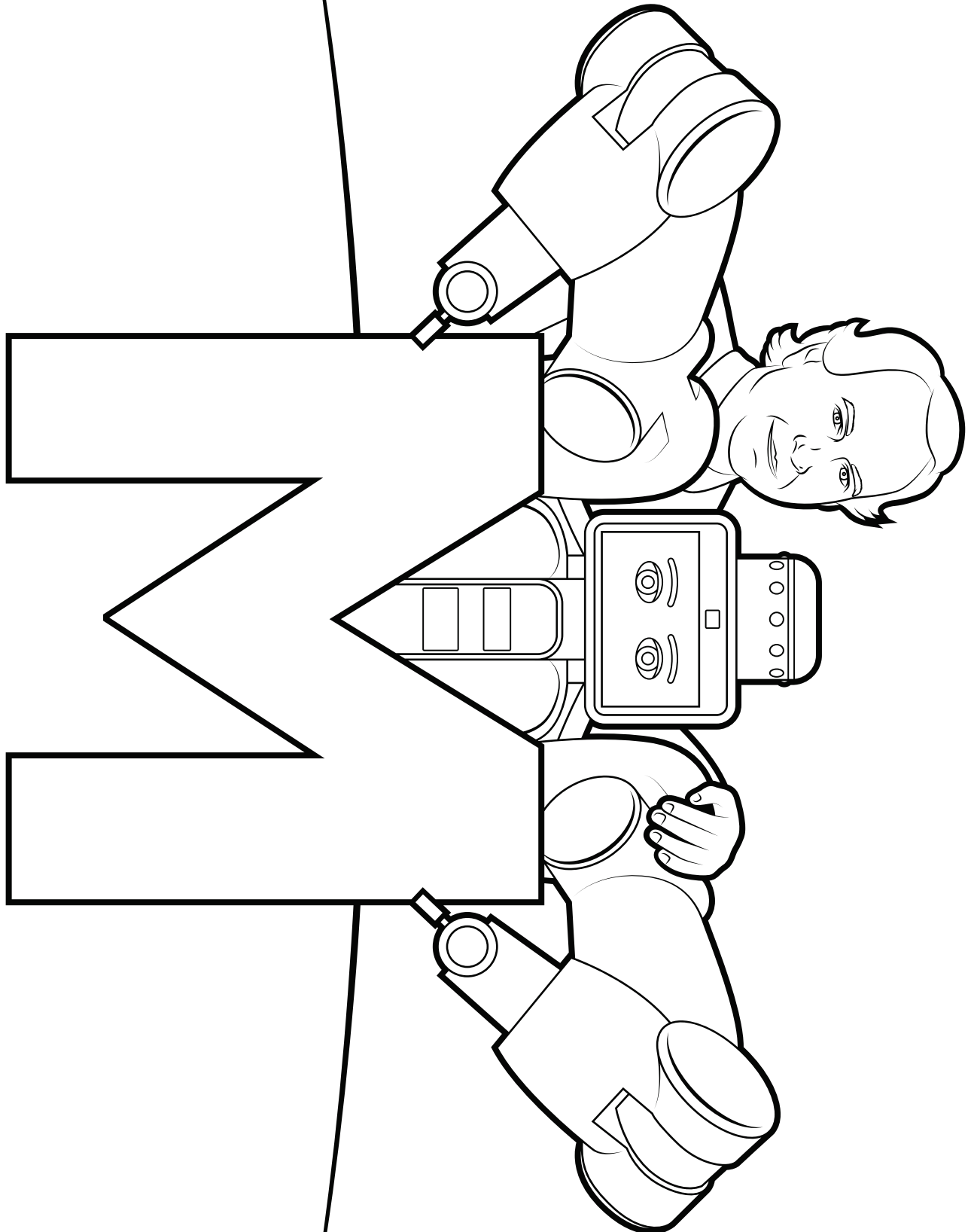

is for Manufacturing

is for Obstacle Avoidance

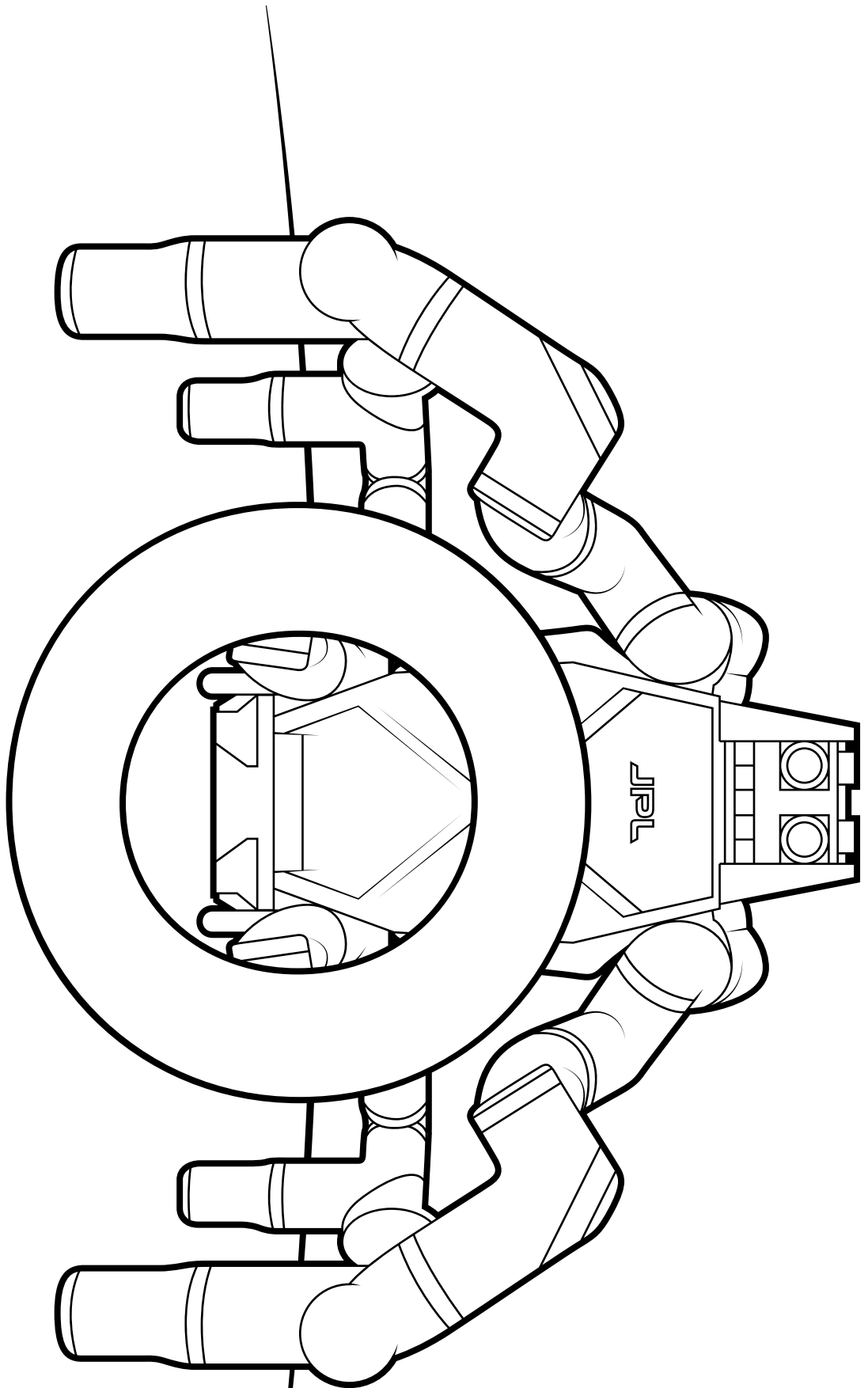

is for Prosthetic

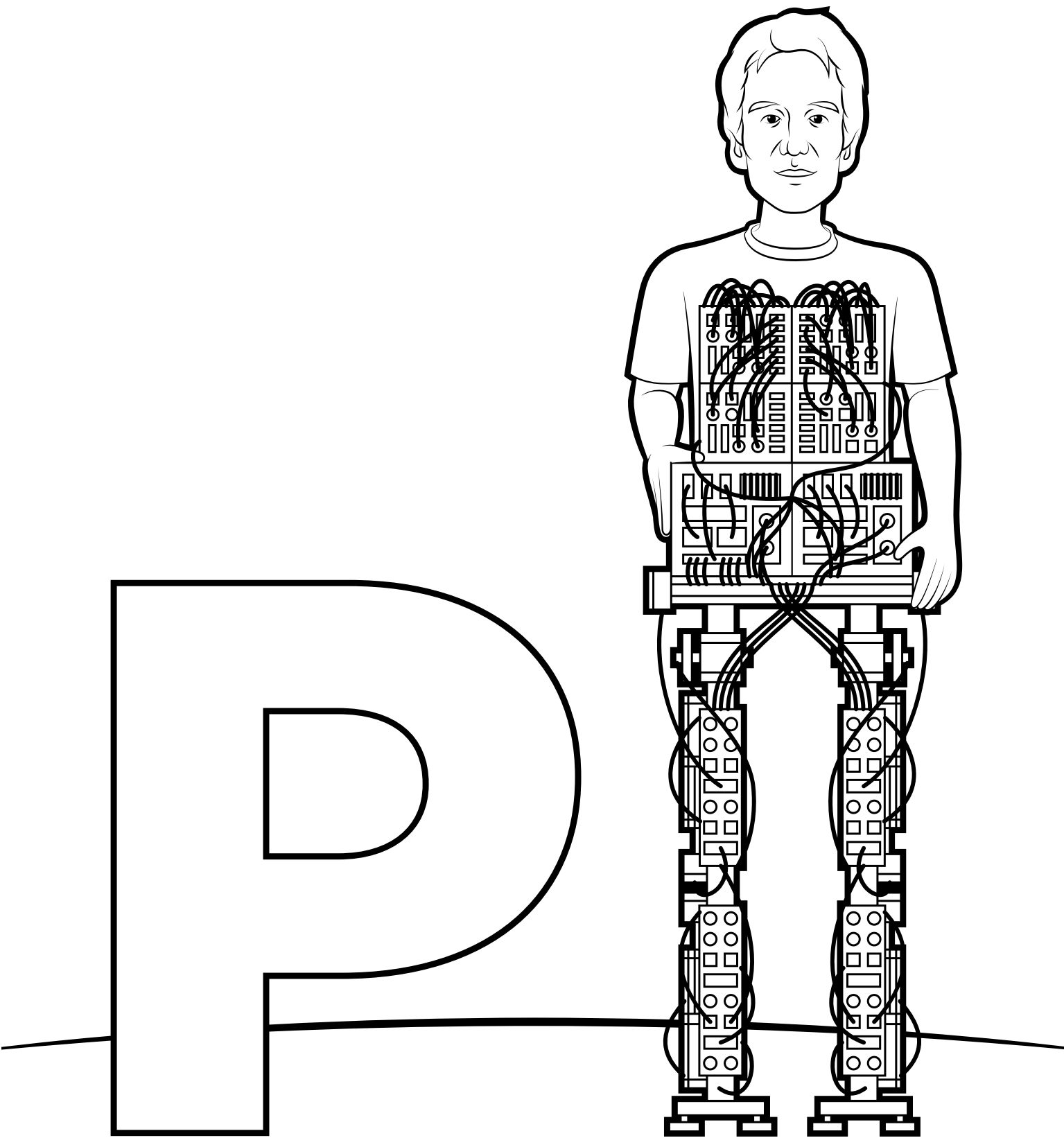

is for QRIO

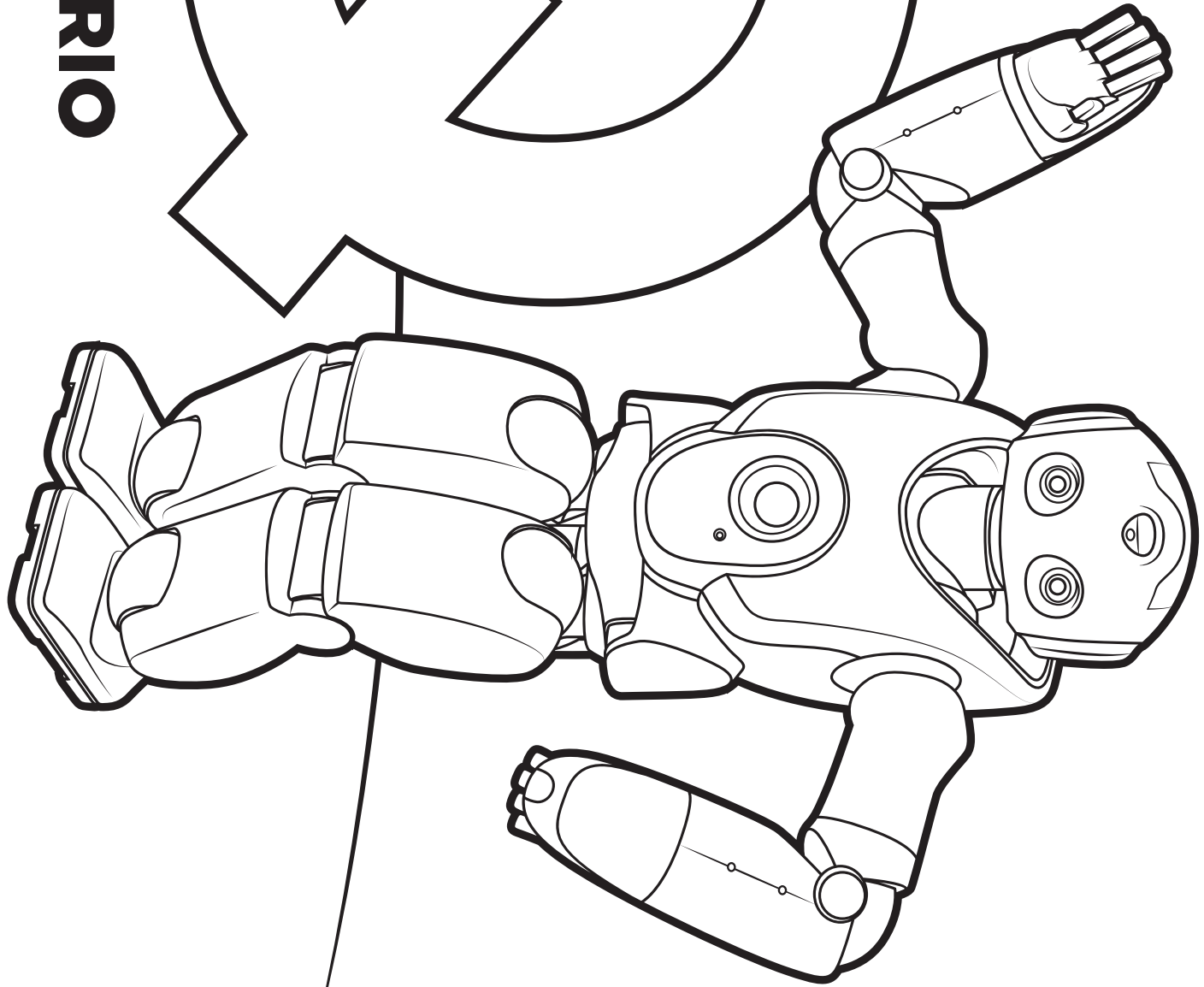
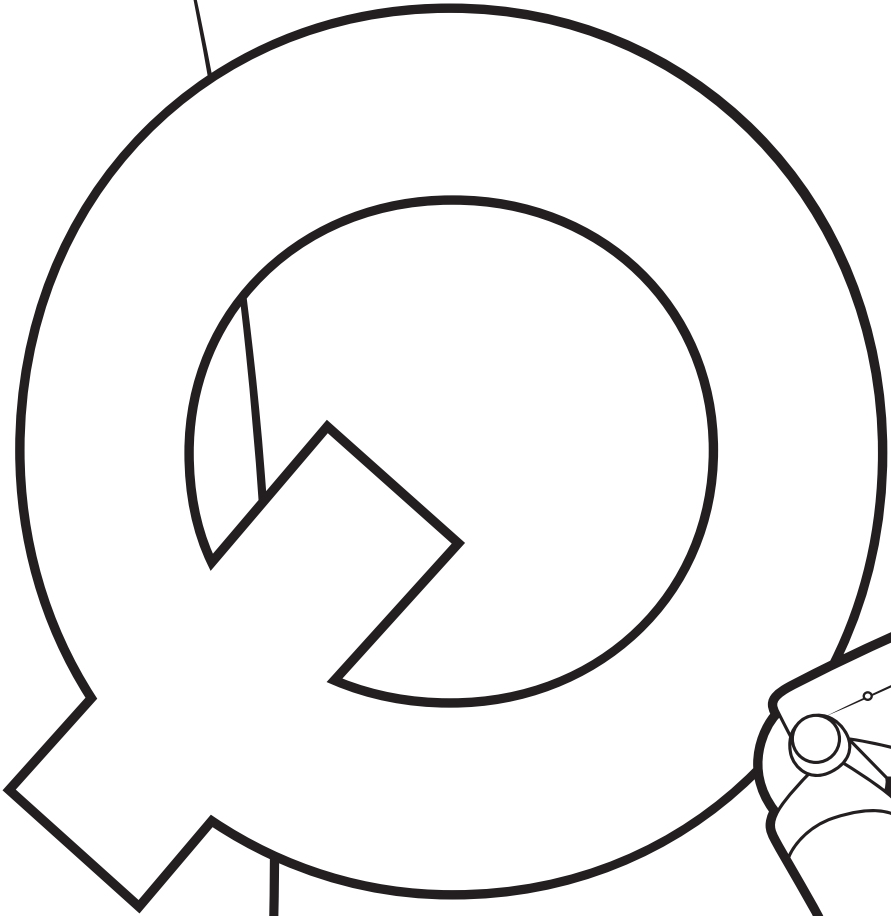

is for Roomba

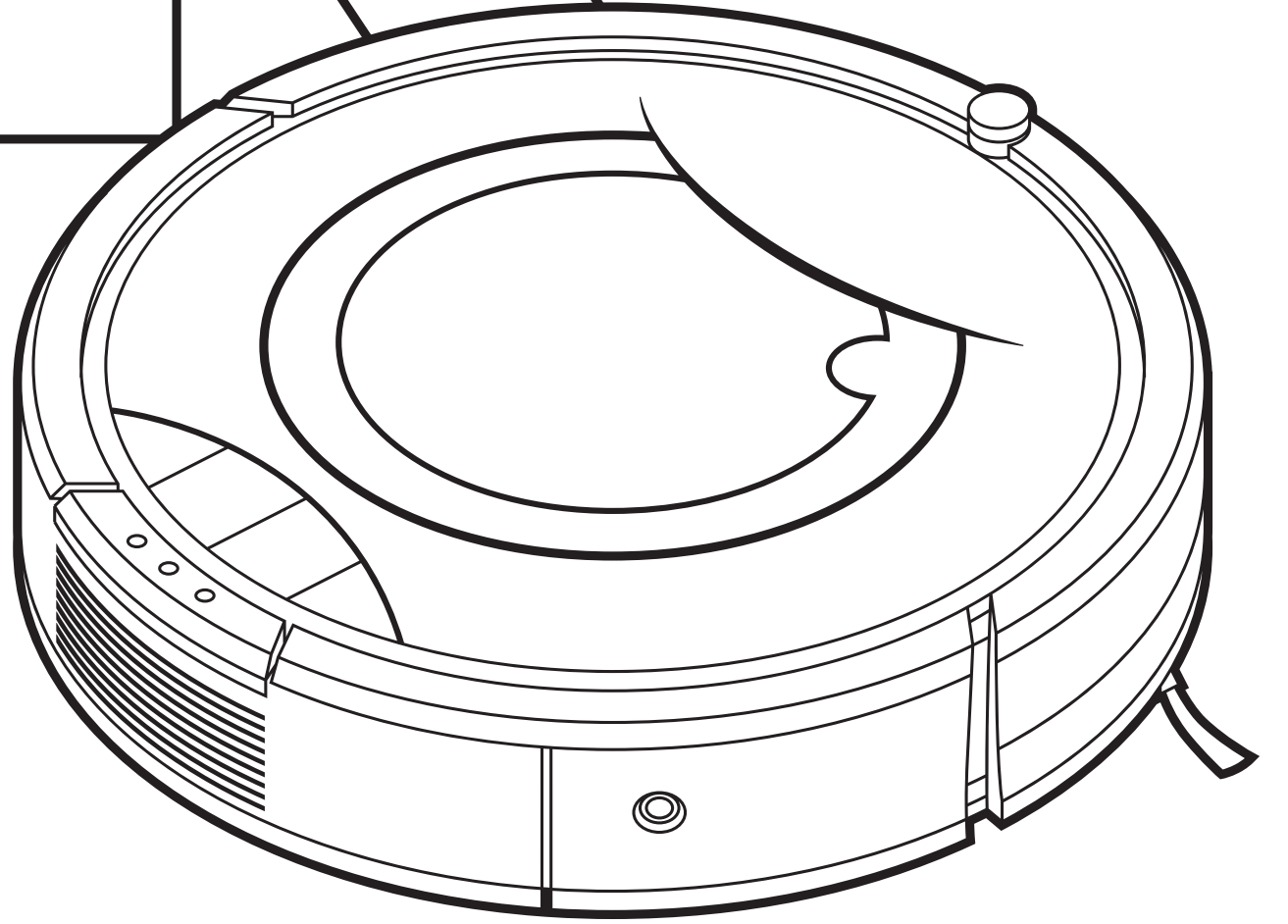

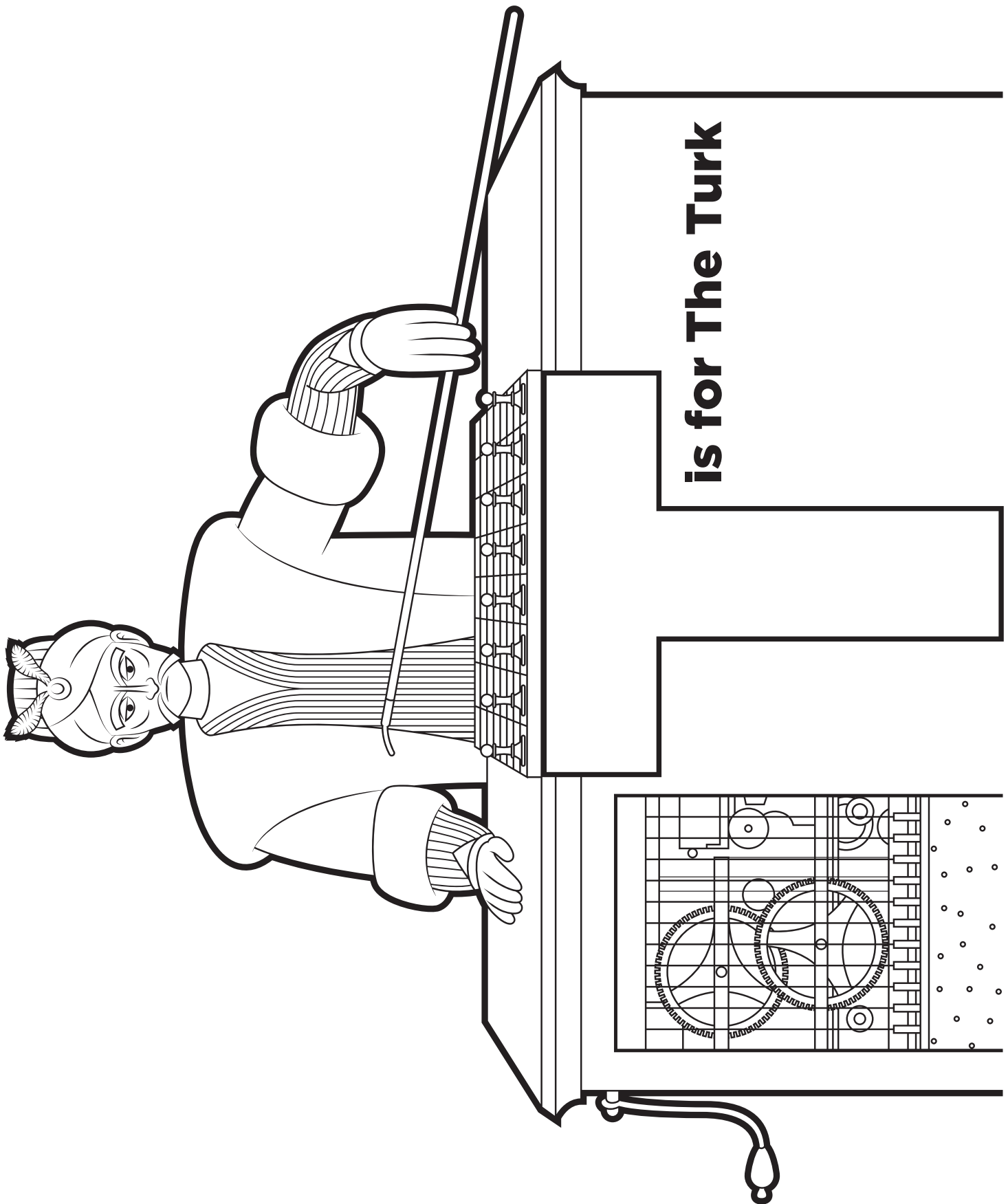
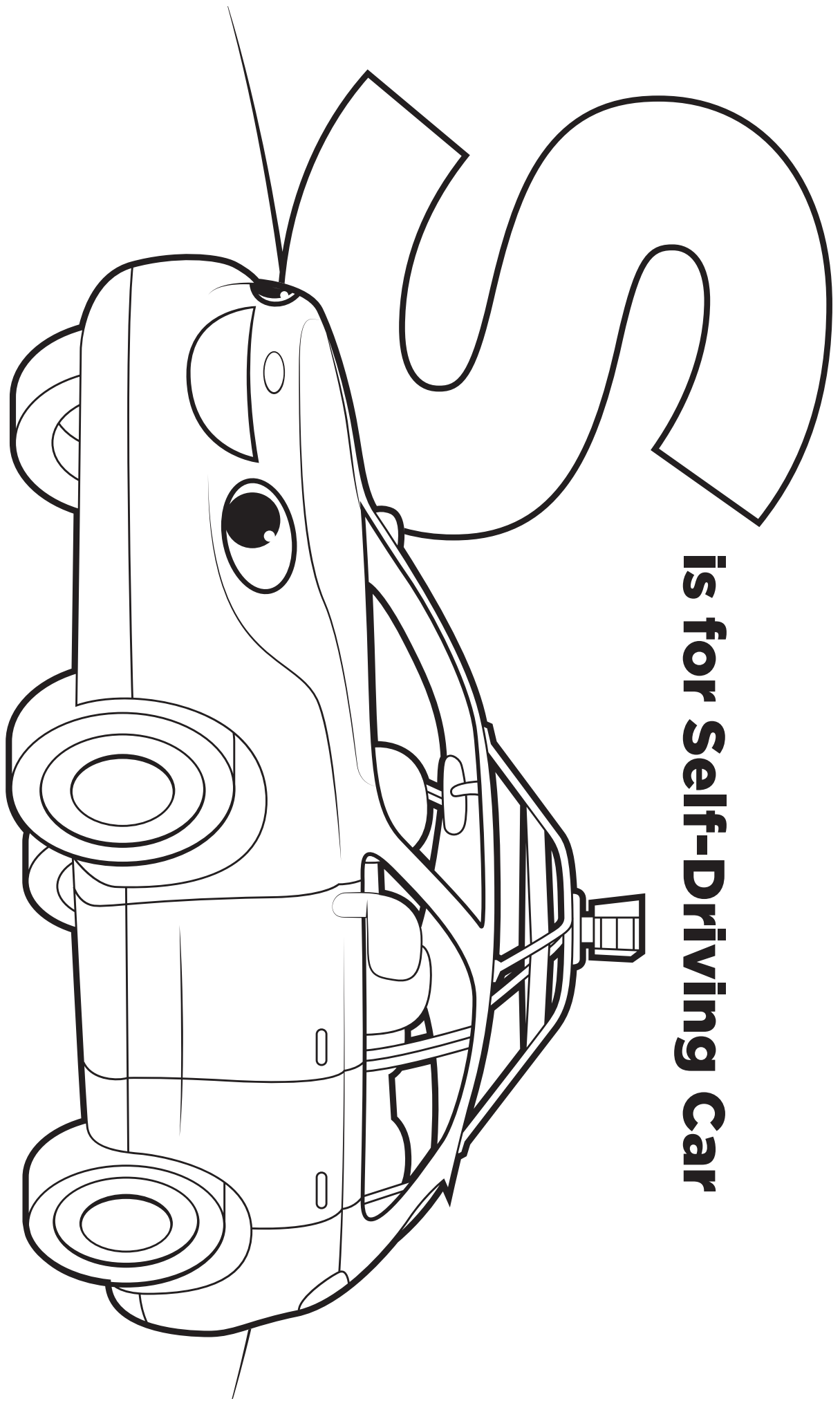

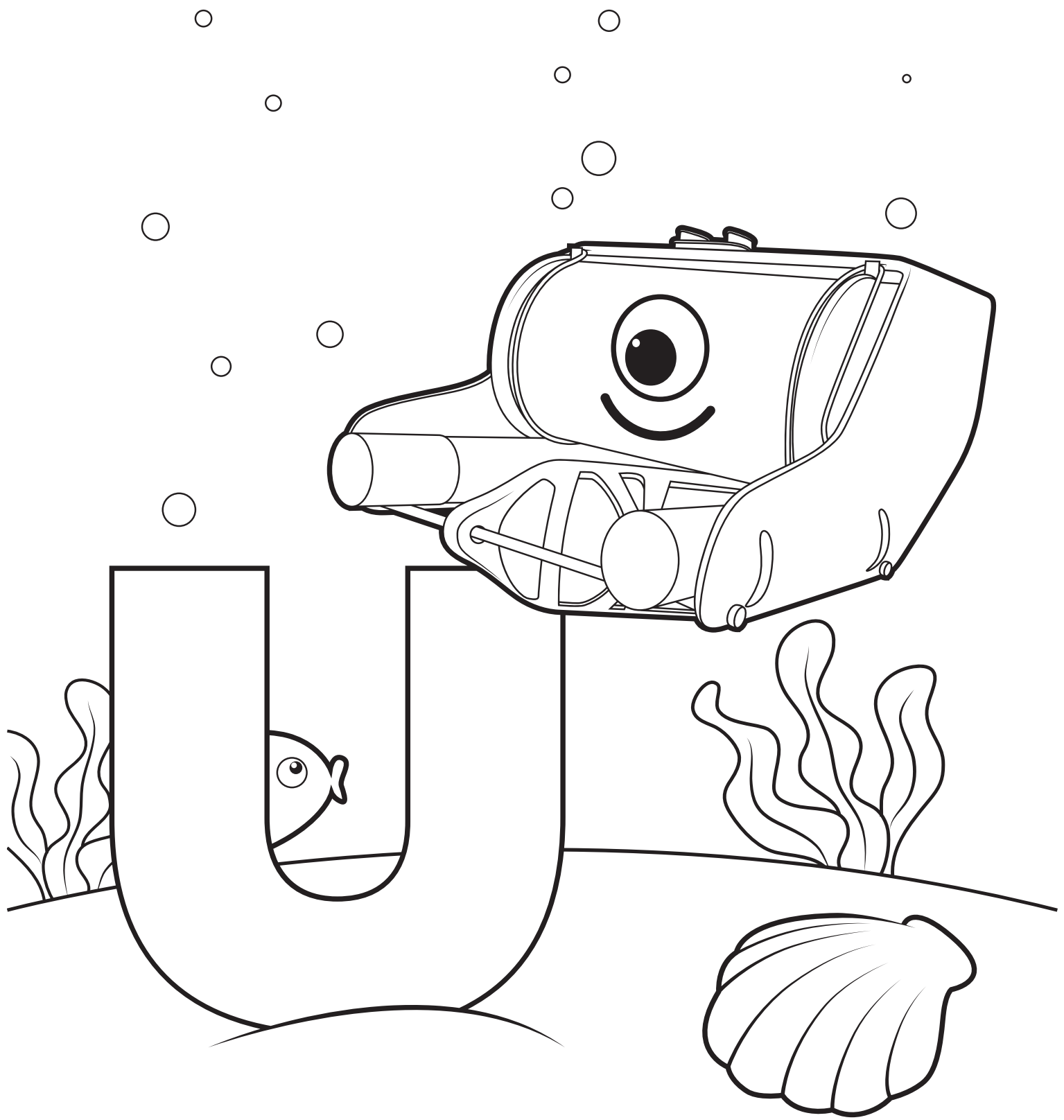

is for Underwater Open-Source Robot

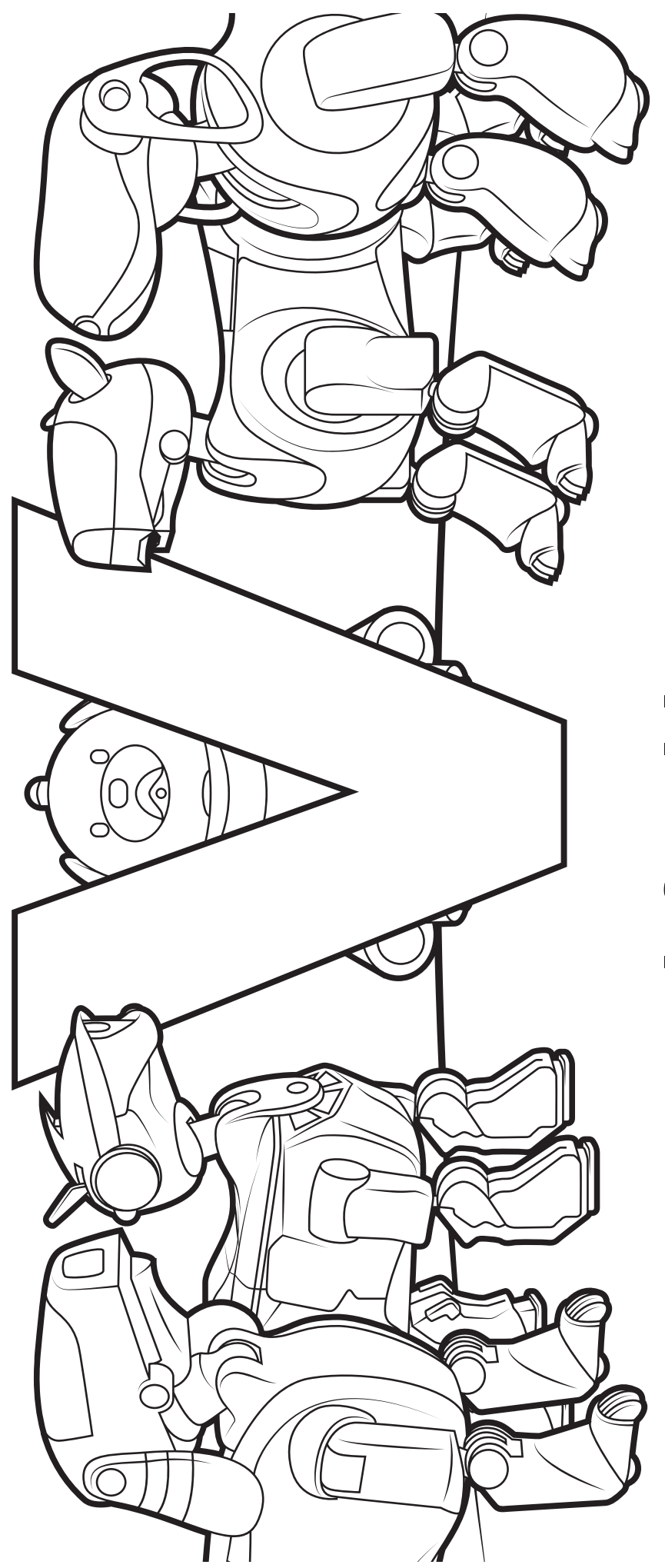
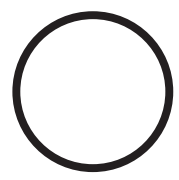

is for Vision

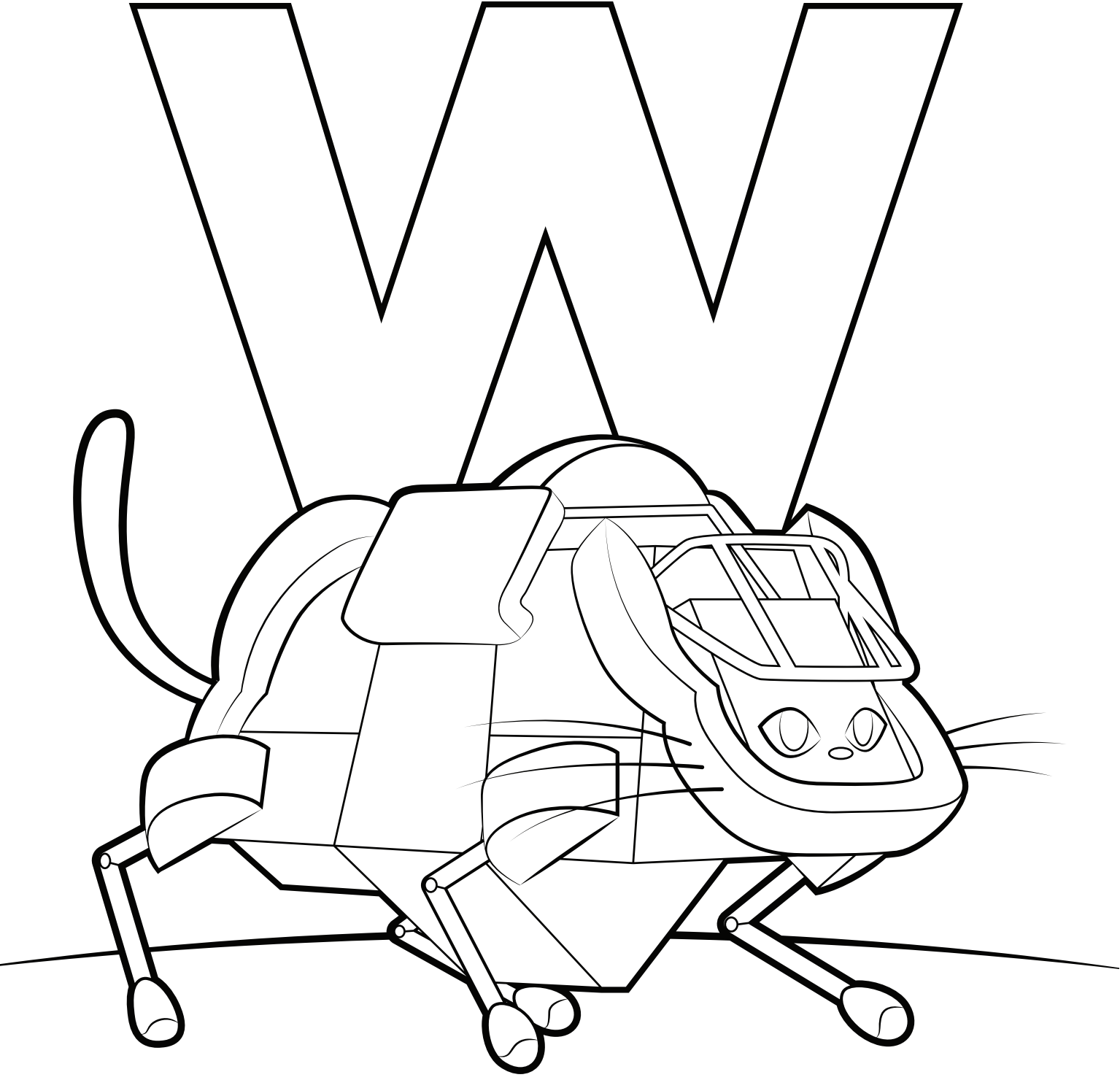

is for WildCat

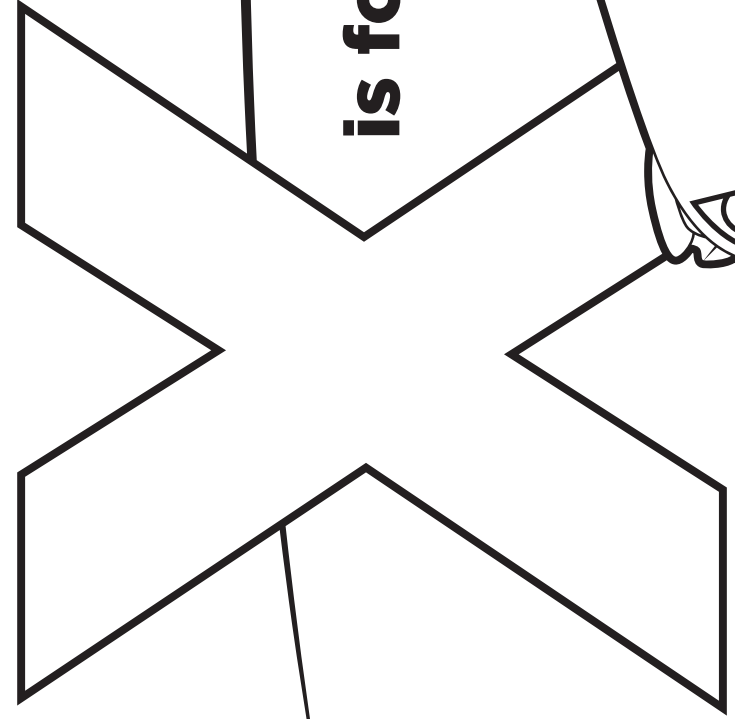

is for X-RHex

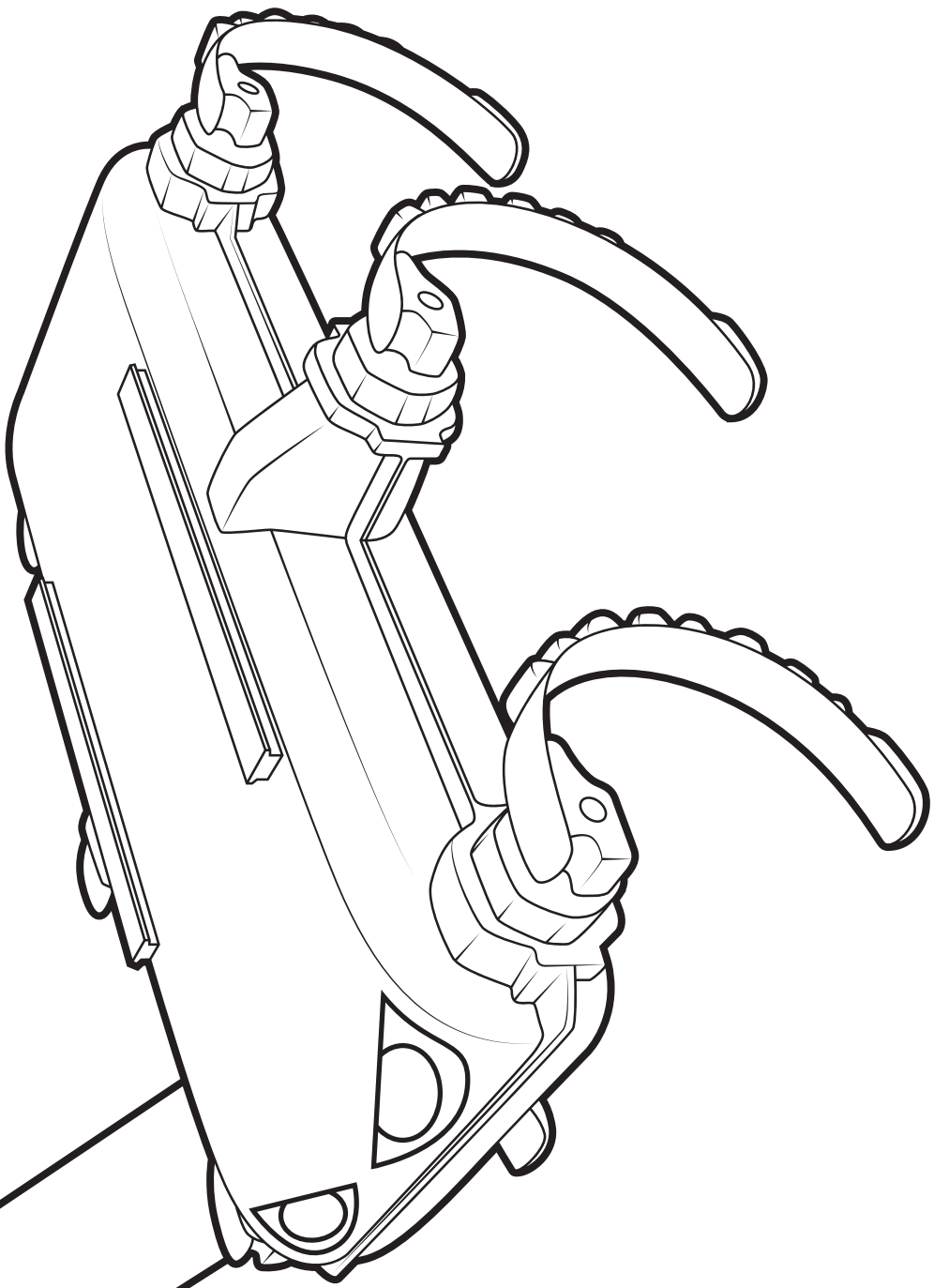

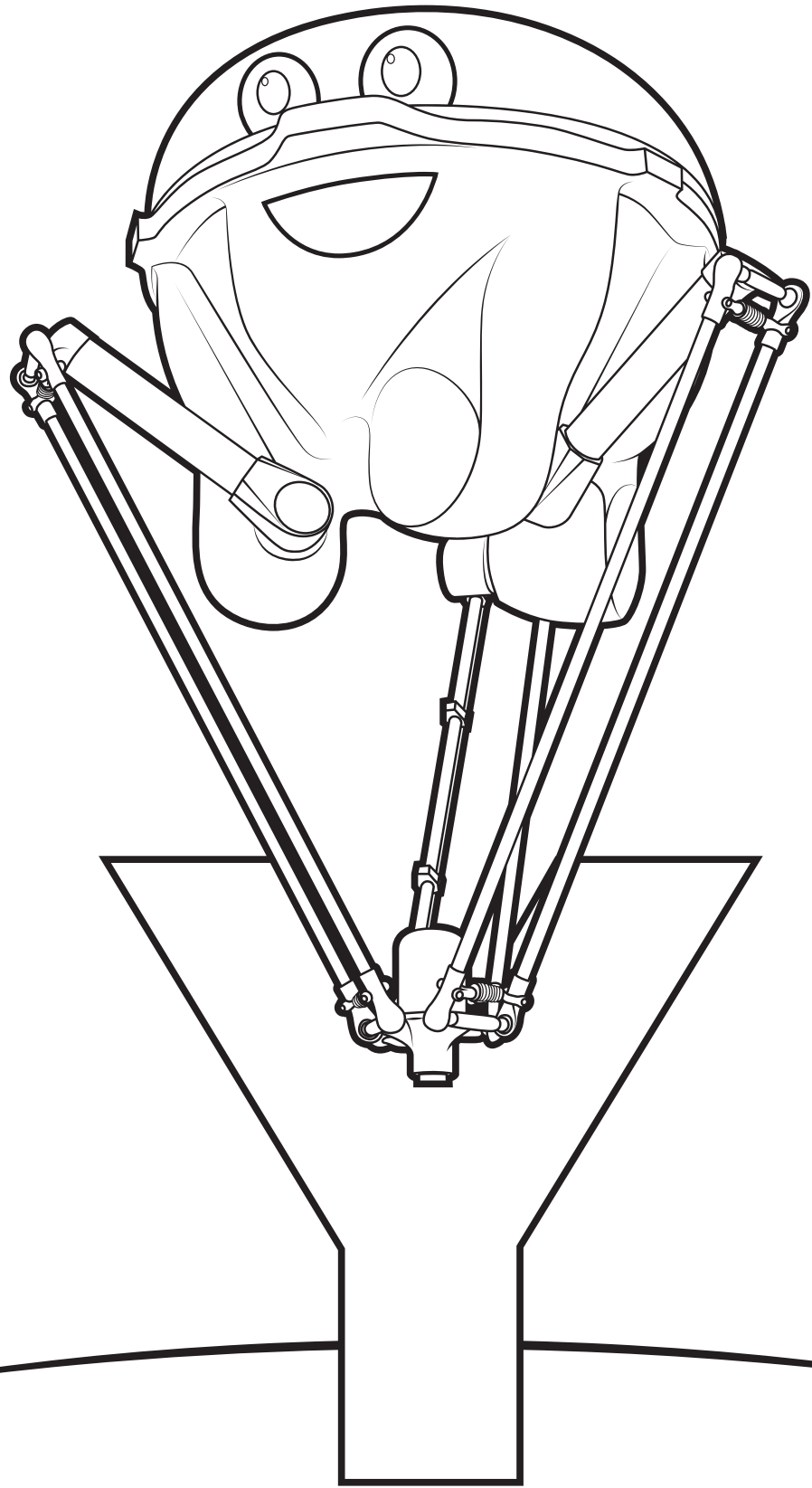

is for Y-Series (Delta)

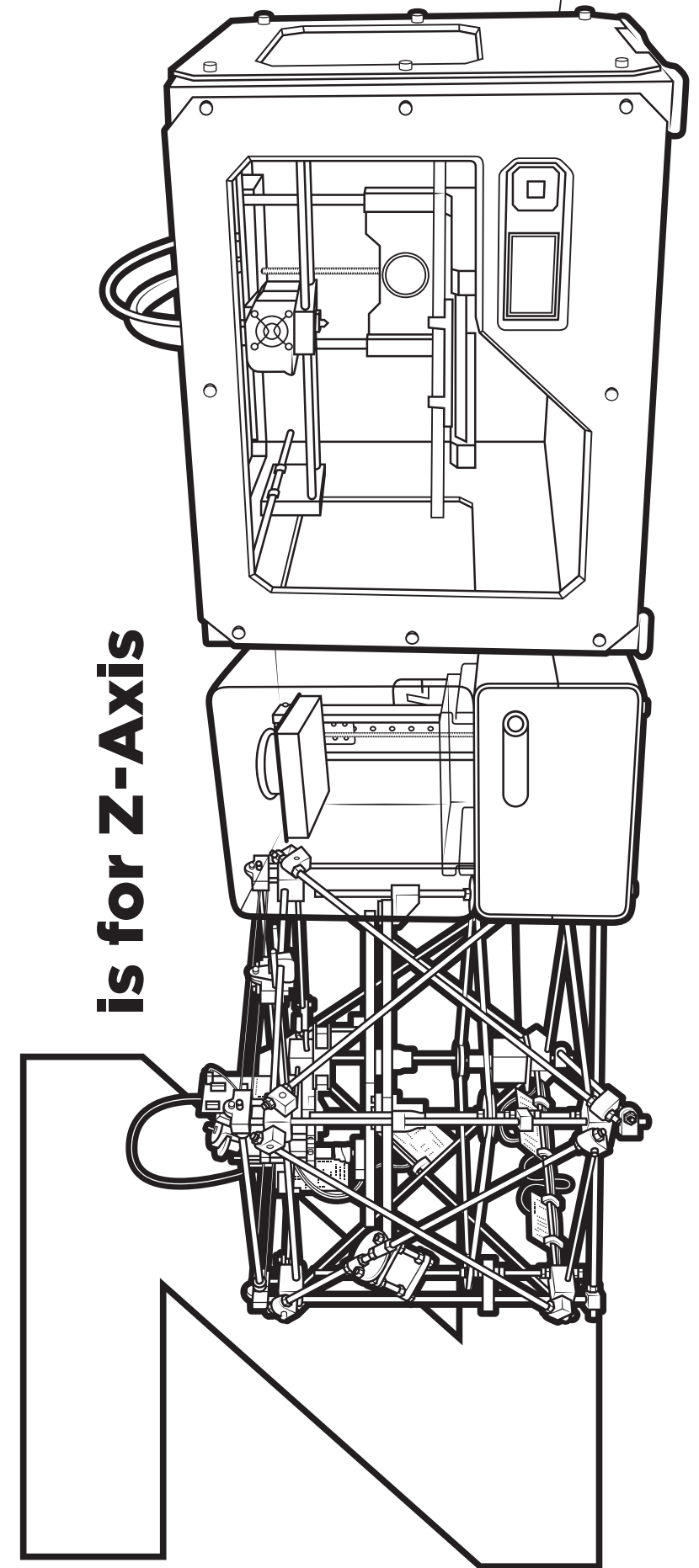

is for Z-Axis