



ZED-F9P

u-blox F9 high precision GNSS module

Integration Manual

Abstract

This document describes the features and specifications of ZED-F9P, a multi-band GNSS module offering centimeter level accuracy with integrated RTK.

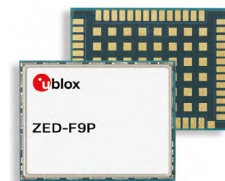

Document Information

Title	ZED-F9P		
Subtitle	u-blox F9 high precision GNSS module		
Document type	Integration Manual		
Document number	UBX-18010802		
Revision and date	R02		03-Oct-2018
Document Status	Advance Information		

This document applies to the following products:

Product name	Type number	Firmware version	PCN reference
ZED-F9P	ZED-F9P-00B-00	HPG 1.00	N/A

u-blox reserves all rights to this document and the information contained herein. Products, names, logos and designs described herein may in whole or in part be subject to intellectual property rights. Reproduction, use, modification or disclosure to third parties of this document or any part thereof without the express permission of u-blox is strictly prohibited.

The information contained herein is provided "as is" and u-blox assumes no liability for the use of the information. No warranty, either express or implied, is given with respect to, including but not limited to, the accuracy, correctness, reliability and fitness for a particular purpose of the information. This document may be revised by u-blox at any time. For most recent documents, please visit www.u-blox.com.

Copyright © 2018, u-blox AG.

u-blox is a registered trademark of u-blox Holding AG in the EU and other countries.

Contents

1 Overview.....	7
1.1 Real Time Kinematic.....	7
1.1.1 RTK modes of operation.....	7
1.2 Typical ZED-F9P application setups.....	8
1.2.1 ZED-F9P in a drone application.....	8
1.2.2 ZED-F9P in a robotic mower application.....	9
2 Integration manual structure.....	10
3 Getting started.....	11
3.1 RTCM corrections.....	12
3.2 List of supported RTCM input messages.....	13
3.3 List of supported RTCM output messages.....	14
3.4 NTRIP - Networked Transport of RTCM via Internet Protocol.....	14
3.5 Configuration of the base and rover for RTK operation.....	15
3.5.1 Time mode configuration on the base.....	15
3.5.2 Required configuration of the base and rover.....	16
3.5.3 Communication interface configuration.....	17
3.5.4 Message output configuration.....	17
3.5.5 Base station: RTCM output configuration.....	18
3.5.6 Base and rover: UBX output configuration.....	18
3.5.7 Base station: Mode configuration.....	18
3.5.8 Base station: Configuration procedure in u-center overview.....	20
3.5.9 Rover: Configuration procedure in u-center overview.....	24
3.5.10 RTK rover mode output in messages.....	28
3.6 Default GNSS configuration.....	28
3.7 Default messages.....	29
4 Receiver description.....	30
4.1 Receiver configuration.....	30
4.2 Changing configuration.....	30
4.3 Basic receiver configuration.....	30
4.3.1 Communication interface configuration.....	30
4.3.2 Message output configuration.....	30
4.3.3 GNSS signal configuration.....	31
4.3.4 Antenna supervisor configuration.....	32
4.4 Legacy configuration interface compatibility.....	33
4.5 Serial Communication Ports Description.....	33
4.5.1 TX-ready indication.....	33
4.5.2 Extended TX timeout.....	34
4.5.3 UART Ports.....	34
4.5.4 USB Port.....	34
4.5.5 DDC Port.....	35
4.5.6 SPI Port.....	38
4.6 Multiple GNSS Assistance (MGA).....	39
4.6.1 AssistNow Online.....	39
4.6.2 Host software.....	40

4.6.3 AssistNow Online sequence.....	40
4.6.4 Flow control.....	41
4.6.5 Authorization.....	41
4.6.6 Service parameters.....	41
4.6.7 Multiple servers.....	43
4.7 Broadcast navigation data.....	43
4.7.1 Parsing navigation data subframes.....	43
4.7.2 GPS.....	44
4.7.3 GLONASS.....	45
4.7.4 BeiDou.....	46
4.7.5 Galileo.....	46
4.7.6 QZSS.....	48
4.7.7 Summary.....	49
4.8 Clocks and time.....	49
4.8.1 Receiver local time.....	49
4.8.2 Navigation epochs.....	49
4.8.3 iTOW timestamps.....	50
4.8.4 GNSS times.....	51
4.8.5 Time validity.....	51
4.8.6 UTC representation.....	51
4.8.7 Leap seconds.....	52
4.8.8 Real time clock.....	52
4.8.9 Date.....	52
4.9 Navigation configuration settings description.....	53
4.9.1 Platform settings.....	53
4.9.2 Navigation input filters.....	54
4.9.3 Navigation output filters.....	54
4.9.4 Static hold.....	55
4.9.5 Freezing the course over ground.....	57
4.9.6 Degraded navigation.....	58
4.10 Time pulse.....	58
4.10.1 Introduction.....	58
4.10.2 Recommendations.....	59
4.10.3 GNSS time bases.....	60
4.10.4 Time pulse configuration.....	60
4.10.5 Configuring time pulse with CFG-TP-*.....	61
4.11 Forcing a receiver reset.....	62
4.12 Geofencing.....	63
4.12.1 Introduction.....	63
4.12.2 Interface.....	63
4.12.3 Geofence state evaluation.....	63
4.12.4 Using a PIO for geofence state output.....	64
4.13 Receiver status monitoring.....	64
4.13.1 Input/output system.....	64
4.13.2 Jamming/interference indicator.....	64
4.13.3 Jamming/interference monitor (ITFM).....	65
4.14 Host interface signature description.....	65
4.14.1 Introduction.....	65
4.14.2 Configuring the fixed seed and register messages.....	66
4.14.3 Configuring the dynamic seed.....	66

4.14.4 Parsing the signature.....	66
4.14.5 Calculate the hash.....	66
4.15 Spoofing detection.....	67
4.15.1 Introduction.....	67
4.15.2 Scope.....	67
4.16 Timemark.....	67
5 Hardware description.....	69
5.1 Block diagram.....	69
5.2 Connecting power.....	69
5.2.1 VCC: Main supply voltage.....	69
5.2.2 V_BCKP: Backup supply voltage.....	70
5.2.3 ZED-F9P Power supply.....	70
5.3 Interfaces.....	71
5.3.1 UART interfaces.....	72
5.3.2 SPI interface.....	73
5.3.3 D_SEL interface.....	73
5.3.4 RESET_N interface.....	73
5.3.5 SAFEBOOT_N interface.....	73
5.3.6 TIMEPULSE interface.....	73
5.3.7 TX_READY interface.....	73
5.3.8 USB interface.....	73
5.3.9 Display Data Channel (DDC).....	75
5.3.10 Antenna supervisor.....	75
5.3.11 EXTINT.....	78
6 EOS/ESD precautions.....	79
6.1 ESD handling precautions.....	79
6.2 ESD protection measures.....	79
6.3 EOS precautions.....	80
6.4 Safety precautions.....	80
7 Electromagnetic interference on I/O lines.....	81
7.1 General notes on interference issues.....	81
7.2 In-band interference mitigation.....	82
7.3 Out-of-band interference.....	82
8 Design.....	83
8.1 Pin assignment.....	83
8.2 RF front-end circuit options.....	85
8.3 Antenna.....	86
8.4 Stacked patch antenna.....	87
8.5 ZED-F9P minimal design.....	91
8.6 ZED-F9P antenna bias.....	92
8.7 Layout.....	93
8.7.1 Placement.....	93
8.7.2 Package footprint, copper and solder mask.....	94
8.8 Layout guidance.....	97
8.8.1 RF In trace.....	97
8.8.2 Vias for the ground pads.....	99
8.8.3 VCC pads.....	99
8.9 Design in checklist.....	100

8.9.1 General considerations.....	100
8.9.2 Back up battery.....	100
8.9.3 Antenna/ RF input.....	101
8.9.4 ZED-F9P ground pads.....	101
8.9.5 Schematic design-in.....	101
8.9.6 Pin assignment.....	101
8.9.7 Layout design-in checklist.....	103
9 Product handling.....	104
9.1 Soldering.....	104
9.2 Tapes.....	106
9.3 Reels.....	108
9.4 Moisture Sensitivity Levels.....	108
10 Appendix.....	109
10.1 RTCM ITRF Geodetic models.....	109
10.2 Virtual Reference Station.....	110
11 Related documents.....	112
12 Revision history.....	113

1 Overview

The ZED-F9P positioning module features the new u-blox F9 receiver platform, which provides multi-band GNSS to high volume industrial applications in a compact form factor. The module with integrated RTK enables precise navigation and automation of moving machinery in industrial and consumer grade products in a small surface mounted form factor.

Following u-blox's proven strategy of bringing high-performance GNSS technology to mass markets, the ZED-F9P incorporates u-blox's new F9 multi-band platform in a tiny SMD form-factor of only 17.0 x 22.0 x 2.4 mm.

1.1 Real Time Kinematic

u-blox ZED-F9P takes GNSS precision to the next level:

- Delivers accuracy down to the centimeter-level: 0.01m + 1 ppm CEP
- Fast time to first fix and robust performance with multi-band, multi-constellation reception
- Compatible with leading correction services for global coverage and versatility

Some typical applications for the ZED-F9P are shown below:



Figure 1: Typical applications for the ZED-F9P

1.1.1 RTK modes of operation

The ZED-F9P supports two modes of operation:

1. ZED-F9P operating as a base: It provides RTCM corrections to a ZED-F9P rover, or to a network of ZED-F9P rovers.
2. ZED-F9P operating as a rover: receiving RTCM corrections from a ZED-F9P operating as a base. It receives RTCM corrections from a ZED-F9P operating as a base, RTCM corrections from a Network RTK system.

If two ZED-F9P are used locally together with one supplying the RTCM corrections they are known as a base and rover. If a rover is receiving corrections via NTRIP from a service it is receiving these corrections from a "reference receiver".

1.2 Typical ZED-F9P application setups

Two application examples have been illustrated as typical system implementations. Both are representative of a simple "short baseline" set-up in which the Base and Rover receivers are within a few hundred meters of each other. Here the ZED-F9P is used as a base station providing corrections to a mobile rover receiver.

Alternatively, the rover can use corrections provided over longer baselines from a correction stream distributed as a subscription service. This method can use a single fixed reference source which is local (within 50km) to the rover receiver or via a Virtual Reference Service (VRS) in which corrections are synthesized for the rovers location.

1.2.1 ZED-F9P in a drone application

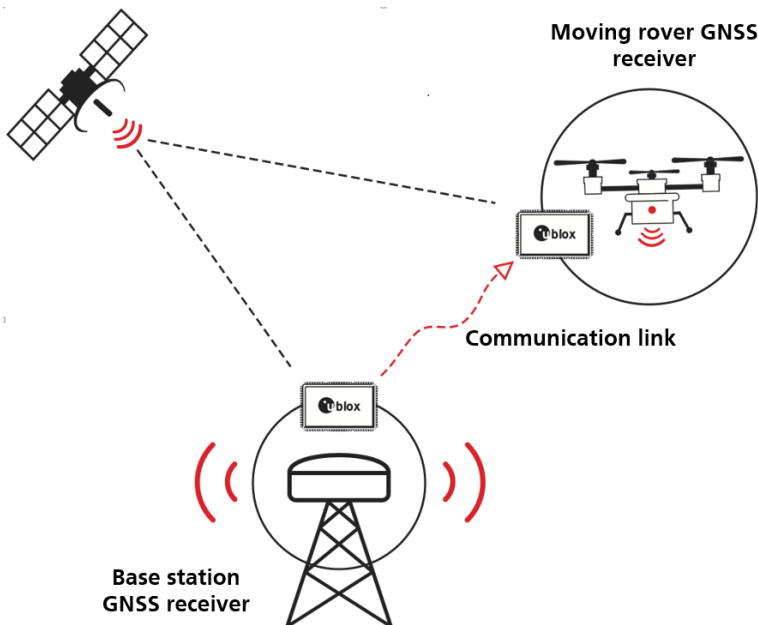

Figure 2: ZED-F9P base and rover in a short baseline drone application

1.2.2 ZED-F9P in a robotic mower application

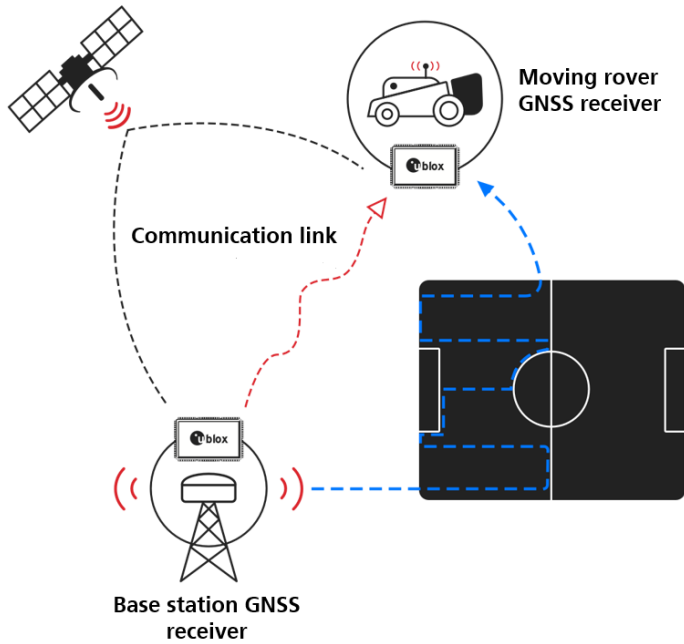

Figure 3: ZED-F9P base and rover in a short baseline robotic mower application

2 Integration manual structure

This document provides a wealth of information to enable a successful ZED-F9P module implementation. The manual is structured into three main parts covering system, software and hardware aspects.

The first section, "Getting started" outlines the basics of enabling RTK operation with the ZED-F9P. This is essential reading for anyone new to the device to enable them to get a working RTK application up and running.

The following section "Receiver description" provides an exhaustive description of the receivers functionality. Beginning with the new configuration concept both existing and new users should read this section to understand the new methods employed. Most of the following sub-sections should be familiar to existing users of u-blox positioning products, however some changes are introduced owing to the new configuration concept.

The sections from the "Hardware description" onwards addresses the HW engineers options when designing the ZED-F9P into a new product. The "Hardware description" section addresses power supply considerations and peripheral interfacing. The "Design" section goes into further details and provides guidance for circuit design and PCB lay-out assistance. An important part of a RTK system is the antenna, this is detailed in the "Antenna" section following the "RF front-end circuit options" section. Finally we have a "Design in checklist" section that can be used to check that the important parts of the design in process have been carried out.

3 Getting started

This part provides the key requirements for enabling RTK operation with the ZED-F9P. Following an overview of RTCM message support and basic receiver configuration the user is guided through the procedures needed to establish RTK base or rover operation.

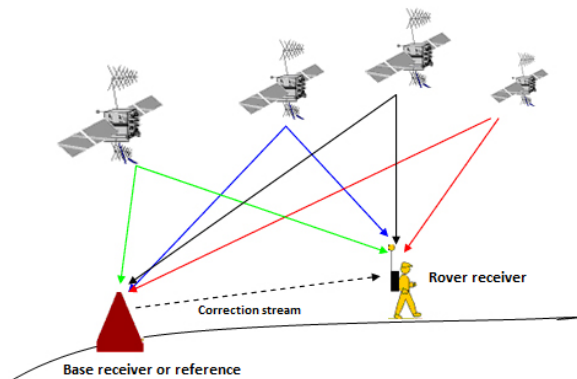

Figure 4: RTK system in a nutshell

The RTK rover needs RTCM corrections in order to achieve high precision results. These corrections come from a local receiver (the base), or via a reference receiver. If the two receivers are local to each other they are called the base and rover. If the rover is provided its corrections from a system such as VRS/CORS it is provided its corrections from a service or reference receiver.

The corrections can be supplied to the ZED-F9P using several interfaces: UART, I2C, SPI, USB.

The link between the rover and the source of the corrections can be any form of wireless link: Cellular, WIFI, Bluetooth, proprietary radio, ISM etc. The user only needs to ensure the RTCM messages arrive at the I/O port selected on the ZED-F9P. This link will be bi-directional for a VRS services as the rover has to provide its position usually every 30 seconds at least.

Instead of using two local receivers in a base and rover configuration you can use a correction service that can be accessed over the internet. The rover receives corrections in RTCM format that are provided over the internet via a NTRIP service. This requires that an NTRIP client processes the corrections from an NTRIP server on the internet. This client will be implemented on a host application connected to the rover. There are many open source variants of NTRIP clients available that can be implemented on embedded or Windows, Linux, Android systems.

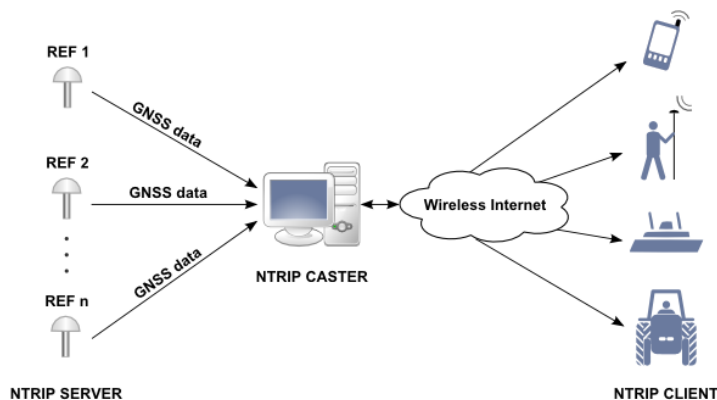

Figure 5: NTRIP system

First it is important to ensure the rover is receiving the right RTCM messages. In the following sections we cover the minimum recommended RTCM messages for a rover receiver. If a ZED-F9P is used as a local base supplying corrections we list the minimum recommended messages to enable for operation.

When using a ZED-F9P rover with a correction service or other survey grade receiver it is important to ensure that the rover is receiving supported messages. A list of supported RTCM messages is provided to check against those provided by a chosen correction stream.

3.1 RTCM corrections

The ZED-F9P high precision receiver must receive RTCM corrections for all GNSS constellations that it receives in order to function as an RTK rover. The ZED-F9P high precision receiver needs to output RTCM corrections if being used as an RTK base. The correct RTCM messages must also be selected for the GNSS constellations and signals being received. The supported input and output messages are listed in the following sections.



RTCM is a binary data protocol for communication of GNSS correction information. The ZED-F9P high precision receiver supports RTCM as specified by RTCM 10403.3, Differential GNSS (Global Navigation Satellite Systems) Services – Version 3 (October 7, 2016).

For rover configuration with the default GNSS configuration, the recommended list of RTCM input messages are:

- RTCM 1005
- RTCM 1074
- RTCM 1084
- RTCM 1094
- RTCM 1124
- RTCM 1230

For base configuration with the default GNSS configuration, the recommended list of RTCM output messages are:

- RTCM 1005
- RTCM 1074

- RTCM 1084
- RTCM 1094
- RTCM 1124
- RTCM 1230

 The update rate of the base receiver must not be higher than that of the rover for the best handling of cyclic slip information in the RTCM corrections.

 The RTCM specification is currently at version 3.3. Note that RTCM version 2x messages are not supported by this standard.

You can download the standard from the RTCM website [here](#).

To modify the RTCM input/output settings, see the Configuration section in the u-blox ZED-F9P Interface Description [2].

 See the RTCM ITRF Geodetic models section in the Appendix for more information. Users should be aware of the datum provided by the RTCM correction source. This may need to be taken into account when using the RTK rover position coordinates.

3.2 List of supported RTCM input messages

Message	Description
RTCM 1001	L1-only GPS RTK observables
RTCM 1002	Extended L1-only GPS RTK observables
RTCM 1003	L1/L2 GPS RTK observables
RTCM 1004	Extended L1/L2 GPS RTK observables
RTCM 1005	Stationary RTK reference station ARP
RTCM 1006	Stationary RTK reference station ARP with antenna height
RTCM 1007	Antenna descriptor
RTCM 1009	L1-only GLONASS RTK observables
RTCM 1010	Extended L1-only GLONASS RTK observables
RTCM 1011	L1/L2 GLONASS RTK observables
RTCM 1012	Extended L1/L2 GLONASS RTK observables
RTCM 1033	Receiver and Antenna Description
RTCM 1074	GPS MSM4
RTCM 1075	GPS MSM5
RTCM 1077	GPS MSM7
RTCM 1084	GLONASS MSM4
RTCM 1085	GLONASS MSM5
RTCM 1087	GLONASS MSM7
RTCM 1094	Galileo MSM4
RTCM 1095	Galileo MSM5
RTCM 1097	Galileo MSM7
RTCM 1124	BeiDou MSM4
RTCM 1125	BeiDou MSM5
RTCM 1127	BeiDou MSM7
RTCM 1230	GLONASS code-phase biases

Table 1: ZED-F9P supported input RTCM version 3.3 messages

3.3 List of supported RTCM output messages

Message	Description
RTCM 1005	Stationary RTK reference station ARP
RTCM 1074	GPS MSM4
RTCM 1077	GPS MSM7
RTCM 1084	GLONASS MSM4
RTCM 1087	GLONASS MSM7
RTCM 1094	Galileo MSM4
RTCM 1097	Galileo MSM7
RTCM 1124	BeiDou MSM4
RTCM 1127	BeiDou MSM7
RTCM 1230	GLONASS code-phase biases

Table 2: ZED-F9P supported output RTCM version 3.3 messages

The configuration of the RTCM 3x correction stream must be done according to the following rules:

- All observation messages must be broadcast at the same rate.
- The reference station ID field in the GPS, GLONASS, Galileo, BeiDou observation messages must be consistent with the reference station ID field in the reference station message otherwise the rover will not be able to compute its position.
- The RTCM 3x stream must contain the "GLONASS code-phase biases" message (type 1230) or the "Receiver and Antenna Description" message (type 1033) otherwise the GLONASS ambiguities can only be estimated as float, even in RTK fixed mode. If using a ZED-F9P as a base, "GLONASS code-phase biases" message (type 1230) must be enabled to be output. For a ZED-F9P being used as a rover if no RTCM 1230 message is received, or if the reference receiver type reported in RTCM 1033 message is unknown to the ZED-F9P receiver, the ZED-F9P rover will only be able to estimate GLONASS ambiguities as float, even in RTK fixed mode. This will result in degraded performance, especially in challenging environments.
- The static reference station message (type 1005 or type 1006) does not need to be broadcast at the same rate as the observation messages however the rover will not be able to compute its position until it has received a valid reference station message.
- The RTCM 3x stream should only contain one type of observation messages per constellation. When using a multi-constellation configuration, all constellations should use the same type of observation messages. Mixing RTK and MSM messages will result in undefined rover behavior.
- If the receiver is configured to output RTCM messages on several ports, they must all have the same RTCM configuration otherwise the MSM multiple message bit might not be set properly.

3.4 NTRIP - Networked Transport of RTCM via Internet Protocol

Networked Transport of RTCM via Internet Protocol, or NTRIP, is a standard protocol for streaming differential data over the internet in accordance with specifications published by RTCM.

This is a convenient method used by many commercial service providers for distributing corrections.

There are three major parts to the NTRIP system: The NTRIP client, the NTRIP server, and the NTRIP caster:

1. The NTRIP server is a PC or on-board computer running NTRIP server software communicating directly with a GNSS reference station. The NTRIP server serves as the intermediary between the GNSS receiver (NTRIP Source) streaming RTCM data and the NTRIP caster.
2. The NTRIP caster is a HTTP server which receives streaming RTCM data from one or more NTRIP servers and in turn streams the RTCM data to one or more NTRIP clients via the internet.

3. The NTRIP client receives streaming RTMC data from the NTRIP caster to apply as real-time corrections to a GNSS rover .

u-center provides a NTRIP client and server application that can be used to easily evaluate a ZED-F9P base or rover. Typically a u-center NTRIP client connects over the internet to a NTRIP service provider. The u-center NTRIP client then provides the RTCM 3x corrections to a ZED-F9P rover connected to the local u-center application. VRS is also supported by the u-center NTRIP client.

The relevant RTCM standard NTRIP version 2 can be downloaded from the RTCM standards website: [NTRIP](#).

3.5 Configuration of the base and rover for RTK operation

The configuration settings are modified using UBX protocol configuration messages. For more information, see the Receiver Configuration and CFG Interface sections in the ZED-F9P Interface Description [2]. If stored in RAM, then the modified settings remain effective until power-down or reset. If these settings have been stored in BBR (Battery Backed RAM), then the modified configuration will be used as long as the backup battery supply is not removed or interrupted. The configuration can be saved permanently in flash memory. The messages that are used to change or verify the configuration are the UBX-CFG-VALSET, UBX-CFG-VALGET, and UBX-CFG-VALDEL messages. See the u-blox ZED-F9P Interface Description [2]. u-center 18.05 or later has support for these messages.

With the new configuration concept a configuration group is identified as CFG-GROUP-*

Within a configuration group there is a configuration item: CFG-GROUP-ITEM.

This configuration item is also known as the "key name" as identified within u-center "Message view", CFG-VALSET message window.

Within u-center, "Generation 9 Configuration View" - "Advanced Configuration" view. The configuration group is identified as "Group name", the configuration item is identified as the "item name".

In this chapter these terms are used in this concept

3.5.1 Time mode configuration on the base

This section relates to the configuration item: CFG-TMODE-MODE for putting the ZED-F9P base receiver into the correct RTK mode to provide corrections to a ZED-F9P rover.

3.5.1.1 Introduction

Time Mode is a receiver mode where the position of the receiver is known and fixed and only the time is calculated using all available satellites. This mode allows for using the receiver as a stationary base station.

There are two possible modes: Fixed mode or survey-in.

3.5.1.2 Fixed position

In order to use the Time Mode, the receiver's position must be known as accurately as possible. Either the user already knows and enters the position, or it is determined using Survey-in. Errors in the fixed position will translate into time errors depending on the satellite constellation.

Errors in the base station position will directly translate into rover position errors. The base station position accuracy should therefore be at least as good as the desired rover absolute position accuracy.

3.5.1.3 Survey-in

Survey-in is the procedure that is carried out prior to using Time Mode. It determines a stationary receiver's position by building a weighted mean of all valid 3D position solutions.

Two requirements for stopping the procedure must be specified:

- The minimum observation time defines a minimum amount of observation time regardless of the actual number of valid fixes that were used for the position calculation. Reasonable values range from one day for high accuracy requirements to a few minutes for coarse position determination.
- The required 3D position standard deviation defines a limit on the spread of positions that contribute to the calculated mean.

Survey-in ends, when both requirements are met. After Survey-in has finished successfully, the receiver will automatically enter fixed position Time Mode.

The Survey-in status can be queried using the UBX-NAV-SVIN message:

- The "Standard Deviation" parameter defines uncertainty of the manually provided "True Position" set of parameters. This uncertainty directly affects the rover absolute position accuracy. This is to prevent an error that would otherwise be present in the rover absolute position because of the initially inaccurate position (assumed to be correct by the receiver) without users being aware of it. The "3D accuracy" parameter in "Fixed Position" as well as the "Position accuracy limit" in "Survey-in" affect the produced rover absolute position accuracy in the same way. Note that the availability of the position accuracy does not mitigate the error in the rover position, but only accounts for it when calculating the resulting positioning accuracy.

3.5.2 Required configuration of the base and rover

This section describes how to configure the base station and the rover in detail.

3.5.2.1 Base station configuration

Base Station receiver mode is where the receiver makes measurements of all available satellites to broadcast corrections. Configuring a stationary base station is done in two steps:

- The receiver must be set in Time Mode using the configuration steps described in the Time Mode Configuration section (CFG-TMODE-MODE).
- The RTCM 3x correction stream must be configured following the rules detailed in the Base station: RTCM output configuration section. Each RTCM message must be individually enabled using CFG-MSGOUT-* configuration group.

By default the base station will begin operation in standard GNSS mode without any RTCM output. Messages for observations will be streamed as soon as they are configured for output. However messages for the base station position will only be output when both the base station is in fixed position mode, and the message is configured for output. As explained in the Time Mode Configuration section, this mode can be directly configured or reached at the end of a successful survey-in.

The rover will need to have received both base station observation messages and base station position messages in order to attempt ambiguity fixes.

3.5.2.2 Rover configuration

The RTK rover can be configured to work in either of these two differential modes using configuration item CFG-NAVHPG-DGNSSMODE:

- RTK fixed: In this mode, the rover will attempt to fix ambiguities whenever possible.
- RTK float: In this mode, the rover will estimate the ambiguities as float but will make no attempts at fixing them.

The time after which old RTCM data will be discarded can be specified using the `dgnsstimeout` field in configuration item `CFG-NAVSPG-CONSTR_DGNSSTO`.

By default the rover will begin operation in RTK fixed mode. Upon receiving an RTCM 3x correction stream on any of its communication interfaces, the rover will parse the data, apply the correction and, if possible, fix ambiguities. In absence of correction data or if the correction data times out, the rover will operate in standard GNSS mode.



The time needed to resolve the ambiguity is affected by the baseline length as well as by multipath and satellite visibility at both rover and base station.

3.5.3 Communication interface configuration

It is possible to configure the communication interfaces of a base station or a rover. This is done by setting the appropriate configuration items by using the `CFG-UART1*`, `CFG-UART2*`, `CFG-I2C*`, `CFG-SPI*`, `CFG-USB*` configuration groups. Several configuration items allow configuring the operation modes of the different communications interfaces. This includes parameters for the data framing, transfer rate and protocols used. A subset of the relevant configuration items is seen below for the UART1 only. For all available configuration items, see ZED-F9P Interface Description [2].

Configuration item	Description
<code>CFG-UART1-BAUDRATE</code>	The baud rate that should be configured on the UART1
<code>CFG-UART1INPROT-UBX</code>	Flag to indicate if UBX should be an input protocol on UART1
<code>CFG-UART1INPROT-NMEA</code>	Flag to indicate if NMEA should be an input protocol on UART1
<code>CFG-UART1INPROT-RTCM3X</code>	Flag to indicate if RTCM3X should be an input protocol on UART1
<code>CFG-UART1OUTPROT-UBX</code>	Flag to indicate if UBX should be an output protocol on UART1
<code>CFG-UART1OUTPROT-NMEA</code>	Flag to indicate if NMEA should be an output protocol on UART1
<code>CFG-UART1OUTPROT-RTCM3X</code>	Flag to indicate if RTCM3X should be an output protocol on UART1

Table 3: Typical configuration items used for UART1 baudrate and protocol configuration

-  The default communication configuration of the UART1 port is set at a baud rate of 38400 baud with NMEA messages being output. The module will respond to incoming UBX binary commands. To see all the default configuration settings, see the u-blox ZED-F9P Interface Description [2].
-  If the navigation rate of the rover is increased, the UART baud rate should be increased to account for the additional data transferred. A baud rate of 460800 baud is recommended for high update rates with the minimum required messages enabled.
-  The default baud rate of 38400 baud should be increased to allow for increased capacity over the UART interface if UBX messages, RAW data or debug messages are enabled, again a baud rate of 230400 baud to 460800 baud is recommended in this case.

3.5.4 Message output configuration

It is possible to configure the rate of NMEA, UBX and RTCM protocol output messages of a base station or a rover. If the rate configuration value is zero, the corresponding message will not be output. Values greater than zero indicate how often the message is output. Note that all message output is additionally subject to the protocol configuration of the communication interfaces. Messages of a given protocol will not be output until the protocol is enabled for output on the interface.

Setting the appropriate configuration items is done by using the `CFG-MSGOUT-*` configuration group. Several configuration items allow configuring the message output rates per message and per communication interface. For all for available configuration items, see the `CFG-MSGOUT-*` configuration group in ZED-F9P Interface Description [2].

3.5.5 Base station: RTCM output configuration

To enable a base station to output the recommended RTCM messages, configuration items need to be set using the appropriate CFG-MSGOUT-RTCM_3X* configuration item. Below are the relevant configuration items for the UART1 interface:

Configuration item	Description
CFG-MSGOUT-RTCM_3X_TYPE1005_UART1	Output rate of the RTCM-3X-TYPE1005 message on port UART1: RTCM Base station message
CFG-MSGOUT-RTCM_3X_TYPE1074_UART1	Output rate of the RTCM-3X-TYPE1074 message on port UART1: RTCM GPS MSMS4 message
CFG-MSGOUT-RTCM_3X_TYPE1084_UART1	Output rate of the RTCM-3X-TYPE1084 message on port UART1: RTCM Glonass MSM4 message
CFG-MSGOUT-RTCM_3X_TYPE1094_UART1	Output rate of the RTCM-3X-TYPE1094 message on port UART1: RTCM Galileo MSM4 message
CFG-MSGOUT-RTCM_3X_TYPE1124_UART1	Output rate of the RTCM-3X-TYPE1124 message on port UART1: RTCM Beidou MSM4 message
CFG-MSGOUT-RTCM_3X_TYPE1230_UART1	Output rate of the RTCM-3X-TYPE1230 message on port UART1: RTCM Glonass bias message

Table 4: Configuration items used for typical RTCM output configuration on UART1

3.5.6 Base and rover: UBX output configuration

To enable a base or rover to output the recommended UBX messages, configuration items need to be set using the appropriate CFG-MSGOUT-UBX* configuration item. Below are the relevant configuration items for the UART1 interface:

Configuration item	Description
CFG-MSGOUT-UBX_NAV_SAT_UART1	Output rate of the UBX-NAV-SAT message on port UART1
CFG-MSGOUT-UBX_NAV_SIG_UART1	Output rate of the UBX-NAV-SIG message on port UART1
CFG-MSGOUT-UBX_NAV_POSLLH_UART1	Output rate of the UBX-NAV-POSLLH message on port UART1
CFG-MSGOUT-UBX_NAV_PVT_UART1	Output rate of the UBX-NAV-PVT message on port UART1
CFG-MSGOUT-UBX_NAV_RELPOSNED_UART1	Output rate of the UBX-NAV-RELPOSNED message on port UART1
CFG-MSGOUT-UBX_NAV_STATUS_UART1	Output rate of the UBX-NAV-STATUS message on port UART1
CFG-MSGOUT-UBX_NAV_SVIN_UART1	Output rate of the UBX-NAV-SVIN message on port UART1
CFG-MSGOUT-UBX_RXM_RTCM_UART1	Output rate of the UBX-RXM-RTCM message on port UART1

Table 5: Configuration items used for recommended UBX output configuration on UART1

3.5.7 Base station: Mode configuration

To set a ZED-F9P as a base station, it is necessary to set its coordinates. Once this is done, the ZED-F9P will operate as a base station and output the configured stream of RTCM messages.

To set a base station to survey-in mode (CFG-TMODE-MODE=SURVEY_IN), the relevant configuration items below need to be set:

Configuration item	Description
CFG-TMODE-MODE	Receiver mode (disabled or survey-in or fixed)
CFG-TMODE-SVIN_MIN_DUR	Survey-in minimum duration

Configuration item	Description
CFG-TMODE-SVIN_ACC_LIMIT	Survey-in position accuracy limit

Table 6: Configuration items used for setting a base station into survey-in

 Both requirements (duration time and accuracy limit) must be met before the base station completes the survey-in process. Once this is done then it will begin to output the base position message RTCM 1005. The rover will not be able to enter RTK Fixed mode unless it is receiving RTCM 1005.

There are 3 possible ways to initialize the base station position:

- Use base survey-in to estimate the approximate position.
- Use base fixed position mode where the known accurate position of the base is entered such as from a survey marker.
- Use rover mode and feed the unit RTCM 3x corrections from a service. Then this estimated RTK position is used to enter the base into fixed mode with these coordinates.

 The base station receiver should not be fed RTCM correction while it is in survey-in mode. Instead, the base station coordinates should be pre-surveyed using RTCM correction and then, these coordinates should be used to set the base station in fixed mode.

To set a base station into fixed mode (CFG-TMODE-MODE=FIXED), the relevant configuration items below need to be set:

Configuration item	Description
CFG-TMODE-MODE	Receiver mode (disabled or survey-in or fixed)
CFG-TMODE-POS_TYPE	Determines whether the ARP position is given in ECEF or LAT/LON/HEIGHT
CFG-TMODE-ECEF_X	ECEF X coordinate of the ARP position
CFG-TMODE-ECEF_Y	ECEF Y coordinate of the ARP position
CFG-TMODE-ECEF_Z	ECEF Z coordinate of the ARP position
CFG-TMODE-LAT	Latitude of the ARP position
CFG-TMODE-LON	Longitude of the ARP position
CFG-TMODE-HEIGHT	Height of the ARP position
CFG-TMODE-ECEF_X_HP	High-precision ECEF X coordinate of the ARP position
CFG-TMODE-ECEF_Y_HP	High-precision ECEF Y coordinate of the ARP position
CFG-TMODE-ECEF_Z_HP	High-precision ECEF Z coordinate of the ARP position
CFG-TMODE-LAT_HP	High-precision latitude of the ARP position
CFG-TMODE-LON_HP	High-precision longitude of the ARP position
CFG-TMODE-HEIGHT_HP	High-precision height of the ARP position

Table 7: Configuration items used for setting a base station into fixed mode

 The high precision option for each of the position types allows you to enter the value in mm compared to the standard cm value.

Once the receiver is set in Fixed mode, select the position format to use: either LLH or ECEF with optional high precision (mm) coordinates.

For example, with CFG-TMODE-POS_TYPE=ECEF The base antenna position can be entered to cm accuracy using CFG-TMODE-ECEF_X, CFG-TMODE-ECEF_Y, CFG-TMODE-ECEF_Z. For high precision (mm) coordinates use CFG-TMODE-ECEF_X_HP, CFG-TMODE-ECEF_Y_HP, CFG-TMODE-ECEF_Z_HP.

The same applies with CFG-TMODE-POS_TYPE=LLH.



When the receiver is in base station mode, some coarse error check is performed on the entered, or surveyed-in, fixed position. If the results of this check indicates that the fixed position may be incorrect, then a UBX-INF-WARNING message with the text: "Base station position seems incorrect" is issued. This error will not be issued when the coordinates are incorrect by less than approximately 50 m or more than approximately 25 km.



Attention If the base station is moved, survey-in must be repeated to obtain the new coordinates or the fixed mode must be reconfigured using the new coordinates.

3.5.8 Base station: Configuration procedure in u-center overview

This overview describes how to set the base station configuration within the u-center "Message view" window available in versions 18.05 or later. Just select the "UBX-CFG-VALSET" option in the u-center "Message view" tree. Once the window opens select the required "Group" in the "Compose list entry" section. Then an associated key can be selected in the "Key name" pull down menu. Once a configuration key is selected move this to the configuration changes list by clicking "Add to List". Key values can be edited or read from the receiver by clicking on items in the "Configuration changes to send" table.

To configure the module for base station operation use the following procedure:

- Set the UART1 interface for the correct host baud rate.
 - Select Group: CFG-UART1, Key name: CFG-UART1-BAUDRATE. See [Figure 6](#).
 - Add it to the list and highlight it. It will now give you the option of setting the value or reading the current value. See [Figure 7](#).
 - Now add the value, e.g. 230400 baud, into the new Value window that appears below the list. See [Figure 8](#).
 - Now set the configuration by clicking the Send button at the bottom of the message tree view. Remember to set the u-center baud rate to match the value set in the receiver.
- Setting the base station required RTCM message output can be done in one session. Select Group CFG-MSGOUT, Key name: CFG-MSGOUT-RTCM3X and select the UART1 required messages. Add each message to the list and then set the value of each to 1. Then click Send. See [Figure 9](#).
- Select the following UBX messages to view the status of the base station and of the survey-in process. Select Group CFG-MSGOUT, Key name: CFG-MSGOUT-UBX and select the UART1 required messages. Add each message to the list and then set the value of each to 1. Then click Send. See [Figure 10](#).
- Set the unit to base station mode by enabling survey-in or fixed mode by set items from the CFG-TMODE configuration group. See a survey-in example in [Figure 11](#).
- The required settings for survey-in required estimated accuracy and the minimum survey-in time can be set at the same time. A figure of 50000 (0.1 mm x 50000 = 5 m) for estimated accuracy and survey-in time of 60 s is sensible.
- If using the survey-in mode, sensible settings must be selected based on the environment and achievable accuracy in the base location. The base will not typically achieve less than a real 1 m accuracy in good conditions, in obstructed multi-path conditions this figure could be higher and the survey-in time to achieve even the lower accuracy can take longer than expected. The base antenna might need to be moved to a better location or the required accuracy and/or survey-in time might need to be extended. Verify with the survey-in status using the NAV-SVIN message.
- The unit will then output all the messages when it has completed the survey-in or when fixed mode has been enabled with the required base antenna coordinates. See [Figure 12](#) to verify all RTCM messages are being output. RTCM MSG 1005 will **only** be output once survey-in is completed or the Fixed coordinates are entered for the base antenna.
- Once the base has either completed the survey-in or been set into Fixed mode correctly it will indicate TIME mode in the u-center Data view. See in [Figure 13](#).

UBX - CFG (Config) - VALSET (New Configuration)

Compose list entry

Group: CFG-UART1

Key name: CFG-UART1-BAUDRATE

Key ID: 40520001 Add to List

Details

Title: The baud rate that should be configured on the UART1

Description:

Type: U4

Key	Key ID	Type	Value

Remove
Remove all

Value

Read receiver

Layers

Flash BBR RAM

Transaction

No transaction

Figure 6: u-center UBX-CFG-VALSET message view

UBX - CFG (Config) - VALSET (New Configuration)

Compose list entry

Group: CFG-UART1

Key name: CFG-UART1-BAUDRATE

Key ID: 40520001 Add to List

Details

Title: The baud rate that should be configured on the UART1

Description:

Type: U4

Key	Key ID	Type	Value
CFG-UART1-BAUDRATE	0x40520001	U4	-

Remove
Remove all

Value

Read receiver

Layers

Flash BBR RAM

Transaction

No transaction

Figure 7: Example u-center UBX-CFG-VALSET message view when selecting a configuration item

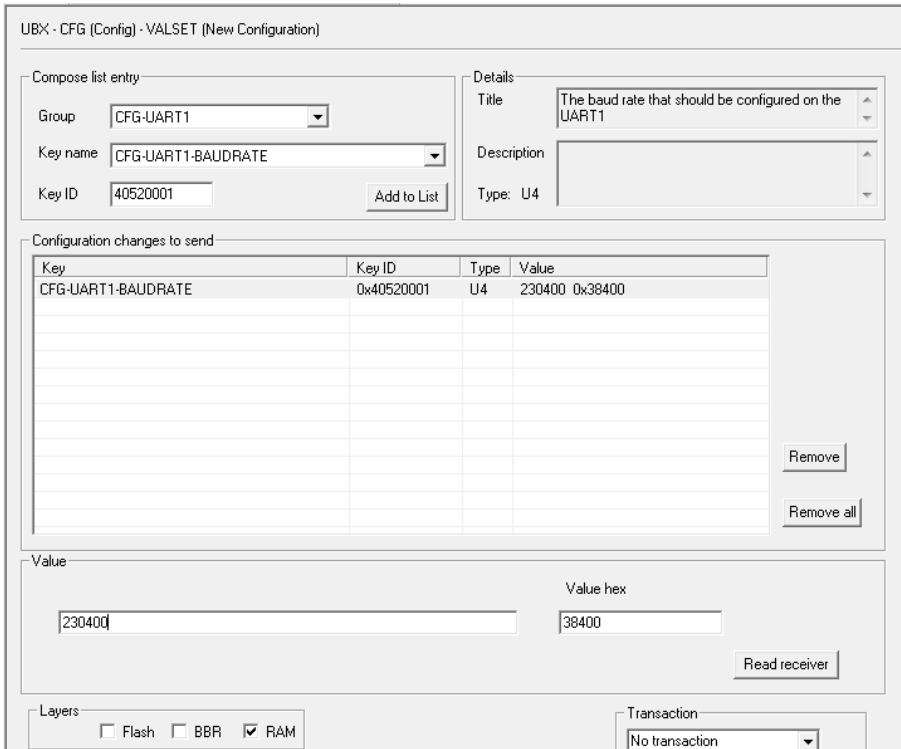

Figure 8: Base station: u-center UBX-CFG-VALSET message view for setting the CFG-UART1-BAUDRATE configuration item that controls the baudrate of UART1



MSM4 messages are done in the same way as the MSM7 RTCM messages, which are shown in the example.

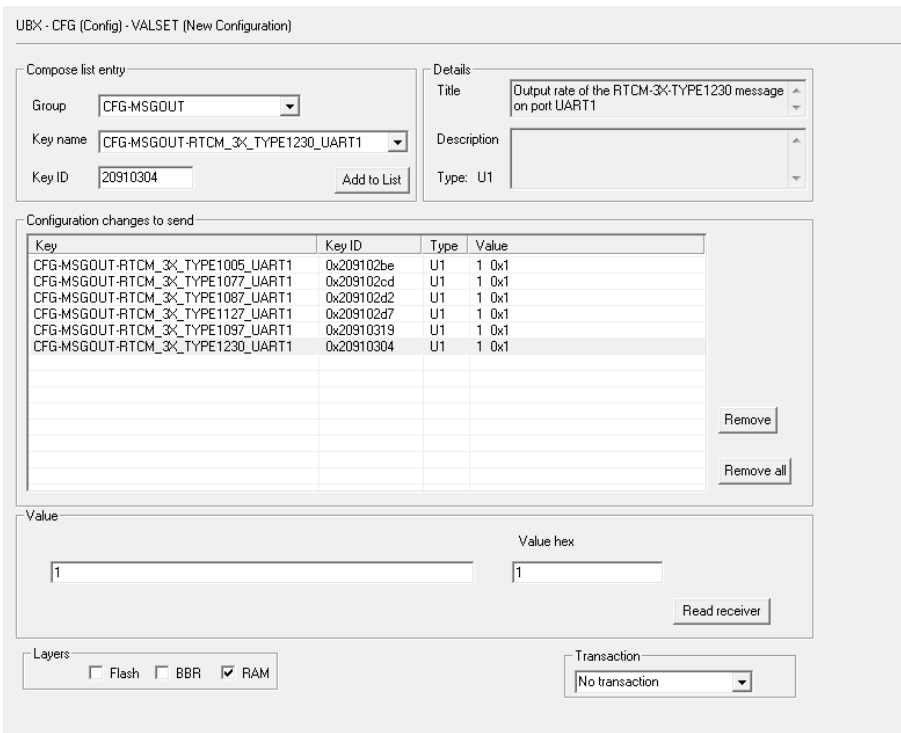

Figure 9: Base station: u-center UBX-CFG-VALSET message view for setting the CFG-MSGGOUT-* configuration group for enabling the output of the required RTCM messages

UBX-NAV-SOL is shown below, however it is not supported with HPG 1.00 firmware.

UBX - CFG (Config) - VALSET (New Configuration)

Compose list entry

Group: CFG-MSGGOUT
 Key name: CFG-MSGGOUT-UBX_NAV_SVIN_UART1
 Key ID: 20910089

Details

Title: Output rate of the UBX-NAV-SVIN message on port UART1
 Description:
 Type: U1

Configuration changes to send

Key	Key ID	Type	Value
CFG-MSGGOUT-UBX_NAV_SIG_UART1	0x20910346	U1	1 0x1
CFG-MSGGOUT-UBX_NAV_SOL_UART1	0x20910002	U1	1 0x1
CFG-MSGGOUT-UBX_NAV_PVT_UART1	0x20910007	U1	1 0x1
CFG-MSGGOUT-UBX_NAV_POSLLH_UART1	0x2091002a	U1	1 0x1
CFG-MSGGOUT-UBX_NAV_RELPOSNED_UART1	0x2091008e	U1	1 0x1
CFG-MSGGOUT-UBX_NAV_STATUS_UART1	0x2091001b	U1	1 0x1
CFG-MSGGOUT-UBX_NAV_SVIN_UART1	0x20910089	U1	1 0x1

Value

Value hex: 1

Layers: Flash BBR RAM

Transaction: No transaction

Figure 10: Base station: u-center UBX-CFG-VALSET message view for setting the CFG-MSGGOUT-* configuration group for enabling the output of some recommended UBX messages

UBX - CFG (Config) - VALSET (New Configuration)

Compose list entry

Group: CFG-TMODE
 Key name: CFG-TMODE-SVIN_MIN_DUR
 Key ID: 40030010

Details

Title: Survey-in minimum duration
 Description: This will only be used if CFG-TMODE-MODE=SURVEY_IN.
 Type: U4

Configuration changes to send

Key	Key ID	Type	Value
CFG-TMODE-MODE	0x20030001	E1	1 - SURVEY_IN
CFG-TMODE-SVIN_ACC_LIMIT	0x40030011	U4	50000 0xc350 mm scaled 0.1
CFG-TMODE-SVIN_MIN_DUR	0x40030010	U4	60 0x3c s

Value

Value hex: 3c

unit: s

Layers: Flash BBR RAM

Transaction: No transaction

Figure 11: Base station: u-center UBX-CFG-VALSET message view for setting the CFG-TMODE-* configuration group required for performing a survey-in

```

Packet Console
14:47:00 R[0] -> RTCM3 1077, Size 300, 'GPS MSM7'
14:47:00 R[0] -> RTCM3 1087, Size 226, 'GLONASS MSM7'
14:47:00 R[0] -> RTCM3 1097, Size 176, 'Galileo MSM7'
14:47:00 R[0] -> RTCM3 1127, Size 208, 'Beidou MSM7'
14:47:00 R[0] -> RTCM3 1230, Size 14, 'GLONASS code-phase biases'
14:47:00 R[0] -> RTCM3 1005, Size 25, 'Stationary RTK reference station ARP'
14:47:00 R[0] -> RTCM3 1077, Size 300, 'GPS MSM7'
14:47:00 R[0] -> RTCM3 1087, Size 226, 'GLONASS MSM7'
14:47:00 R[0] -> RTCM3 1097, Size 176, 'Galileo MSM7'
14:47:00 R[0] -> RTCM3 1127, Size 208, 'Beidou MSM7'
14:47:00 R[0] -> RTCM3 1230, Size 14, 'GLONASS code-phase biases'
14:47:00 R[0] -> RTCM3 1005, Size 25, 'Stationary RTK reference station ARP'
14:47:00 R[0] -> RTCM3 1077, Size 300, 'GPS MSM7'
14:47:00 R[0] -> RTCM3 1087, Size 226, 'GLONASS MSM7'
14:47:00 R[0] -> RTCM3 1097, Size 176, 'Galileo MSM7'
14:47:00 R[0] -> RTCM3 1127, Size 208, 'Beidou MSM7'
14:47:00 R[0] -> RTCM3 1230, Size 14, 'GLONASS code-phase biases'
14:47:00 R[0] -> RTCM3 1005, Size 25, 'Stationary RTK reference station ARP'
14:47:00 R[0] -> RTCM3 1077, Size 300, 'GPS MSM7'
14:47:00 R[0] -> RTCM3 1087, Size 226, 'GLONASS MSM7'
14:47:00 R[0] -> RTCM3 1097, Size 176, 'Galileo MSM7'
14:47:00 R[0] -> RTCM3 1127, Size 208, 'Beidou MSM7'
14:47:00 R[0] -> RTCM3 1230, Size 14, 'GLONASS code-phase biases'
14:47:00 R[0] -> RTCM3 1005, Size 25, 'Stationary RTK reference station ARP'
14:47:00 R[0] -> RTCM3 1077, Size 300, 'GPS MSM7'
14:47:00 R[0] -> RTCM3 1087, Size 226, 'GLONASS MSM7'
14:47:00 R[0] -> RTCM3 1097, Size 176, 'Galileo MSM7'
14:47:00 R[0] -> RTCM3 1127, Size 208, 'Beidou MSM7'
    
```

Figure 12: Base station: u-center packet console RTCM view



If MSM4 RTCM messages are used the output will be similar.

```

Longitude -0.20489633 °
Latitude 51.24183667 °
Altitude 152.500 m
TTFF 32.403 s
Fix Mode TIME
3D Acc. [m] 0 1.08 5
2D Acc. [m] 0 0.88 5
PDOP
HDOP
Satellites ██████████
    
```

Figure 13: Base station: u-center data view in TIME mode

3.5.9 Rover: Configuration procedure in u-center overview

To configure the module for rover operation use the following procedure:

- Set the UART1 interface for the correct host baud rate.
 - Select Group: CFG-UART1, Key name: CFG-UART1-BAUDRATE. See [Figure 14](#).
 - Add it to the list and highlight it. It will now give you the option of setting the value or reading the current value. See [Figure 15](#).
 - Now add the value, e.g. 230400 baud, into the new Value window that appears below the list. See [Figure 16](#).
 - Now set the configuration by clicking the Send button at the bottom of the message tree view. Remember to then set u-center baud rate to match the value you set in the receiver.
- We need to enable some UBX messages to view the status of the rover. Select Group CFG-MSGOUT, Key name: CFG-MSGOUT-UBX and select the UART1 required messages. Add each message to the list and then set the value of each to 1. Then click Send. See [Figure 17](#).

- Ensure all the required RTCM messages, most importantly RTCM 1005, are being received regularly by viewing the messages in the UBX-RXM-RTCM view in u-center. See [Figure 18](#)
- Once the rover has started to receive valid RTCM messages, it will transition from 3D Fix to 3D/DGNSS to Float and to Fixed mode. This will only occur if it is receiving all required RTCM messages, including RTCM 1005, and the signal conditions are sufficient. See [Figure 19](#)
- Note that the receiver by default will attempt a RTK Fix solution, however it can be configured to use an RTK Float only solution by setting the CFG-NAVHPG-DGNSS configuration item.



If using VRS (Virtual Reference Station) the rover must output the NMEA GGA message and this must be returned to the NTRIP caster. If this is not done the NTRIP caster will not provide the rover with correction information. NMEA messages are enabled by default on the UART1, I2C, SPI and USB interface. See the Virtual Reference Station section in the Appendix for more information.

UBX - CFG (Config) - VALSET (New Configuration)

Compose list entry

Group: CFG-UART1
Key name: CFG-UART1-BAUDRATE
Key ID: 40520001

Details

Title: The baud rate that should be configured on the UART1
Description:
Type: U4

Configuration changes to send

Key	Key ID	Type	Value

Value

Layers: Flash BBR RAM

Transaction:

Figure 14: u-center UBX-CFG-VALSET message view

UBX - CFG (Config) - VALSET (New Configuration)

Compose list entry

Group:

Key name:

Key ID:

Details

Title:

Description:

Type: U4

Configuration changes to send

Key	Key ID	Type	Value
CFG-UART1-BAUDRATE	0x40520001	U4	-

Value

Value hex:

Layers: Flash BBR RAM

Transaction:

Figure 15: Example u-center UBX-CFG-VALSET message view when selecting a configuration item

UBX - CFG (Config) - VALSET (New Configuration)

Compose list entry

Group:

Key name:

Key ID:

Details

Title:

Description:

Type: U4

Configuration changes to send

Key	Key ID	Type	Value
CFG-UART1-BAUDRATE	0x40520001	U4	230400 0x38400

Value

Value hex:

Layers: Flash BBR RAM

Transaction:

Figure 16: Rover: u-center UBX-CFG-VALSET message view for setting the CFG-UART1-BAUDRATE configuration item that controls the baudrate of UART1



UBX-NAV-SOL is shown below, however it is not supported with HPG 1.00 firmware.

UBX - CFG (Config) - VALSET (New Configuration)

Compose list entry:

Group: CFG-MSGGOUT
 Key name: CFG-MSGGOUT-UBX_NAV_SVIN_UART1
 Key ID: 20910089 Add to List

Details:

Title: Output rate of the UBX-NAV-SVIN message on port UART1
 Description:
 Type: U1

Configuration changes to send

Key	Key ID	Type	Value
CFG-MSGGOUT-UBX_NAV_SIG_UART1	0x20910346	U1	1 0x1
CFG-MSGGOUT-UBX_NAV_SOL_UART1	0x20910002	U1	1 0x1
CFG-MSGGOUT-UBX_NAV_FVT_UART1	0x20910007	U1	1 0x1
CFG-MSGGOUT-UBX_NAV_POSLLH_UART1	0x2091002a	U1	1 0x1
CFG-MSGGOUT-UBX_NAV_RELPOSNED_UART1	0x2091008e	U1	1 0x1
CFG-MSGGOUT-UBX_NAV_STATUS_UART1	0x2091001b	U1	1 0x1
CFG-MSGGOUT-UBX_NAV_SVIN_UART1	0x20910089	U1	1 0x1

Value: Value hex: Read receiver

Layers: Flash BBR RAM

Transaction: No transaction

Figure 17: Rover: u-center UBX-CFG-VALSET message view for setting the CFG-MSGGOUT-* configuration items for enabling the output of some recommended UBX messages

UBX - RXM (Receiver Manager) - RTCM (RTCM input status)

Statistics:

Message Type	Total messages	CRC passed messages	CRC failed messages	(Last) Reference Station ID
0	0	0	0	n/a
1002	0	0	0	n/a
1005	33	33	0	0
1009	0	0	0	n/a
1010	0	0	0	n/a
1074	0	0	0	n/a
1077	33	33	0	0
1084	0	0	0	n/a
1087	33	33	0	0
1097	33	33	0	0
1124	0	0	0	n/a
1127	33	33	0	0
1230	33	33	0	0
1001	0	0	0	n/a

* Messages not supported by the receiver

Current messages:

ix	Reference Station ID	Message ID	CRC check
198	0	1005	Passed
197	0	1230	Passed
196	0	1127	Passed
195	0	1097	Passed
194	0	1087	Passed
193	0	1077	Passed
192	0	1005	Passed
191	0	1230	Passed
190	0	1127	Passed
189	0	1097	Passed
188	0	1087	Passed
187	0	1077	Passed
186	0	1005	Passed
185	0	1230	Passed
184	0	1127	Passed

Figure 18: Rover: u-center UBX-RXM-RTCM view

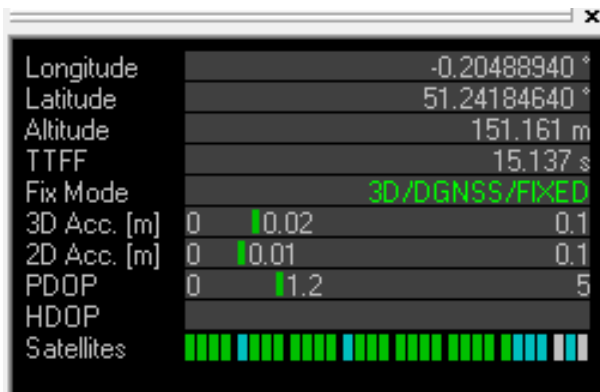

Figure 19: Rover: u-center data view with RTK Fixed

3.5.10 RTK rover mode output in messages

RTK Rover Mode will result in following modified output:

- NMEA-GGA: The quality field will be 4 for RTK fixed and 5 for RTK float (see NMEA Position Fix Flags). The age of differential corrections and base station ID will be set.
- NMEA-GLL, NMEA-VTG: The `posMode` indicator will be D for RTK float and R for RTK fixed (see NMEA Position Fix Flags).
- NMEA-RMC, NMEA-GNS: The `posMode` indicator will be F for RTK float and R for RTK fixed (see NMEA Position Fix Flags).
- UBX-NAV-PVT: The `carrSoln` flag will be set to 1 for RTK float and 2 for RTK fixed.
- UBX-NAV-RELPOSNED: The `diffSoln` and `refPosValid` flags will be set. The `carrSoln` flag will be set to 1 for RTK float and 2 for RTK fixed. In moving baseline rover mode, the `isMoving` flag will be set, and the `refPosMiss` and `refObsMiss` flags will be set for epochs during which extrapolated base position or observations have been used.
- UBX-NAV-SAT: The `diffCorr` flag will be set for satellites with valid RTCM data. The `rtcmCorrUsed`, `prCorrUsed`, and `crCorrUsed` flags will be set for satellites for which the RTCM corrections have been applied.
- UBX-NAV-SIG: For signals to which the RTCM corrections have been applied, the correction source will be set to RTCM3 OSR and the `crUsed`, `prCorrUsed`, and `crCorrUsed` flags will be set.
- UBX-NAV-STATUS: The `diffSoln` flag will be set; the `diffCorr` flag will be set.
- If the baseline exceeds 50km and a message type 1005 or type 1006 is received, a UBX-INF-WARNING will be output, e.g. "WARNING: DGNSS baseline big: 52.7 km"

3.6 Default GNSS configuration

The default GNSS configuration is:

- GPS L1C/A L2C
- GLO L1OF L2OF
- GAL E1B/C E5b
- BDS B1I
- QZSS L1C/A L2C





BDS B2I is also supported but not enabled in the default GNSS configuration.

The configuration settings can be modified using UBX protocol configuration messages. For more information, see the ZED-F9P Interface Description [2].

3.7 Default messages

Interface	Settings
UART1 Output	38400 Baud, 8 bits, no parity bit, 1 stop bit. Configured to transmit NMEA, UBX, RTCM 3x protocols. But only the following NMEA (and no UBX) messages have been activated at start-up: GGA, GLL, GSA, GSV, RMC, VTG, TXT .
UART1 Input	38400 Baud, 8 bits, no parity bit, 1 stop bit. Automatically accepts the following protocols without need of explicit configuration: UBX, NMEA, RTCM 3x.
UART2 Output	38400 Baud, 8 bits, no parity bit, 1 stop bit. No host interface (UBX). Configured by default to allow RTCM 3x as an output protocol. NMEA can also be configured as a protocol.
UART2 Input	38400 Baud, 8 bits, no parity bit, 1 stop bit. No Host interface (UBX). Configured by default to allow RTCM 3x as an input protocol. NMEA can also be configured as an input protocol.
USB Output	Configured to transmit NMEA, UBX, RTCM 3x protocols, but only the following NMEA (and no UBX) messages have been activated at start-up: GGA, GLL, GSA, GSV, RMC, VTG, TXT .
USB Input	Automatically accepts following protocols without need of explicit configuration: UBX, NMEA, RTCM 3x.
DDC	Fully compatible with the I ² C industry standard, available for communication with an external host CPU or u-blox cellular modules, operated in slave mode only. Default messages activated as in UART1. Input/output protocols available as in UART1. Maximum bit rate 400 kb/s.
SPI	Allow communication to a host CPU, operated in slave mode only. Default messages activated as in UART1. Input/output protocols available as in UART1. SPI is not available unless the D_SEL interface is set up accordingly (see D_SEL interface).
TIMEPULSE (1 Hz Nav)	1 pulse per second, synchronized at rising edge, pulse length 100 ms

Table 8: Default messages

-  With firmware version HPG 1.00 it is possible to use UART2 as the RTCM 3x interface. RTCM 3x is the default input and output protocol. NMEA can also be configured as an input or output protocol on UART 2.
-  Refer to the u-blox ZED-F9P Interface Description [2] for information about further settings.
-  If the receiver is configured to output RTCM messages on several ports, they must all have the same RTCM message and message rate configuration otherwise the MSM multiple message bit might not be set properly.
-  The ZED-F9P outputs NMEA 4.1 messages that includes satellite data for all GNSS bands being received. This results in many more NMEA messages being output for each navigation period. Ensure the UART1 baud rate being used is sufficient for the set Navigation rate and the amount of GNSS signals being received.

4 Receiver description

This section describes in additional detail core features of the receiver firmware.

4.1 Receiver configuration

u-blox positioning receivers are fully configurable with UBX protocol messages. The configuration used by the receiver during normal operation is called the "current configuration". The current configuration can be changed during normal operation by sending UBX configuration messages over any I/O port. The receiver can change its current configuration immediately after receiving a configuration message. The receiver will always use the current configuration only.

The current configuration is loaded from permanent configuration hard-coded in the receiver firmware (the defaults) and from non-volatile memory (user configuration) on startup of the receiver. Changes made to the current configuration at run-time will be lost when there is a power cycle, a hardware reset or a (complete) controlled software reset (see Forcing a Receiver Reset).

See the Configuration Interface section for a detailed description of the receiver configuration system, the explanation of the configuration concept and its principles and interfaces.



The configuration interface has changed from earlier u-blox positioning receivers. There is some backwards compatibility. Users are strongly advised to only use the Configuration Interface referred to in the following sections.

4.2 Changing configuration

All configuration messages, including legacy UBX-CFG messages, will result in an ACK or NACK response. If several configuration messages are sent without waiting for this response then the receiver may pause processing of input messages until processing of a previous configuration message has been completed. When this happens a warning message "wait for cfg ACK" will be sent to the host.

4.3 Basic receiver configuration

This section summarizes the basic receiver configuration most commonly used.

4.3.1 Communication interface configuration

Several configuration items allow operation mode configuration of the various communications interfaces. This includes parameters for the data framing, transfer rate and protocols used. See Serial Communication Ports Description for details. The configuration items available for each interface are:

- UART1 interface: CFG-UART1-*, CFG-UART1INPROT-*, CFG-UART1OUTPROT-*
- UART2 interface: CFG-UART2-*, CFG-UART2INPROT-*, CFG-UART2OUTPROT-*
- SPI interface: CFG-SPI-*, CFG-SPIINPROT-*, CFG-SPIOUTPROT-*
- I2C interface: CFG-I2C-*, CFG-I2CINPROT-*, CFG-I2COUTPROT-*
- USB interface: CFG-USB-*, CFG-USBINPROT-*, CFG-USBOUTPROT-*

4.3.2 Message output configuration

The rate of NMEA, UBX and RTCM protocol output messages is configurable. If the rate configuration value is zero, then the corresponding message will not be output. Values greater than zero indicate how often the message is output.

For periodic output messages the rate relates to the event the message is related to. For example, the NAV-PVT (Navigation Position Velocity and Time Solution) is related to the navigation epoch.

If the rate of this message is set to one (1), it will be output for every navigation epoch. If the rate is set to two (2), it will be output every other navigation epoch. The rates of the output messages are individually configurable per communication interface. See the CFG-MSGOUT-* configuration group.

Some messages, such as UBX-MON-VER, are not periodic and will only be output as the answer to a poll request.

The UBX-INF-* information messages are non-periodic output messages that do not have a message rate configuration. Instead they can be enabled for each communication interface via the CFG-INFMSG-* configuration group.



All message output is additionally subject to the protocol configuration of the communication interfaces. Messages of a given protocol will not be output until the protocol is enabled for output on the interface (see previous section).

4.3.3 GNSS signal configuration

Several configuration items govern the use of GNSS signals and constellations. Each GNSS constellation can be controlled separately. Similarly, each signal within the constellation can be handled independently of each other. The constellation enable master keys and their associated signal enable keys are linked such that a GNSS constellation is considered enabled if and only if the master constellation enable key is set and at least one signal associated with that constellation is enabled.

This dependency allows the user to disable a constellation without having to disable each signal on its own. The signal enable keys give users the flexibility to enable or disable each signal separately if they need to. See figure below which describes the flow of enabling / disabling a constellation.

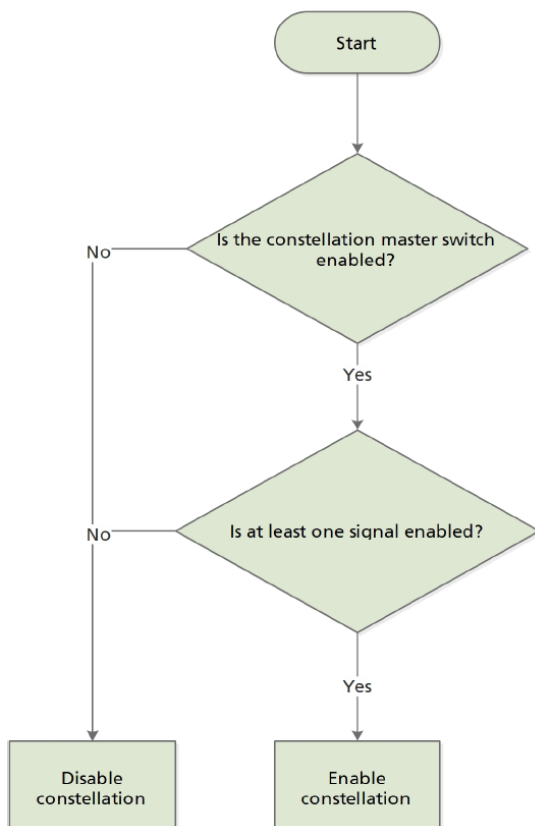

Figure 20: Flow diagram of the individual signal switches and master constellation switches

See the table below for an example of possible combinations of values for configuration items related to GPS signals and whether they mean the constellation is enabled or not.

master switch CFG-SIGNAL-GPS_ENA	signal switch CFG-SIGNAL-GPS_L1CA_ENA	signal switch CFG-SIGNAL-GPS_L2C_ENA	Constellation enabled?
false (0)	false (0)	false (0)	no
false (0)	false (0)	true (1)	no
false (0)	true (1)	false (0)	no
false (0)	true (1)	true (1)	no
true (1)	false (0)	false (0)	no
true (1)	false (0)	true (1)	yes
true (1)	true (1)	false (0)	yes
true (1)	true (1)	true (1)	yes

Table 9: Example of possible values of configuration items for the GPS constellation



On ZED-F9P receivers only some combinations of signals are supported. For all systems, both L1 and L2 signals need to be either enabled or disabled, with the exception of the BeiDou B2 signal, which may be disabled individually. Attempts at configuring unsupported combinations will be rejected by the receiver. The receiver responds to such UBX-CFG-VALSET messages with a UBX-ACK-NAK and, if configured, additionally sends the warning: "invalid sig cfg".

4.3.4 Antenna supervisor configuration

This section describes the antenna supervisor configuration, its use and restrictions.

The antenna supervisor is used to control an active antenna. The configuration of the antenna supervisor allows the following:

- Control voltage supply to the antenna, which allows the antenna supervisor to cut power to the antenna at the event of a short circuit or optimize power to the antenna in Power Save Mode
- Detect a short circuit in the antenna and auto recover the antenna supply in such event
- Detect an open antenna, which can be used to tell if the antenna has been disconnected

See the table below, for a description of the configuration items related to the antenna supervisor operation.

Configuration Item	Description	Comments
CFG-HW-ANT_CFG_VOLTCTRL	Enable active antenna voltage control	
CFG-HW-ANT_CFG_SHORTDET	Enable short circuit detection	
CFG-HW-ANT_CFG_OPENDET	Enable open circuit detection	
CFG-HW-ANT_CFG_PWRDOWN	Power Down Antenna supply if Short Circuit is detected	
CFG-HW-ANT_CFG_RECOVER	Enable auto recovery in the event of a short circuit	To use this feature, short circuit detection should be enabled. See CFG-HW-ANT_CFG_SHORTDET

Table 10: Antenna Supervisor Configuration

It is possible to obtain the status of the antenna supervisor through UBX-MON-RF message. Moreover, any changes in the status of the antenna supervisor are reported to the host interface in the form of notice messages. See the tables below for a description of the antenna state status and the antenna power status.

Status	Description
OFF	Antenna is off
ON	Antenna is on

Status	Description
DONTKNOW	Antenna power status is not known

Table 11: Antenna Power Status

4.4 Legacy configuration interface compatibility

There is interface backwards-compatibility for the legacy UBX-CFG configuration messages, such as the UBX-CFG-NAV5 message. See Legacy UBX-CFG Message Fields Reference section in the ZED-F9P Interface Description [2].

4.5 Serial Communication Ports Description

u-blox receivers come with a highly flexible communication interface. It supports the NMEA and the proprietary UBX protocols, and is truly multi-port and multi-protocol capable. Each protocol (UBX, NMEA) can be assigned to several ports at the same time (multi-port capability) with individual settings (e.g. baud rate, message rates, etc.) for each port. It is even possible to assign more than one protocol (e.g. UBX protocol and NMEA at the same time) to a single port (multi-protocol capability), which is particularly useful for debugging purposes.

Port #	Electrical Interface
0	DDC (I ² C compatible)
1	UART1
2	UART2
3	USB
4	SPI

Table 12: Port Number assignment

The following table shows the port numbers reported in the UBX-MON-COMMS message.

Port #	Electrical Interface
0x0000	DDC (I ² C compatible)
0x0001	UART1
0x0102	UART2
0x0003	USB
0x0004	SPI

Table 13: Port Number assignment

4.5.1 TX-ready indication

This feature enables each port to define a corresponding pin, which indicates if bytes are ready to be transmitted. By default, this feature is disabled. For USB, this feature is configurable but might not behave as described below due to a different internal transmission mechanism. If the number of pending bytes reaches the threshold configured for this port, the corresponding pin will become active (configurable active-low or active-high), and stay active until the last bytes have been transferred from software to hardware (note that this is not necessarily equal to all bytes transmitted, i.e. after the pin has become inactive, up to 16 bytes can still need to be transferred to the host).

The TX-ready pin can be selected from all PIOs which are not in use (see UBX-MON-HW3 for a list of the PIOs and their mapping), each TX-ready pin is exclusively for one port and cannot be shared. If the PIO is invalid or already in use, only the configuration for the TX-ready pin is ignored, the rest of the port configuration is applied if valid. The acknowledge message does not indicate if the TX-ready configuration is successfully set, it only indicates the successful configuration of the port. To validate successful configuration of the TX-ready pin, the port configuration should be polled and the settings of TX-ready feature verified (will be set to disabled/all zero if the settings are invalid).

The threshold should not be set above 2 kB, as the internal message buffer limit can be reached before this, resulting in the TX-ready pin never being set as messages are discarded before the threshold is reached.

4.5.2 Extended TX timeout

If the host does not communicate over SPI or DDC for more than approximately 2 seconds, the device assumes that the host is no longer using this interface and no more packets are scheduled for this port. This mechanism can be changed by enabling "extended TX timeouts", in which case the receiver delays idling the port until the allocated and undelivered bytes for this port reach 4 kB. This feature is especially useful when using the TX-ready feature with a message output rate of less than once per second, and polling data only when data is available, determined by the TX-ready pin becoming active.

4.5.3 UART Ports

One or two Universal Asynchronous Receiver/Transmitter (**UART**) ports are featured, that can be used to transmit GNSS measurements, monitor status information and configure the receiver. See our on-line product descriptions for availability.

The serial ports consist of an RX and a TX line. Neither handshaking signals nor hardware flow control signals are available. These serial ports operate in asynchronous mode. The baud rates can be configured individually for each serial port. However, there is no support for setting different baud rates for reception and transmission.



As of Protocol version 18+, the UART RX interface will be disabled when more than 100 frame errors are detected during a one-second period. This can happen if the wrong baud rate is used or the UART RX pin is grounded. The error message appears when the UART RX interface is re-enabled at the end of the one-second period.

Baud Rate	Data Bits	Parity	Stop Bits
4800	8	none	1
9600	8	none	1
19200	8	none	1
38400	8	none	1
57600	8	none	1
115200	8	none	1
230400	8	none	1
460800	8	none	1
921600	8	none	1

Table 14: Possible UART Interface Configurations

Note that for protocols such as NMEA or UBX, it does not make sense to change the default word length values (data bits) since these properties are defined by the protocol and not by the electrical interface.

If the amount of data configured is too much for a certain port's bandwidth (e.g. all UBX messages output on a UART port with a baud rate of 9600), the buffer will fill up. Once the buffer space is exceeded, new messages to be sent will be dropped. To prevent message losses, the baud rate and communication speed or the number of enabled messages should be selected so that the expected number of bytes can be transmitted in less than one second.

4.5.4 USB Port

One Universal Serial Bus (**USB**) port is featured. See the Data Sheet of your specific product for availability. This port can be used for communication purposes and to power the positioning chip or module.

The USB interface supports one power mode:

- In *Self Powered Mode* the receiver is powered by its own power supply. V_USB is used to detect the availability of the USB port, i.e. whether the receiver is connected to a USB host.



USB Bus powered mode is not supported.



The voltage range for V_USB is specified from 3.0 V to 3.6 V, which differs slightly from the specification for VCC.



The boot screen is retransmitted on the USB port after the enumeration. However, messages generated between boot-up of the receiver and USB enumeration are not visible on the USB port.

4.5.5 DDC Port

The Display Data Channel (DDC) bus is a two-wire communication interface compatible with the I²C standard ([Integrated Circuit](#)). See our on-line product selector matrix for availability.

Unlike all other interfaces, the DDC is not able to communicate in full-duplex mode, i.e. TX and RX are mutually exclusive. u-blox receivers act as a slave in the communication setup, therefore they cannot initiate data transfers on their own. The host, which is always master, provides the data clock (SCL), and the clock frequency is therefore not configurable on the slave.

The receiver's DDC address is set to 0x42 by default.

As the receiver will be run in slave mode and the DDC physical layer lacks a handshake mechanism to inform the master about data availability, a layer has been inserted between the physical layer and the UBX and NMEA layer. The receiver DDC interface implements a simple streaming interface that allows the constant polling of data, discarding everything that is not parse-able. The receiver returns 0xFF if no data is available. The TX-ready feature can be used to inform the master about data availability and can be used as a trigger for data transmission.

4.5.5.1 Read Access

The DDC interface allows 256 slave registers to be addressed. As shown in Figure *DDC Register Layout* only three of these are currently implemented. The data registers 0 to 252, at addresses 0x00 to 0xFC, each 1 byte in size, contain information to be defined later - the result of reading them is undefined. The currently available number of bytes in the message stream can be read at addresses 0xFD and 0xFE. The register at address 0xFF allows the data stream to be read. If there is no data awaiting transmission from the receiver, then this register will deliver the value 0xff, which cannot be the first byte of a valid message. If message data is ready for transmission, then successive reads of register 0xff will deliver the waiting message data.



The registers 0x00 to 0xFC are reserved for future use and may be defined in a later firmware release. Do not use them, as they don't provide any meaningful data!

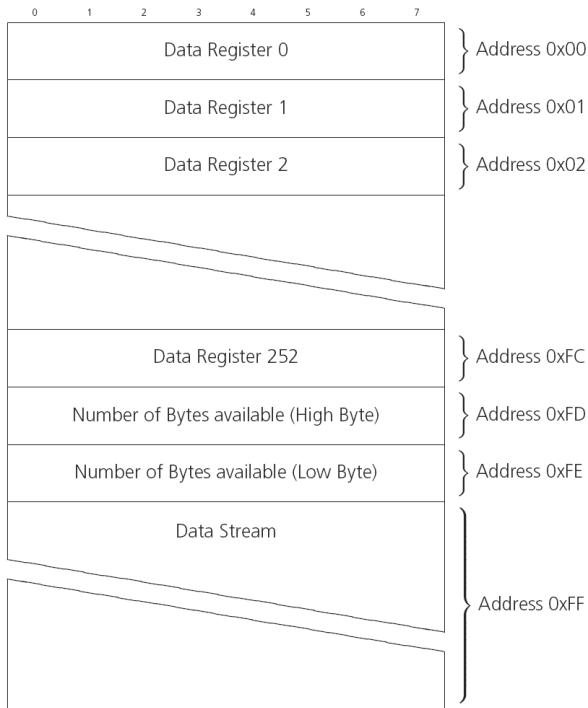

Figure 21: DDC Register Layout

4.5.5.1.1 Read Access Forms

There are two forms of DDC read transfer. The "random access" form includes a slave register address and thus allows any register to be read. The second "current address" form omits the register address. If this second form is used, then an address pointer in the receiver is used to determine which register to read. This address pointer will increment after each read unless it is already pointing at register 0xff, the highest addressable register, in which case it remains unaltered. The initial value of this address pointer at start-up is 0xff, so by default all current address reads will repeatedly read register 0xff and receive the next byte of message data (or 0xff if no message data is waiting). Figure *DDC Random Read Access* shows the format of the random access form of the request. Following the start condition from the master, the 7-bit device address and the RW bit (which is a logic low for write access) are clocked onto the bus by the master transmitter. The receiver answers with an acknowledge (logic low) to indicate that it recognizes the address. Next, the 8-bit address of the register to be read must be written to the bus. Following the receivers acknowledge, the master again triggers a start condition and writes the device address, but this time the RW bit is a logic high to initiate the read access. Now, the master can read 1 to N bytes from the receiver, generating a not-acknowledge and a stop condition after the last byte being read.

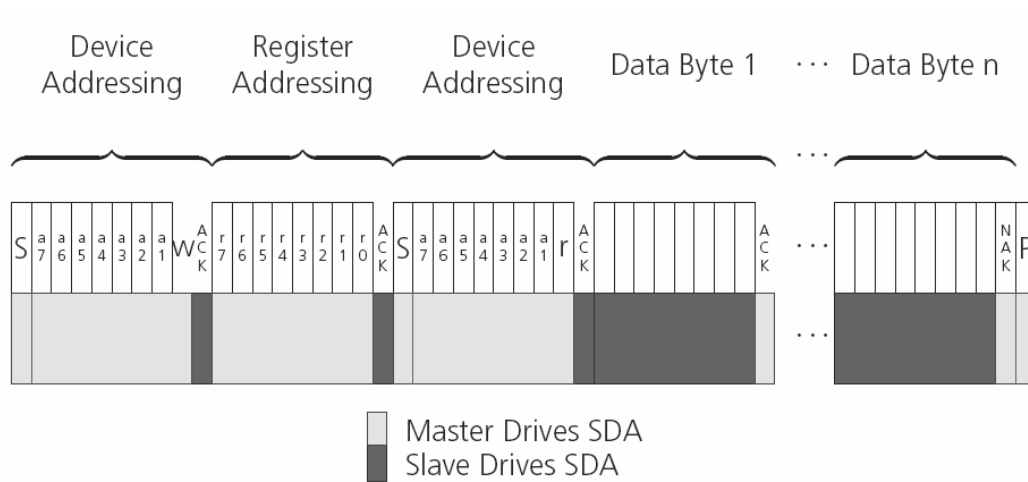

Figure 22: DDC Random Read Access

The format of the current address read request is :

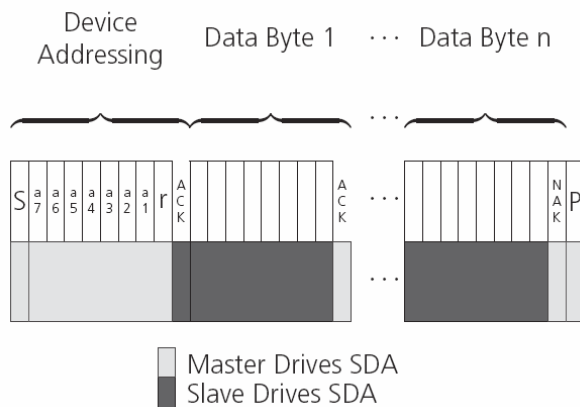

Figure 23: DDC Current Address Read Access

4.5.5.2 Write Access

The receiver does not provide any write access except for writing UBX and NMEA messages to the receiver, such as configuration or aiding data. Therefore, the register set mentioned in section Read Access is not writeable. Following the start condition from the master, the 7-bit device address and the \overline{RW} bit (which is a logic low for write access) are clocked onto the bus by the master transmitter. The receiver answers with an acknowledge (logic low) to indicate that it is responsible for the given address. Now, the master can write 2 to N bytes to the receiver, generating a stop condition after the last byte being written. The number of data bytes must be at least 2 to properly distinguish from the write access to set the address counter in random read accesses.

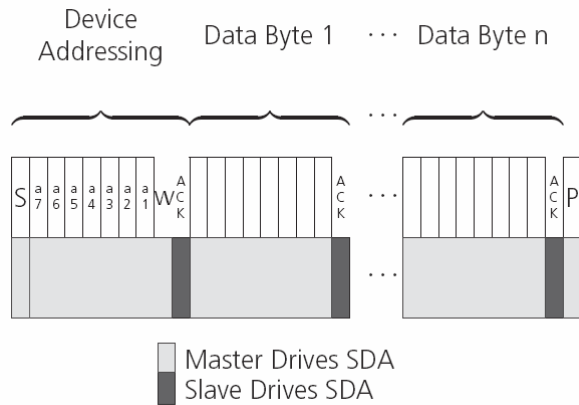

Figure 24: DDC Write Access

4.5.6 SPI Port

A Serial Peripheral Interface (SPI) bus is available with selected receivers. See our on line product descriptions for availability.

SPI is a four-wire synchronous communication interface. In contrast to UART, the master provides the clock signal, which therefore doesn't need to be specified for the slave in advance. Moreover, a baud rate setting is not applicable for the slave.



CAUTION The SPI clock speed is limited depending on hardware and firmware versions!

4.5.6.1 Maximum SPI clock speed

The receiver supports a maximum SPI clock speed of 5.5 MHz.

4.5.6.2 Read Access

As the register mode is not implemented for the SPI port, only the UBX/NMEA message stream is provided. This stream is accessed using the Back-To-Back Read and Write Access (see section Back-To-Back Read and Write Access). When no data is available to be written to the receiver, *MOSI* should be held logic high, i.e. all bytes written to the receiver are set to 0xFF.

To prevent the receiver from being busy parsing incoming data, the parsing process is stopped after 50 subsequent bytes containing 0xFF. The parsing process is re-enabled with the first byte not equal to 0xFF.

If the receiver has no more data to send, it sets *MISO* to logic high, i.e. all bytes transmitted decode to 0xFF. An efficient parser in the host will ignore all 0xFF bytes which are not part of a message and will resume data processing as soon as the first byte not equal to 0xFF is received.

4.5.6.3 Back-To-Back Read and Write Access

The receiver does not provide any write access except for writing UBX and NMEA messages to the receiver, such as configuration or aiding data. For every byte written to the receiver, a byte will simultaneously be read from the receiver. While the master writes to *MOSI*, at the same time it needs to read from *MISO*, as any pending data will be output by the receiver with this access. The data on *MISO* represents the results from a current address read, returning 0xFF when no more data is available.

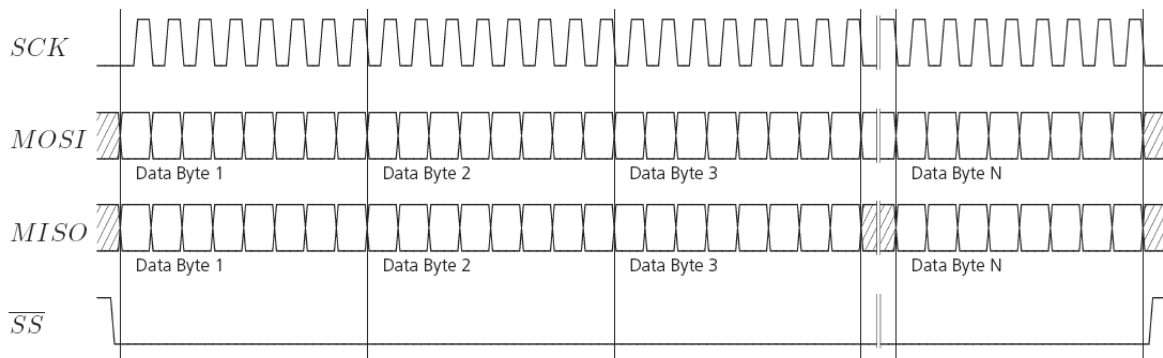

Figure 25: SPI Back-To-Back Read/Write Access

4.6 Multiple GNSS Assistance (MGA)

The u-blox MGA services provide a proprietary implementation of an A-GNSS protocol compatible with u-blox GNSS receivers. When a client device makes an MGA assistance request, the service responds with the requested data using UBX protocol messages. These messages are ready for direct transmission to the receiver communication port without requiring any modification by the client. Currently, these MGA services consist of AssistNow Online and Offline, each delivered by the HTTP or HTTPS protocols. AssistNow Online optionally provides satellite ephemerides, health information and time aiding data suitable for GNSS receiver systems with direct internet access. The AssistNow Offline service benefits u-blox GNSS receivers that only have occasional internet access. Users request data from the service by specifying the time period for which they want coverage (1 to 5 weeks). The data downloaded from the service is organized by date and encoded into a sequence of UBX MGA messages.

The ZED-F9P supports AssistNow Online.

4.6.1 AssistNow Online

AssistNow Online is u-blox' end-to-end Assisted GNSS (A-GNSS) solution for receivers that have access to the Internet. Data supplied by the AssistNow Online Service can be directly uploaded to a u-blox receiver in order to substantially reduce Time To First Fix (TTFF), even under poor signal conditions. The system works by collecting data such as ephemeris and almanac from the satellites through u-blox' Global Reference Network of receivers and providing this data to customers in a convenient form that can be forwarded on directly to u-blox receivers.

The AssistNow Online Service uses a simple, stateless, HTTP interface. Therefore, it works on all standard mobile communication networks that support Internet access, including GPRS, UMTS and Wireless LAN. No special arrangements need to be made with mobile network operators to enable AssistNow Online.

Multiple GNSS Assistance Architecture

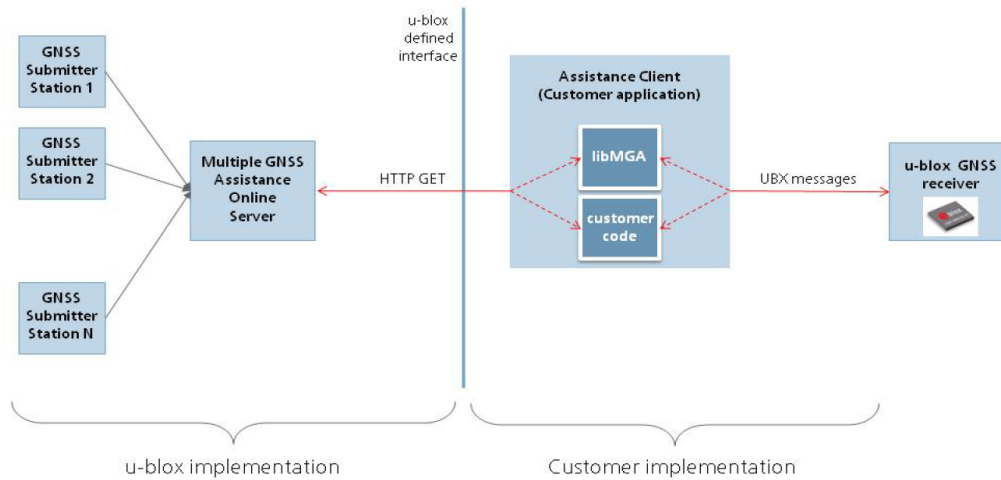

Figure 26: MGA architecture

The data returned by the AssistNow Online Service is a sequence of UBX-MGA messages, starting with an estimate of the current time in the form of a UBX-MGA-INITIME_UTC message.



AssistNow Online currently supports GPS, GLONASS, BeiDou, Galileo, and QZSS.



Customers may choose to use third party sources of assistance data instead of using the AssistNow Online Service. Customers choosing this option will need to ensure that the data is converted from the format used by the third party source to the appropriate MGA messages. However, it is important to ensure that the receiver has an estimate of the current time before it processes any other assistance data. For this reason, it is strongly recommended to send a UBX-MGA-INITIME_UTC or UBX-MGA-INITIME_GNSS as the first message of any assistance.

4.6.2 Host software

As u-blox receivers have no means to connect directly with the Internet, the AssistNow Online system can only work if the host system that contains the receiver can connect to the Internet, download the data from the AssistNow Online Service and forward it on to the receiver. In the simplest case that may involve fetching the data from the AssistNow Online Service (by means of a single HTTP GET request), and sending the resulting data to the receiver.

Depending on the circumstances, it may be beneficial for the host software to include:

- Creating an appropriate UBX-MGA-INITIME_UTC message to deliver a better sense of time to the receiver, especially if the host system has a very good sense of the current time and can deliver a time pulse to one of the receiver's EXTINT pins.
- Enable and use flow control to prevent loss of data due to buffer overflow in the receiver.



u-blox provides the source code for an example library, called libMGA, that provides all of the functionality we expect in most host software.

4.6.3 AssistNow Online sequence

A typical sequence of use of the AssistNow Online Service comprises the following steps:

- Power-up the u-blox receiver
- Request data from the AssistNow Online Service

- Optionally send UBX-MGA-INI-TIME_UTC followed by hardware time synchronization pulse if hardware time synchronization is required.
- Send the UBX messages obtained from the AssistNow Online Service to the receiver.

4.6.4 Flow control

u-blox receivers aim to process incoming messages as quickly as possible, but there will always be a small delay in processing each message. Uploading assistance data to the receiver can involve sending as many as one hundred of individual messages to the receiver, one after the other. If the communication link is fast, and/or the receiver is busy (trying to acquire new signals), it is possible that the internal buffers will overflow and some messages will be lost. In order to combat this, u-blox receivers support an optional flow control mechanism for assistance.

Flow control is activated by using the CFG-NAVSPG-ACKAIDING configuration item. As a result the receiver will issue an acknowledgment message (ACK) for each assistance message it successfully receives. The host software can examine these acknowledgments to establish whether there were any problems with the data sent to the receiver and deduce (by the lack of acknowledgment) if any messages have been lost. It may then be appropriate to resend some of the assistance messages.

The simplest way to implement flow control would be to send one UBX-MGA assistance message at a time, waiting for the acknowledgment, before sending the next. However, such a strategy is likely to introduce significant delays into the whole assistance process. The best strategy will depend on the amount of assistance data being sent and the nature of the communications link (e.g. baud rate of serial link). u-blox recommends that when customers are developing their host software they start by sending all assistance messages and then analyze the resulting acknowledgments to see if there are any losses of messages. Adding small delays during the transmission may be a simple but effective way to avoid loss of data.

4.6.5 Authorization

The AssistNow Online Service is only available for use by u-blox customers. In order to use the services, customers will need to obtain an authorization token from u-blox. This token must be supplied as a parameter whenever a request is made to either service.

4.6.6 Service parameters

The information exchange with the AssistNow Online Service is based on the HTTP protocol. Upon reception of an HTTP GET request, the server will respond with the required messages in binary format or with an error string in text format. After delivery of all data, the server will terminate the connection.

The HTTP GET request from the client to the server should contain a standard HTTP query string in the request URL. The query string consists of a set of "key=value" parameters in the following form:

key=value;key=value;key=value;

The following rules apply:

- The order of keys is important
- Keys and values are case sensitive
- Keys and values must be separated by an "equal" character ("=").
- Key/value pairs must be separated by semicolons (";").
- If a value contains a list, each item in the list must be separated by a comma (",").

The following table describes the keys that are supported:

Key Name	Unit/ Range	Optional	Description
token	String	Mandatory	The authorization token supplied by u-blox when a client registers to use the service.

Key Name	Unit/Range	Optional	Description
gnss	String	Mandatory	A comma separated list of the GNSS for which data should be returned. Valid GNSS are: gps, qzss and glo.
datatype	String	Mandatory	A comma separated list of the data types required by the client. Valid data types are: eph, alm, aux and pos. Time data is always returned for each request. If the value of this parameter is an empty string, only time data will be returned.
lat	Numeric [degrees]	Optional	Approximate user latitude in WGS 84 expressed in degrees and fractional degrees. Must be in range -90 to 90. Example: lat=47.2.
lon	Numeric [degrees]	Optional	Approximate user longitude in WGS 84 expressed in degrees and fractional degrees. Must be in range -180 to 180. Example: lon=8.55.
alt	Numeric [meters]	Optional	Approximate user altitude above WGS 84 Ellipsoid. If this value is not provided, the server assumes an altitude of 0 meters. Must be in range -1000 to 50000.
pacc	Numeric [meters]	Optional	Approximate accuracy of submitted position (see position parameters note below). If this value is not provided, the server assumes an accuracy of 300km. Must be in range 0 to 6000000.
tacc	Numeric [seconds]	Optional	The timing accuracy (see time parameters note below). If this value is not provided, the server assumes an accuracy of 10 seconds. Must be in range 0 to 3600.
latency	Numeric [seconds]	Optional	Typical latency between the time the server receives the request, and the time when the assistance data arrives at the u-blox receiver. The server can use this value to correct the time being transmitted to the client. If this value is not provided, the server assumes a latency of 0. Must be in range 0 to 3600.
filteronpos	(no value required)	Optional	If present, the ephemeris data returned to the client will only contain data for the satellites which are likely to be visible from the approximate position provided by the lat, lon, alt and pacc parameters. If the lat and lon parameters are not provided the service will return an error.
filteronsv	String	Optional	A comma separated list of u-blox gnssId:svId pairs. The ephemeris data returned to the client will only contain data for the listed satellites.

Table 15: AssistNow Online Parameter Keys

Thus, as an example, a valid parameter string would be:

token=XXXXXXXXXXXXXXXXXXXXXXXXXX;gnss=gps,qzss;datatype=eph,pos,aux;lat=47.28;lon=8.56;pacc=1000

4.6.6.1 Position parameters (lat, lon, alt and pacc)

The position parameters (lat, lon, alt and pacc) are used by the server for two purposes:

- If the filteronpos parameter is provided, the server determines the currently visible satellites at the user position, and only sends the ephemeris data of those satellites which should be in view at the location of the user. This reduces bandwidth requirements. In this case the "pacc" value is taken into account, meaning that the server will return all SVs visible in the given uncertainty region.
- If the datatype "pos" is requested, the server will return the position and accuracy in the response data. When this data is supplied to the u-blox receiver, depending on the accuracy of the provided data, the receiver can then choose to select a better startup strategy. For example, if the position is accurate to 100km or better, the u-blox receiver will choose to go for a more optimistic startup strategy. This will result in quicker startup time. The receiver will decide which strategy to choose, depending on the "pacc" parameter. If the submitted user position is less accurate than what is being specified with the "pacc" parameter, then the user will experience prolonged or even failed startups.

4.6.6.2 Time parameters (tacc and latency)

Time data is always returned with each request. The time data refers to the time at which the response leaves the server, corrected by an optional latency value. This time data provided by the service is accurate to approximately 10ms but by default the time accuracy is indicated to be +/-10

seconds in order to account for network latency and any time between the client receiving the data and it being provided to the receiver.

If both the network latency and the client latency can safely be assumed to be very low (or are known), the client can choose to set the accuracy of the time message (tacc) to a much smaller value (e.g. 0.5s). This will result in a faster TTFF. The latency can also be adjusted as appropriate. However, these fields should be used with caution: if the time accuracy is not correct when the time data reaches the receiver, the receiver may experience prolonged or even failed start-ups.

For optimal results, the client should establish an accurate sense of time itself (e.g. by calibrating its system clock using a local NTP service) and then modify the time data received from the service as appropriate.

4.6.7 Multiple servers

u-blox has designed and implemented the AssistNow Online Service in a way that should provide very high reliability. Nonetheless, there will be rare occasions when a server is not available (e.g. due to failure or some form of maintenance activity). In order to protect customers against the impact of such outages, u-blox will run at least two instances of the AssistNow Online Service on independent machines. Customers will have a free choice of requesting assistance data from any of these servers, as all will provide the same information. However, should one fail for whatever reason, it is highly unlikely that the other server(s) will also be unavailable. Therefore customers requiring the best possible availability are recommended to implement a scheme where they direct their requests to a chosen server, but, if that server fails to respond, have a fall-back mechanism to use another server instead.

4.7 Broadcast navigation data

This section describes the data reported via UBX-RXM-SFRBX.

The UBX-RXM-SFRBX reports the broadcast navigation data message collected by the receiver from each tracked signal. When enabled, a separate message is generated every time the receiver decodes a complete subframe of data from a tracked signal. The data bits are reported, as received, including preambles and error checking bits as appropriate. However because there is considerable variation in the data structure of the different GNSS signals, the form of the reported data also varies. Indeed, although this document uses the term "subframe" generically, it is not strictly the correct term for all GNSS (e.g. GLONASS has "strings" and Galileo has "pages").

4.7.1 Parsing navigation data subframes

Each UBX-RXM-SFRBX message contains a subframe of data bits appropriate for the relevant GNSS, delivered in a number of 32 bit words, as indicated by numWords field.

Due to the variation in data structure between different GNSS, the most important step in parsing a UBX-RXMSFRBX message is to identify the form of the data. This should be done by reading the gnssId field, which indicates which GNSS the data was decoded from. In almost all cases, this is sufficient to indicate the structure and the following sections are organized by GNSS for that reason. However, in some cases the identity of the GNSS is not sufficient, and this is described, where appropriate, in the following sections.

In most cases, the data does not map perfectly into a number of 32 bit words and, consequently, some of the words reported in UBX-RXM-SFRBX messages contain fields marked as "Pad". These fields should be ignored and no assumption should be made about their contents.

UBX-RXM-SFRBX messages are only generated when complete subframes are detected by the receiver and all appropriate parity checks have passed.

Where the parity checking algorithm requires data to be inverted before it is decoded (e.g. GPS L1C/A), the receiver carries this out before the message output. Therefore, users can process data directly and do not need to worry about repeating any parity processing.

The meaning of the content of each subframe depends on the sending GNSS and is described in the relevant Interface Control Documents (ICD).

4.7.2 GPS

The data structure in the GPS L1C/A and L2C signals is dissimilar and thus the UBX-RXM-SFRBX message structure differs as well. For the GPS L1C/A and L2C signals it is as follows:

4.7.2.1 GPS L1C/A

For GPS L1C/A signals, there is a fairly straightforward mapping between the reported subframe and the structure of subframe and words described in the GPS ICD. Each subframe comprises ten data words, which are reported in the same order they are received.

Each word is arranged as follows:

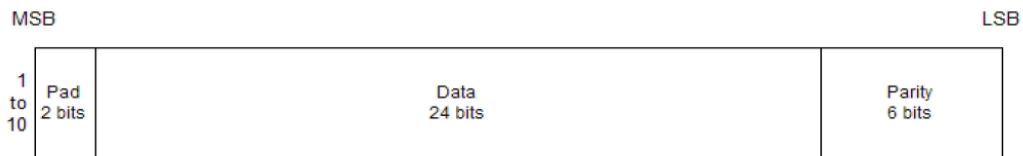

Figure 27: GPS L1C/A subframe word

4.7.2.2 GPS L2C

For GPS L2C signals each reported subframe contains the CNAV message as described in the GPS ICD. The ten words are arranged as follows:

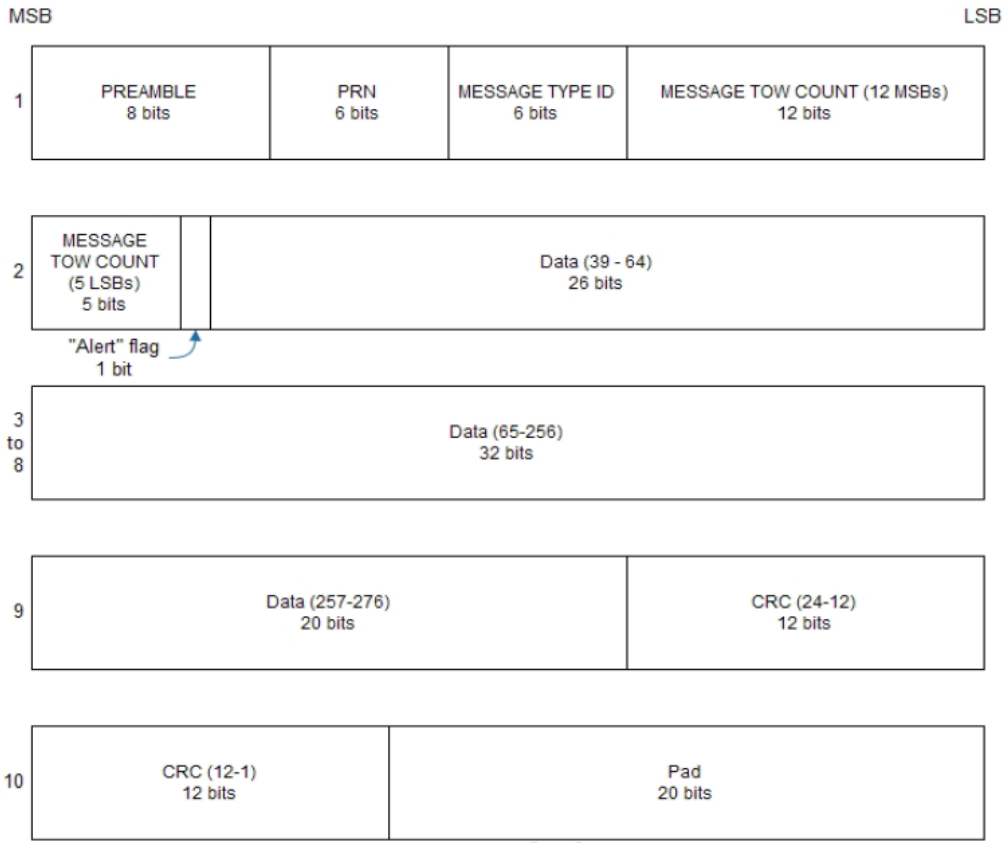

Figure 28: GPS L2C subframe words

4.7.3 GLONASS

For GLONASS L1OF and L2OF signals, each reported subframe contains a string as described in the GLONASS ICD. This string comprises 85 data bits which are reported over three 32 bit words in the UBX-RXM-SFRBX message. Data bits 1 to 8 are always a hamming code, whilst bits 81 to 84 are a string number and bit 85 is the idle chip, which should always have a value of zero. The meaning of other bits vary with string and frame number.

The fourth and final 32 bit word in the UBX-RXM-SFRBX message contains frame and superframe numbers (where available). These values aren't actually transmitted by the SVs, but are deduced by the receiver and are included to aid decoding of the transmitted data. However, the receiver does not always know these values, in which case a value of zero is reported.

The four words are arranged as follows:

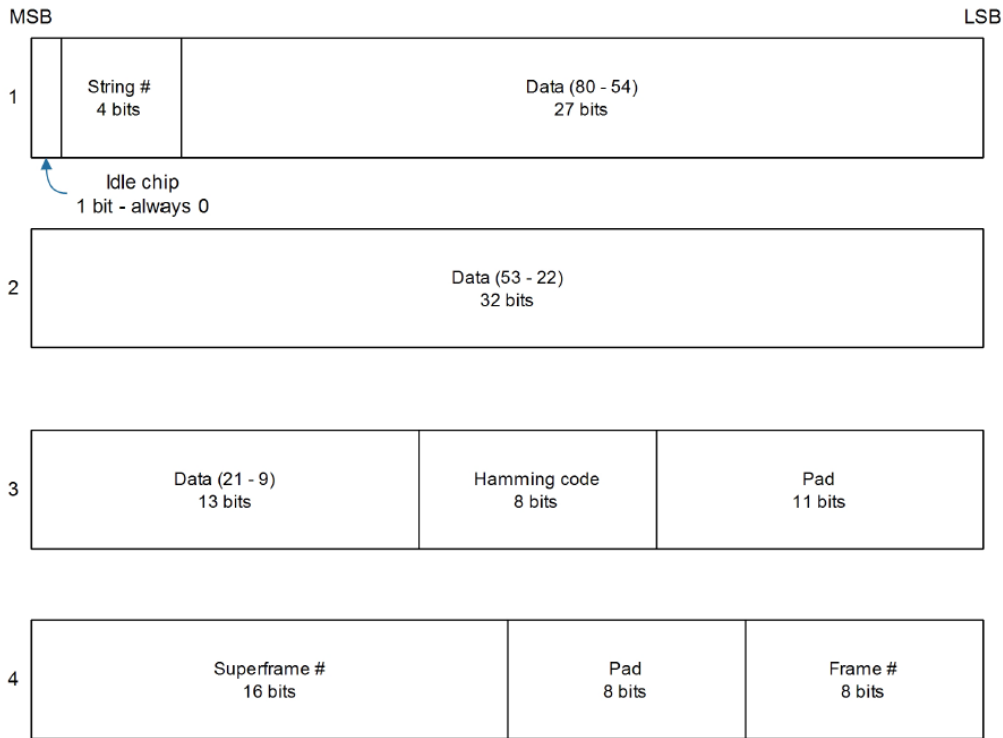

Figure 29: Glonass subframe words

In some circumstances, (especially on startup) the receiver may be able to decode data from a GLONASS SV before it can identify the SV. When this occurs UBX-RXM-SFRBX messages will be issued with an svld of 255 to indicate "unknown".

4.7.4 BeiDou

For BeiDou B1I D1, B1I D2, B2I D1, B2I D2 signals, there is a fairly straightforward mapping between the reported subframe and the structure of subframe and words described in the BeiDou ICD. Each subframe comprises ten data words, which are reported in the same order they are received.

Each word is arranged as follows:

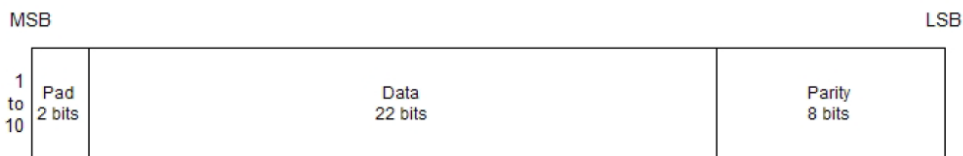

Figure 30: BeiDou subframe word

Note that as the BeiDou data words only comprise 30 bits, the 2 most significant bits in each word reported by UBX-RXM-SFRBX are padding and should be ignored.

4.7.5 Galileo

The Galileo E1 C/B and E5 bl/bQ signals both transmit the I/NAV message but in different configurations. The UBX-RXM-SFRBX structures for them are as follows.

4.7.5.1 Galileo E1 C/B

For Galileo E1 C/B signals, each reported subframe contains a pair of I/NAV pages as described in the Galileo ICD.

Galileo pages can either be "Nominal" or "Alert" pages. For Nominal pages the eight words are arranged as follows:

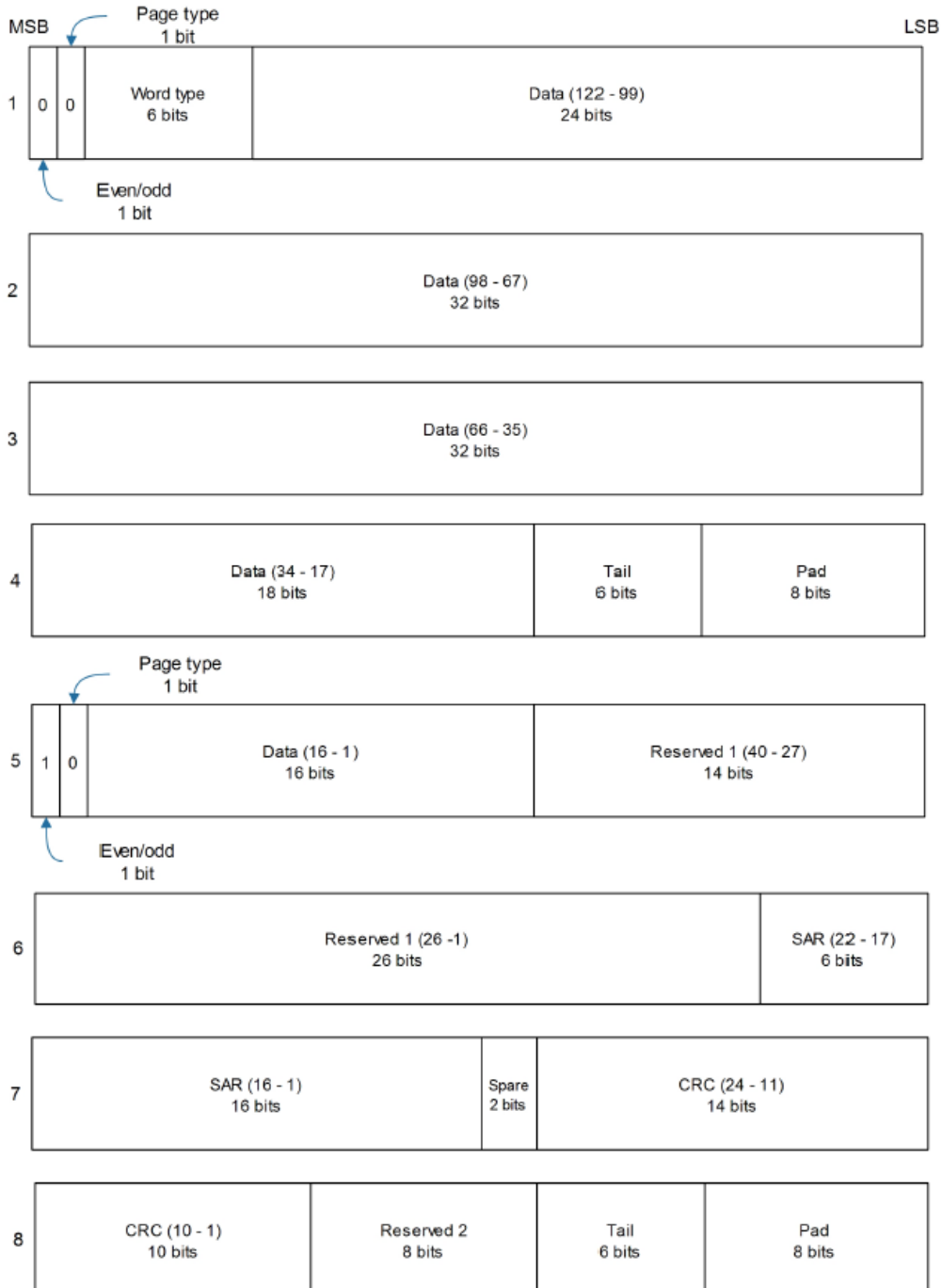

Figure 31: Galileo E1 C/B subframe words

4.7.5.2 Galileo E5 b1/bQ

For Galileo E5 b1/bQ signals, each reported subframe contains a pair of I/NAV pages as described in the Galileo ICD. Galileo pages can either be "Nominal" or "Alert" pages. For Nominal pages the eight words are arranged as follows:

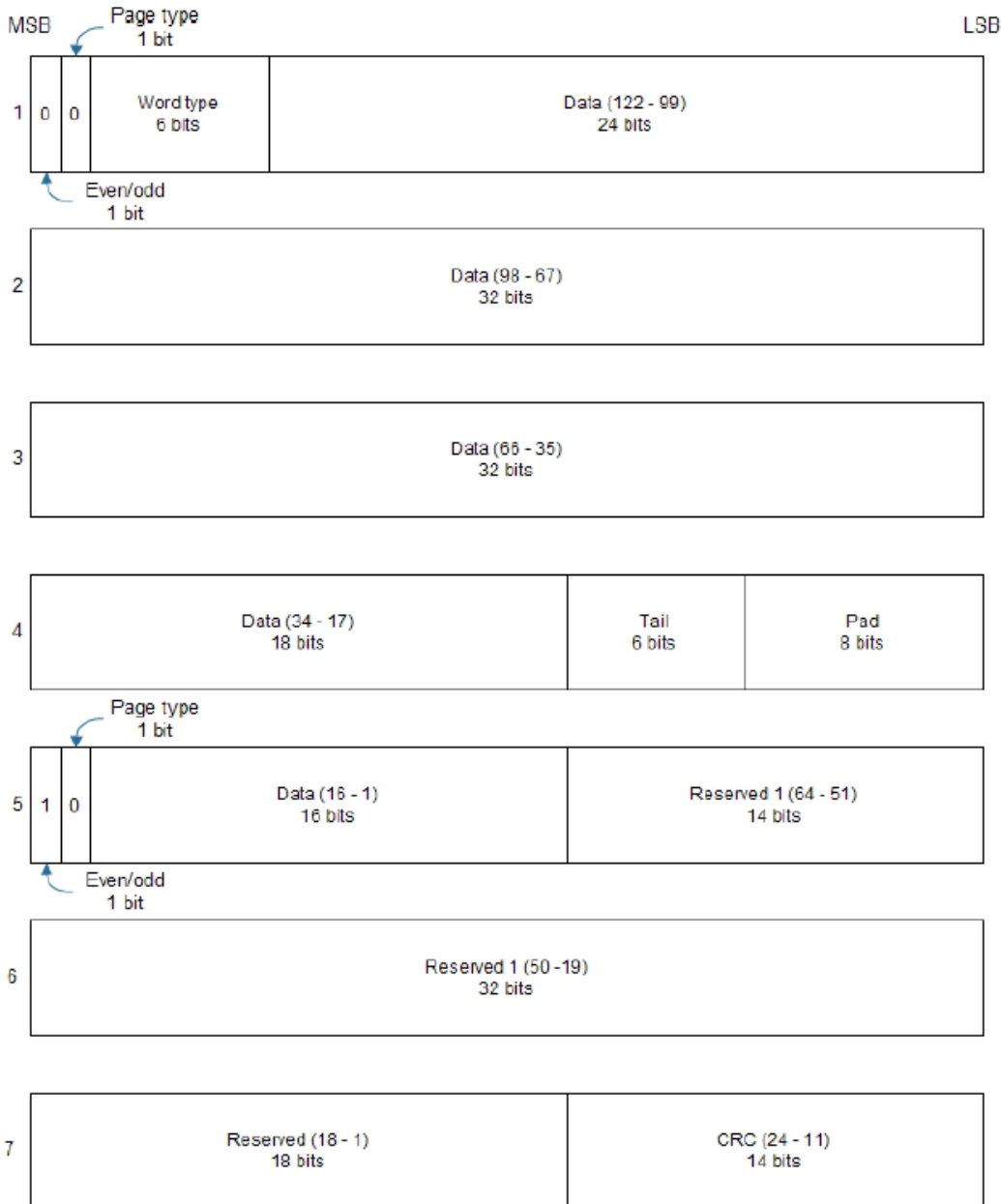

Figure 32: Galileo E5 b1/bQ subframe words

Alert pages are reported in very similar manner, but the page type bits will have value 1 and the structure of the eight words will be slightly different (as indicated by the Galileo ICD).

4.7.6 QZSS

The structure of the data delivered by QZSS L1C/A signals is effectively identical to that for GPS (L1C/A).

Similarly the QZSS L2C signal is effectively identical to the GPS (L2C).

4.7.7 Summary

The following table gives a summary of the different data message formats reported by the UBXRXM-SFRBX message:

GNSS	Signal	gnssId	sigId	numWords	period
GPS	L1C/A	0	0	10	6s
GPS	L2CL	0	3	10	12s
GPS	L2CM	0	4	10	12s
Galileo	E1 C	2	0	8	2s
Galileo	E1 B	2	1	8	2s
Galileo	E5 bl	2	5	8	2s
Galileo	E5 bQ	2	6	8	2s
BeiDou	B1I D1	3	0	10	6s
BeiDou	B1I D2	3	1	10	0.6s
BeiDou	B2I D1	3	2	10	0.6s
BeiDou	B2I D2	3	3	10	0.6s
QZSS	L1C/A	5	0	10	6s
QZSS	L2CM	5	4	10	12s
QZSS	L2CL	5	5	10	12s
GLONASS	L1OF	6	0	4	2s
GLONASS	L2OF	6	2	4	2s

Table 16: Data message formats reported by UBXRXM-SFRBX

4.8 Clocks and time

This section introduces and explains the concepts of receiver clocks and time bases.

4.8.1 Receiver local time

The receiver is dependent on a local oscillator (normally a TCXO) for both the operation of its radio parts and also for timing within its signal processing. No matter what nominal frequency the local oscillator has, u-blox receivers subdivide the oscillator signal to provide a 1 kHz reference clock signal, which is used to drive many of the receiver's processes. In particular, the measurement of satellite signals is arranged to be synchronized with the "ticking" of this 1 kHz clock signal.

When the receiver first starts, it has no information about how these clock ticks relate to other time systems; it can only count time in 1 millisecond steps. However, as the receiver derives information from the satellites it is tracking or from aiding messages, it estimates the time that each 1 kHz clock tick takes in the time-base of the relevant GNSS system. In previous generations of u-blox receivers this was always the GPS time-base, but for this generation it could be GPS, GLONASS, Galileo, or BeiDou. This estimate of GNSS time based on the local 1 kHz clock is called receiver local time.

As receiver local time is a mapping of the local 1 kHz reference onto a GNSS time-base, it may experience occasional discontinuities, especially when the receiver first starts up and the information it has about the time-base is changing. Indeed after a cold start receiver local time will initially indicate the length of time that the receiver has been running. However, when the receiver obtains some credible timing information from a satellite or aiding message, it will jump to an estimate of GNSS time.

4.8.2 Navigation epochs

Each navigation solution is triggered by the tick of the 1 kHz clock nearest to the desired navigation solution time. This tick is referred to as a navigation epoch. If the navigation solution attempt is

successful, one of the results is an accurate measurement of time in the time-base of the chosen GNSS system, called GNSS system time. The difference between the calculated GNSS system time and receiver local time is called the clock bias (and the clock drift is the rate at which this bias is changing).

In practice the receiver's local oscillator will not be as stable as the atomic clocks to which GNSS systems are referenced and consequently clock bias will tend to accumulate. However, when selecting the next navigation epoch, the receiver will always try to use the 1 kHz clock tick which it estimates to be closest to the desired fix period as measured in GNSS system time. Consequently the number of 1 kHz clock ticks between fixes will occasionally vary (so when producing one fix per second, there will normally be 1000 clock ticks between fixes, but sometimes, to correct drift away from GNSS system time, there will be 999 or 1001).

The GNSS system time calculated in the navigation solution is always converted to a time in both the GPS and UTC time-bases for output.

Clearly when the receiver has chosen to use the GPS time-base for its GNSS system time, conversion to GPS time requires no work at all, but conversion to UTC requires knowledge of the number of leap seconds since GPS time started (and other minor correction terms). The relevant GPS to UTC conversion parameters are transmitted periodically (every 12.5 minutes) by GPS satellites, but can also be supplied to the receiver via the UBX-MGA-GPS-UTC aiding message. By contrast when the receiver has chosen to use the GLONASS time-base as its GNSS system time, conversion to GPS time is more difficult as it requires knowledge of the difference between the two time-bases, but conversion to UTC is easier (as GLONASS time is closely linked to UTC).

Where insufficient information is available for the receiver to perform any of these time-base conversions precisely, pre-defined default offsets are used. Consequently plausible times are nearly always generated, but they may be wrong by a few seconds (especially shortly after receiver start). Depending on the configuration of the receiver, such "invalid" times may well be output, but with flags indicating their state (e.g. the "valid" flags in UBX-NAV-PVT).



u-blox receivers employ multiple GNSS system times and/or receiver local times (in order to support multiple GNSS systems concurrently), so users should not rely on UBX messages that report GNSS system time or receiver local time being supported in future. It is therefore recommended to give preference to those messages that report UTC time.

4.8.3 iTOW timestamps

All the main UBX-NAV messages (and some other messages) contain an iTOW field which indicates the GPS time at which the navigation epoch occurred. Messages with the same iTOW value can be assumed to have come from the same navigation solution.

Note that iTOW values may not be valid (i.e. they may have been generated with insufficient conversion data) and therefore it is not recommended to use the iTOW field for any other purpose.



The original designers of GPS chose to express time/date as an integer week number (starting with the first full week in January 1980) and a time of week (often abbreviated to TOW) expressed in seconds. Manipulating time/date in this form is far easier for digital systems than the more "conventional" year/month/day, hour/minute/second representation. Consequently, most GNSS receivers use this representation internally, only converting to a more "conventional form" at external interfaces. The iTOW field is the most obvious externally visible consequence of this internal representation.

If reliable absolute time information is required, users are recommended to use the UBX-NAV-PVT navigation solution message which also contains additional fields that indicate the validity (and accuracy in UBX-NAV-PVT) of the calculated times (see also the GNSS Times section below for further messages containing time information).

4.8.4 GNSS times

Each GNSS has its own time reference for which detailed and reliable information is provided in the messages listed in the table below.

Time Reference	Message
GPS Time	UBX-NAV-TIMEGPS
BeiDou Time	UBX-NAV-TIMEBDS
GLONASS Time	UBX-NAV-TIMEGLO
Galileo Time	UBX-NAV-TIMEGAL
UTC Time	UBX-NAV-TIMEUTC

Table 17: GNSS Times

4.8.5 Time validity

Information about the validity of the time solution is given in the following form:

- **Time validity:** Information about time validity is provided in the `valid` flags (e.g. `validDate` and `validTime` flags in the UBX-NAV-PVT message). If these flags are set, the time is known and considered as valid for being used. These flags can be found in the GNSS Times table in the GNSS Times section above as well as in the UBX-NAV-PVT message.
- **Time validity confirmation:** Information about confirmed validity is provided in the `confirmedDate` and `confirmedTime` flags in the UBX-NAV-PVT message. If these flags are set, the time validity could be confirmed by using an additional independent source, meaning that the probability of the time to be correct is very high. Note that information about time validity confirmation is only available if the `confirmedAvai` bit in the UBX-NAV-PVT message is set.



`validDate` means that the receiver has knowledge of the current date. However, it must be noted that this date of the date might be wrong for various reasons. Only when the `confirmedDate` flag is set, the probability of the bad date information drops significantly.



`validTime` means that the receiver has knowledge of the current time. However, it must be noted that this time might be wrong for various reasons. Only when the `confirmedTime` flag is set, the probability of bad time information drops significantly.



`fullyResolved` means that the UTC time is known without full seconds ambiguity. When deriving UTC time from GNSS time the number of leap seconds must be known, with the exception of GLONASS. It might take several minutes to obtain such information from the GNSS payload. When the one second ambiguity has not been resolved, the time accuracy is usually in the range of ~20s.

4.8.6 UTC representation

UTC time is used in many NMEA and UBX messages. In NMEA messages it is always reported rounded to the nearest hundredth of a second. Consequently, it is normally reported with two decimal places (e.g. 124923.52). What is more, although compatibility mode (selected using CFG-NMEA-COMPAT) requires three decimal places, rounding to the nearest hundredth of a second remains, so the extra digit is always 0.

UTC time is also reported within some UBX messages, such as UBX-NAV-TIMEUTC and UBX-NAV-PVT. In these messages date and time are separated into seven distinct integer fields. Six of these (year, month, day, hour, min and sec) have fairly obvious meanings and are all guaranteed to match the corresponding values in NMEA messages generated by the same navigation epoch. This facilitates simple synchronization between associated UBX and NMEA messages.

The seventh field is called nano and it contains the number of nanoseconds by which the rest of the time and date fields need to be corrected to get the precise time. So, for example, the UTC time 12:49:23.521 would be reported as: hour: 12, min: 49, sec: 23, nano: 521000000.

It is however important to note that the first six fields are the result of rounding to the nearest hundredth of a second. Consequently the nano value can range from -5000000 (i.e. -5 ms) to +994999999 (i.e. nearly 995 ms).

When the nano field is negative, the number of seconds (and maybe minutes, hours, days, months or even years) will have been rounded up. Therefore, some or all of them will need to be adjusted in order to get the correct time and date. Thus in an extreme example, the UTC time 23:59:59.9993 on 31st December 2011 would be reported as: year: 2012, month: 1, day: 1, hour: 0, min: 0, sec: 0, nano: -700000.

Of course, if a resolution of one hundredth of a second is adequate, negative nano values can simply be rounded up to 0 and effectively ignored.

Which master clock the UTC time is referenced to is output in the message UBX-NAV-TIMEUTC.

The preferred variant of UTC time can be specified using CFG-NAVSPG-UTCSTANDARD configuration item.

4.8.7 Leap seconds

Occasionally it is decided (by one of the international time keeping bodies) that, due to the slightly uneven spin rate of the Earth, UTC has moved sufficiently out of alignment with mean solar time (i.e. the Sun no longer appears directly overhead at 0 longitude at midday). A "leap second" is therefore announced to bring UTC back into close alignment. This normally involves adding an extra second to the last minute of the year, but it can also happen on 30th June. When this happens UTC clocks are expected to go from 23:59:59 to 23:59:60 and only then on to 00:00:00.

It is also theoretically possible to have a negative leap second, in which case there will only be 59 seconds in a minute and 23:59:58 will be followed by 00:00:00.

u-blox receivers are designed to handle leap seconds in their UTC output and consequently users processing UTC times from either NMEA and UBX messages should be prepared to handle minutes that are either 59 or 61 seconds long.

Leap second information can be polled from the u-blox receiver with the message UBX-NAV-TIMELS for Protocol Version 18 and above.

4.8.8 Real time clock

u-blox receivers contain circuitry to support a real time clock, which (if correctly fitted and powered) keeps time while the receiver is otherwise powered off. When the receiver powers up, it attempts to use the real time clock to initialize receiver local time and in most cases this leads to appreciably faster first fixes.

4.8.9 Date

All GNSS frequently transmit information about the current time within their data message. In most cases, this is a time of week (often abbreviated to TOW), which indicates the elapsed number of seconds since the start of the week (midnight Saturday/Sunday). In order to map this to a full date, it is necessary to know which week and so the GNSS also transmit a week number, typically every 30 seconds. Unfortunately the GPS L1C/A data message was designed in a way that only allows the bottom 10 bits of the week number to be transmitted. This is not sufficient to yield a completely unambiguous date as every 1024 weeks (a bit less than 20 years), the transmitted week number value "rolls over" back to zero. Consequently, GPS L1 receivers can't tell the difference between, for example, 1980, 1999 or 2019 etc.

Fortunately, although BeiDou and Galileo have similar representations of time, they transmit sufficient bits for the week number to be unambiguous for the foreseeable future (the first ambiguity will be in 2078 for Galileo and not until 2163 for BeiDou). GLONASS has a different structure, based on a time of day, but again transmits sufficient information to avoid any ambiguity

during the expected lifetime of the system (the first ambiguous date will be in 2124). Therefore, u-blox 9 receivers using Protocol Version 24 and above regard the date information transmitted by GLONASS, BeiDou and Galileo to be unambiguous and, where necessary, use this to resolve any ambiguity in the GPS date.

 Customers attaching u-blox receivers to simulators should be aware that GPS time is referenced to 6th January 1980, GLONASS to 1st January 1996, Galileo to 22nd August 1999 and BeiDou to 1st January 2006; the receiver cannot be expected to work reliably with signals that appear to come from before these dates.

4.8.9.1 GPS-only date resolution

In circumstances where only GPS L1C/A signals are available and for receivers with earlier firmware versions, the receiver establishes the date by assuming that all week numbers must be at least as large as a reference rollover week number. This reference rollover week number is hard-coded into the firmware at compile time and is normally set a few weeks before the s/w is completed, but it can be overridden by CFG-NAVSPG-WKNROLLOVER configuration item to any value the user wishes.

The following example illustrates how this works: Assume that the reference rollover week number set in the firmware at compile time is 1524 (which corresponds to a week in calendar year 2009, but would be transmitted by the satellites as 500). In this case, if the receiver sees transmissions containing week numbers in the range 500 ... 1023, these will be interpreted as week numbers 1524 ... 2047 (CY 2009 ... 2019), whereas transmissions with week numbers from 0 to 499 are interpreted as week numbers 2048 ... 2547 (CY 2019 ... 2028).

 It is important to set the reference rollover week number appropriately when supplying u-blox receivers with simulated signals, especially when the scenarios are in the past.

4.9 Navigation configuration settings description

This section relates to the configuration group CFG-NAVSPG-*.

4.9.1 Platform settings

u-blox receivers support different dynamic platform models (see table below) to adjust the navigation engine to the expected application environment. These platform settings can be changed dynamically without performing a power cycle or reset. The settings improve the receiver's interpretation of the measurements and thus provide a more accurate position output. Setting the receiver to an unsuitable platform model for the given application environment is likely to result in a loss of receiver performance and position accuracy.

CFG-NAVSPG-DYNMODEL is the configuration item used to select the dynamic model.

Platform	Description
Portable	Applications with low acceleration, e.g. portable devices. Suitable for most situations.
Stationary	Used in timing applications (antenna must be stationary) or other stationary applications. Velocity restricted to 0 m/s. Zero dynamics assumed.
Pedestrian	Applications with low acceleration and speed, e.g. how a pedestrian would move. Low acceleration assumed.
Automotive	Used for applications with equivalent dynamics to those of a passenger car. Low vertical acceleration assumed.
At sea	Recommended for applications at sea, with zero vertical velocity. Zero vertical velocity assumed. Sea level assumed.
Airborne <1g	Used for applications with a higher dynamic range and greater vertical acceleration than a passenger car. No 2D position fixes supported.
Airborne <2g	Recommended for typical airborne environments. No 2D position fixes supported.
Airborne <4g	Only recommended for extremely dynamic environments. No 2D position fixes supported.

Platform	Description
Wrist	Only recommended for wrist worn applications. Receiver will filter out arm motion. (just available for protocol version > 17)

Table 18: Dynamic Platform Models

Platform	Max Altitude [m]	MAX Horizontal Velocity [m/s]	MAX Vertical Velocity [m/s]	Sanity check type	Max Position Deviation
Portable	12000	310	50	Altitude and Velocity	Medium
Stationary	9000	10	6	Altitude and Velocity	Small
Pedestrian	9000	30	20	Altitude and Velocity	Small
Automotive	6000	100	15	Altitude and Velocity	Medium
At sea	500	25	5	Altitude and Velocity	Medium
Airborne <1g	50000	100	100	Altitude	Large
Airborne <2g	50000	250	100	Altitude	Large
Airborne <4g	50000	500	100	Altitude	Large
Wrist	9000	30	20	Altitude and Velocity	Medium

Table 19: Dynamic Platform Model Details

Dynamic platforms designed for high acceleration systems (e.g. airborne <2g) can result in a higher standard deviation in the reported position.

If a sanity check against a limit of the dynamic platform model fails, then the position solution is invalidated. The table above shows the types of sanity checks which are applied for a particular dynamic platform model.

4.9.2 Navigation input filters

The navigation input filters in CFG-NAVSPG-* configuration group provide the input data of the navigation engine.

Configuration item	Description
CFG-NAVSPG-FIXMODE	By default, the receiver calculates a 3D position fix if possible but reverts to 2D position if necessary (Auto 2D/3D). The receiver can be forced to only calculate 2D (2D only) or 3D (3D only) positions.
CFG-NAVSPG-CONSTR_ALT, CFG-NAVSPG-CONSTR_ALTVAR	The fixed altitude is used if fixMode is set to 2D only. A variance greater than zero must also be supplied.
CFG-NAVSPG-INFIL_MINELEV	Minimum elevation of a satellite above the horizon in order to be used in the navigation solution. Low elevation satellites may provide degraded accuracy, due to the long signal path through the atmosphere.
CFG-NAVSPG-INFIL_NCNOTHRS, CFG-NAVSPG-INFIL_CNOTHRS	A navigation solution will only be attempted if there are at least the given number of SVs with signals at least as strong as the given threshold.

Table 20: Navigation Input Filter parameters

4.9.3 Navigation output filters

The result of a navigation solution is initially classified by the fix type (as detailed in the `fixType` field of UBX-NAV- PVT message). This distinguishes between failures to obtain a fix at all ("No Fix") and cases where a fix has been achieved, which are further subdivided into specific types of fixes (e.g. 2D, 3D, dead reckoning).



The ZED-F9P firmware does not support the dead reckoning position fix type.

Where a fix has been achieved, a check is made to determine whether the fix should be classified as valid or not. A fix is only valid if it passes the navigation output filters as defined in CFG-NAVSPG-OUTFIL. In particular, both PDOP and accuracy values must lie below the respective limits.

 Important: Users are recommended to check the `gnssFixOK` flag in the UBX-NAV-PVT or the NMEA valid flag. Fixes not marked valid should not normally be used.

UBX-NAV-STATUS message also reports whether a fix is valid in the `gpsFixOK` flag. These messages have only been retained for backwards compatibility and users are recommended to use the UBX-NAV-PVT message in preference.

The CFG-NAVSPG-OUTFIL_TDOP and CFG-NAVSPG-OUTFIL_TACC configuration items also define TDOP and time accuracy values that are used in order to establish whether a fix is regarded as locked to GNSS or not, and as a consequence of this, which time pulse setting has to be used. Fixes that do not meet both criteria will be regarded as unlocked to GNSS, and the corresponding time pulse settings of CFG-TP-* configuration group will be used to generate a time pulse.

4.9.3.1 Speed (3-D) Low-pass filter

The CFG-ODO-OUTLPVEL configuration item offers the possibility to activate a speed (3D) low-pass filter. The output of the speed low-pass filter is published in the UBX-NAV-VELNED message (`speed` field). The filtering level can be set via the CFG-ODO-VELLPGAIN configuration item and must be comprised between 0 (heavy low-pass filtering) and 255 (weak low-pass filtering).

 Strictly speaking, the internal filter gain is computed as a function of speed. Therefore, the level as defined in the CFG-ODO-VELLPGAIN configuration item defines the nominal filtering level for speeds below 5m/s.

4.9.3.2 Course over ground low-pass filter

The CFG-ODO-OUTLPCOG configuration item offers the possibility to activate a course over ground low-pass filter when the speed is below 8m/s. The output of the course over ground (also named heading of motion 2-D) low-pass filter is published in the UBX-NAV-PVT message (`headMot` field), UBX-NAV-VELNED message (`heading` field), NMEA-RMC message (`cog` field) and NMEA-VTG message (`cogt` field). The filtering level can be set via the CFG-ODO-COGLPGAIN configuration item and must be comprised between 0 (heavy low-pass filtering) and 255 (weak low-pass filtering).

 The filtering level as defined in the CFG-ODO-COGLPGAIN configuration item defines the filter gain for speeds below 8m/s. If the speed is higher than 8m/s, no course over ground low-pass filtering is performed.

4.9.3.3 Low-speed course over ground filter

The CFG-ODO-USE_COG activates this feature and the CFG-ODO-COGMAXSPEED, CFG-ODO-COGMAXPOSACC configuration items offer the possibility to configure a low-speed course over ground filter (also named heading of motion 2D). This filter derives the course over ground from position at very low speed. The output of the low-speed course over ground filter is published in the UBX-NAV-PVT message (`headMot` field), UBX-NAV-VELNED message (`heading` field), NMEA-RMC message (`cog` field) and NMEA-VTG message (`cogt` field). If the low-speed course over ground filter is not activated or inactive, then the course over ground is computed as described in section Freezing the Course Over Ground.

4.9.4 Static hold

Static Hold Mode allows the navigation algorithms to decrease the noise in the position output when the velocity is below a pre-defined "Static Hold Threshold". This reduces the position wander caused by environmental factors such as multi-path and improves position accuracy especially in stationary applications. By default, static hold mode is disabled.

If the speed drops below the defined "Static Hold Threshold", the Static Hold Mode will be activated. Once Static Hold Mode has been entered, the position output is kept static and the velocity is set to zero until there is evidence of movement again. Such evidence can be velocity, acceleration, changes of the valid flag (e.g. position accuracy estimate exceeding the Position Accuracy Mask, see also section Navigation Output Filters), position displacement, etc.

The CFG-MOT-GNSSDIST_THRS, configuration item additionally allows for configuration of distance threshold. If the estimated position is farther away from the static hold position than this threshold, static mode will be quit. The CFG-MOT-GNSSSPEED_THRS configuration item allows you to set a speed that the static hold will release.

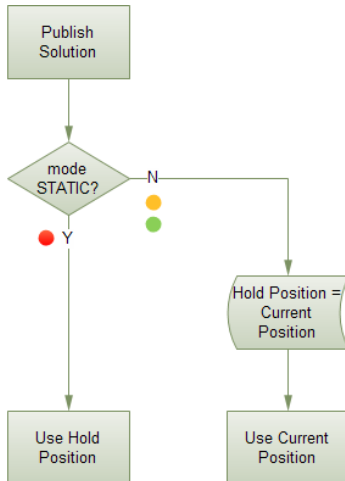

Figure 33: Position publication in static hold mode

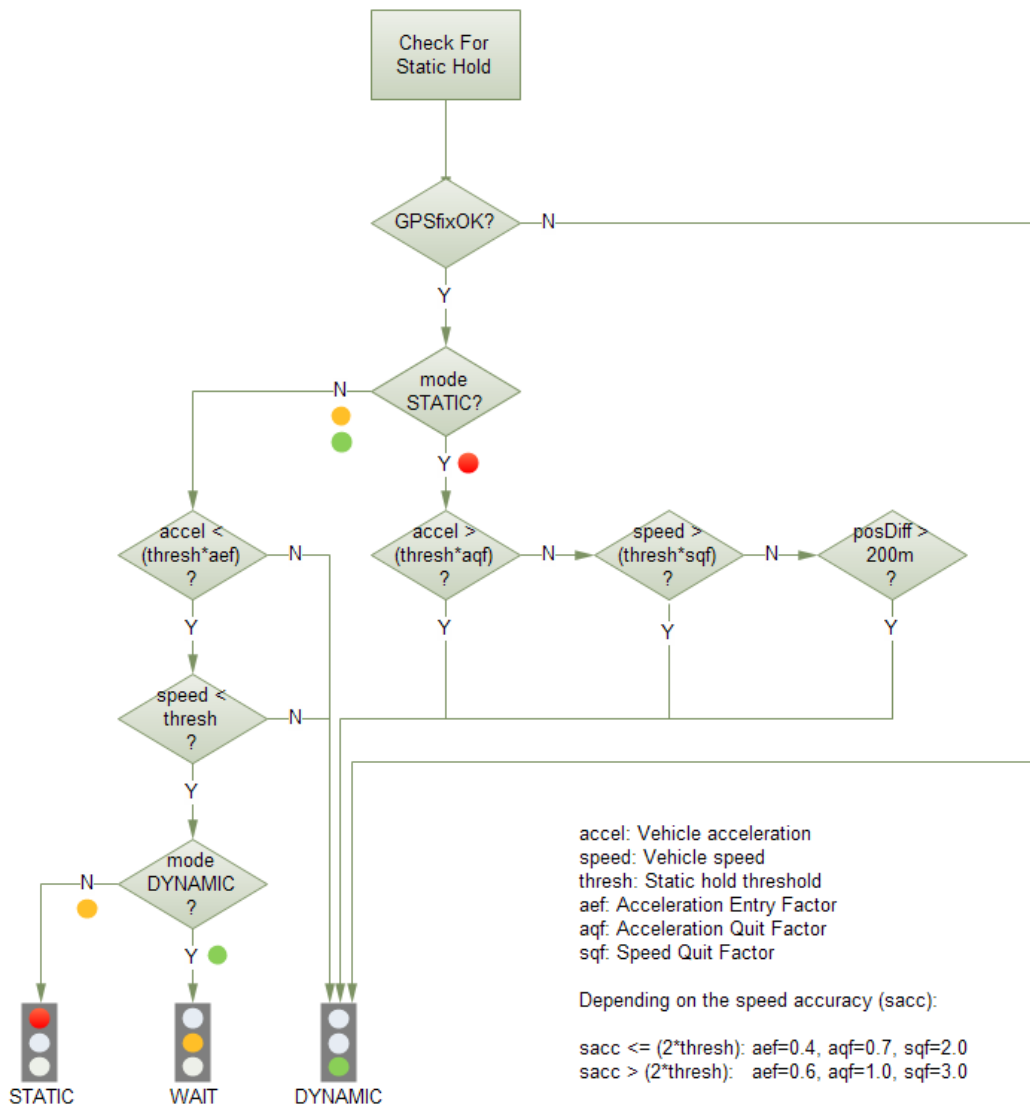

Figure 34: Flowchart of the static hold mode

4.9.5 Freezing the course over ground

If the low-speed course over ground filter is deactivated or inactive (see section Low-speed Course over Ground Filter), the receiver derives the course over ground from the GNSS velocity information. If the velocity cannot be calculated with sufficient accuracy (e.g., with bad signals) or if the absolute speed value is very low (under 0.1 m/s) then the course over ground value becomes inaccurate too. In this case the course over ground value is frozen, i.e. the previous value is kept and its accuracy is degraded over time. These frozen values will not be output in the NMEA messages NMEA-RMC and NMEA-VTG unless the NMEA protocol is explicitly configured to do so (see NMEA Protocol Configuration).

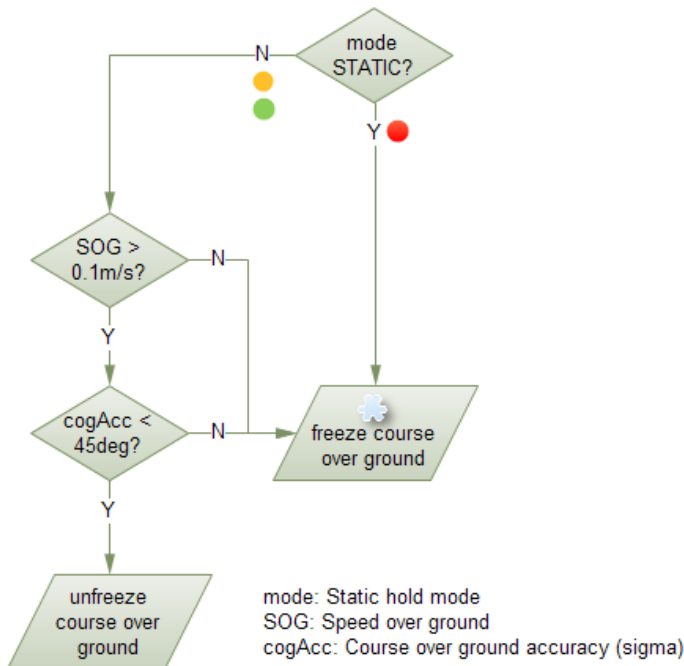

Figure 35: Flowchart of the Course Over Ground freezing

4.9.6 Degraded navigation

Degraded navigation describes all navigation modes which use less than four Satellite Vehicles (SV).

4.9.6.1 2D Navigation

If the receiver only has three SVs for calculating a position, the navigation algorithm uses a constant altitude to compensate for the missing fourth SV. When an SV is lost after a successful 3D fix (min. four SVs available), the altitude is kept constant at the last known value. This is called a 2D fix. u-blox receivers do not calculate any navigation solution with less



u-blox receivers do not calculate any navigation solution with less than three SVs.

4.10 Time pulse

In addition to positioning and navigation applications, GNSS signals are widely used as low cost precision time or frequency references used by remote or distributed wireless communication, industrial, financial, and power distribution equipment. By capitalizing on atomic clocks which are on-board positioning satellites, GNSS signals which contain embedded timing information can be used to synchronize equipment, as well as provide UTC time. For wireless communication standards that utilize Time Division Multiplex (TDM) and applications such as femtocell base stations, a precision time reference is mandatory.

4.10.1 Introduction

u-blox receivers include a time pulse function providing clock pulses with configurable duration and frequency. The time pulse function can be configured using the CFG-TP-* configuration group. The UBX-TIM-TP message provides time information for the next pulse, time source and the quantization error of the output pin.

Pulse Mode: Rising

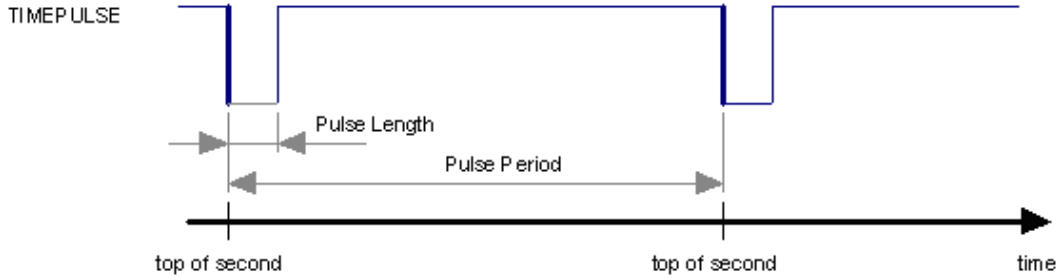
Pulse Mode: Falling

Figure 36: Timepulse

4.10.2 Recommendations

- The time pulse can be aligned to a wide variety of GNSS times or to variants of UTC derived from them (see the chapter on [time bases](#)). However, it is strongly recommended that the choice of time base is aligned with the available GNSS signals (so to produce GPS time or UTC(USNO), ensure GPS signals are available, and for GLONASS time or UTC(SU) ensure the presence GLONASS signals). This will involve coordinating that the setting of CFG-SIGNAL-* configuration group with the choice of time pulse time base.
- When using time pulse for precision timing applications it is recommended to calibrate the antenna cable delay against a reference-timing source.
- Care needs to be given to the cable delay settings in the receiver configuration.
- In order to get the best timing accuracy with the antenna, a fixed and *accurate* position is needed.
- If relative time accuracy between multiple receivers is required, do not mix receivers of different product families. If this is required, the receivers must be calibrated accordingly, by setting cable delay and user delay.
- The recommended configuration when using the UBX-TIM-TP message is to set both the measurement rate (CFG-RATE-MEAS) and the time pulse frequency (CFG-TP-*) to 1Hz.



Since the rate of UBX-TIM-TP is bound to the measurement rate, more than one UBX-TIM-TP message can appear between two pulses if the measurement rate is set larger than the time pulse frequency. In this case all UBX-TIM-TP messages in between a time pulse T1 and T2 belong to T2 and the last UBX-TIM-TP before T2 reports the most accurate quantization error. In general, if the navigation solution rate and time pulse rate are configured to different values, there will not be a single UBX-TIM-TP message for each time pulse.

The sequential order of the signal present at the TIMEPULSE pin and the respective output message for the simple case of 1 pulse per second (1PPS) and a one second navigation update rate is shown in the following figure.

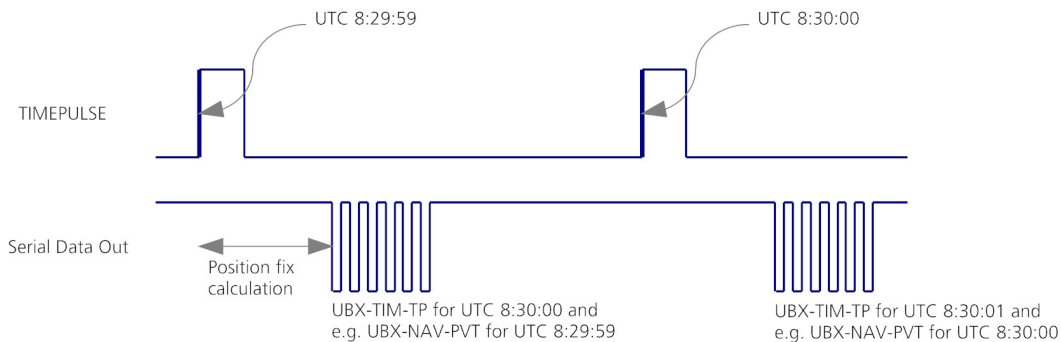

Figure 37: Timepulse and TIM-TP



4.10.3 GNSS time bases

GNSS receivers must handle a variety of different time bases as each GNSS has its own reference system time. What is more, although each GNSS provides a model for converting their system time into UTC, they all support a slightly different variant of UTC. So, for example, GPS supports a variant of UTC as defined by the US National Observatory, while BeiDou uses UTC from the National Time Service Center, China (NTSC). While the different UTC variants are normally closely aligned, they can differ by as much as a few hundreds of nanoseconds.

Although u-blox receivers can combine a variety of different GNSS times internally, the user must choose a single type of GNSS time and, separately, a single type of UTC for input (on EXTINTs) and output (via the Time Pulse) and the parameters reported in corresponding messages.

The CFG-TP-* configuration group allows the user to choose between any of the supported GNSS (GPS, GLONASS, BeiDou, etc) times and UTC. Also, the CFG-NAVSPG-* configuration group allows the user to select which variant of UTC the receiver should use. This includes an "automatic" option which causes the receiver to select an appropriate UTC version itself, based on the GNSS configuration, using, in order of preference, USNO if GPS is enabled, SU if GLONASS is enabled, NTSC if BeiDou is enabled and, finally, European if Galileo is enabled.

The receiver will assume that the input time pulse uses the same GNSS time base as specified for the output using CFG-TP-*. So if the user selects GLONASS time for time pulse output, any time pulse input must also be aligned to GLONASS time (or to the separately chosen variant of UTC). Where UTC is selected for time pulse output, any GNSS time pulse input will be assumed to be aligned to GPS time.

-  u-blox receivers allow users to choose independently GNSS signals used in the receiver (using CFG-SIGNAL-*) and the input/output time base (using CFG-TP-*). For example it is possible to instruct the receiver to use GPS and GLONASS satellite signals to generate BeiDou time. This practice will compromise time-pulse accuracy if the receiver cannot measure the timing difference between the constellations directly and is not recommended.
-  The information that allows GNSS times to be converted to the associated UTC times is only transmitted by the GNSS at relatively infrequent periods. For example GPS transmits UTC(USNO) information only once every 12.5 minutes. Therefore, if a Time Pulse is configured to use a variant of UTC time, after a cold start, substantial delays before the receiver has sufficient information to start outputting the Time Pulse can be expected.

4.10.4 Time pulse configuration

u-blox ZED-F9P receivers provide a time pulse (TP) signal with a configurable pulse period, pulse length and polarity (rising or falling edge).

It is possible to define different signal behavior (i.e. output frequency and pulse length) depending on whether or not the receiver is locked to a reliable time source. Time pulse signals can be configured using the configuration group CFG-TP-*

4.10.5 Configuring time pulse with CFG-TP-*

The configuration group CFG-TP-* can be used to change the time pulse settings, and includes the following parameters defining the pulse:

- **timepulse enable** - time pulse will be active if this bit is set.
- **time pulse index** - Index of time pulse output pin to be configured. If a product only has one time pulse output it is typically configurable with index 0.
- **antenna cable delay** - Signal delay due to the cable between antenna and receiver.
- **RF group delay** - Signal delay in the RF module of the receiver (read-only).
- **pulse frequency/period** - Frequency or period time of the pulse when locked mode is not configured or active.
- **pulse frequency/period lock** - Frequency or period time of the pulse, as soon as receiver has calculated a valid time from a received signal. Only used if the corresponding flag is set to use another setting in locked mode.
- **pulse length/ratio** - Length or duty cycle of the generated pulse, either specifies a time or ratio for the pulse to be on/off.
- **pulse length/ratio lock** - Length or duty cycle of the generated pulse, as soon as receiver has calculated a valid time from a received signal. Only used if the corresponding flag is set to use another setting in locked mode.
- **user delay** - The cable delay from the receiver to the user device plus signal delay of any user application.
- **lock to gps freq** - Use frequency gained from GPS signal information rather than local oscillator's frequency if flag is set.
- **lock to gnss freq** - Use frequency gained from GNSS signal information rather than local oscillator's frequency if flag is set.
- **locked other setting** - If this bit is set, as soon as the receiver can calculate a valid time, the alternative setting is used. This mode can be used for example to disable time pulse if time is not locked, or indicate lock with different duty cycles.
- **is frequency** - Interpret the "Frequency/Period" field as frequency rather than period if flag is set.
- **is length** - Interpret the "Length/Ratio" field as length rather than ratio if flag is set.
- **align to TOW** - If this bit is set, pulses are aligned to the top of a second.
- **polarity** - If set, the first edge of the pulse is a rising edge (Pulse Mode: Rising).
- **grid UTC/GPS** - Selection between UTC (0) or GPS (1) timegrid. Also effects the time output by UBX-TIM-TP message.
- **grid UTC/GNSS** - Selection between UTC (0), GPS (1), GLONASS (2) and Beidou (3) timegrid. Also effects the time output by UBX-TIM-TP message.



The maximum pulse length can't exceed the pulse period.



Time pulse settings shall be chosen in such a way, that neither the high nor the low period of the output is less than 50 ns (except when disabling it completely), otherwise pulses can be lost.

4.10.5.1 Example 1

The example below shows the 1PPS TP signal generated on the time pulse output according to the specific parameters of the CFG-TP-* configuration group:

- **CFG-TP-TP1_ENA** = 1
- **CFG-TP-PERIOD_TP1** = 100 000 μ s

- **CFG-TP-LEN_TP1** = 100 000 μ s
- **CFG-TP-TIMEGRID_TP1** = 1 (GPS)
- **CFG-TP-PULSE_LENGTH_DEF** = 0 (Period)
- **CFG-TP-ALIGN_TO_TOW_TP1** = 1
- **CFG-TP-USE_LOCKED_TP1** = 1
- **CFG-TP-POL_TP1** = 1
- **CFG-TP-PERIOD_LOCK_TP1** = 100 000 μ s
- **CFG-TP-LEN_LOCK_TP1** = 100 000 μ s

The 1 Hz output is maintained whether or not the receiver is locked to GPS time. The alignment to TOW can only be maintained when GPS time is locked.

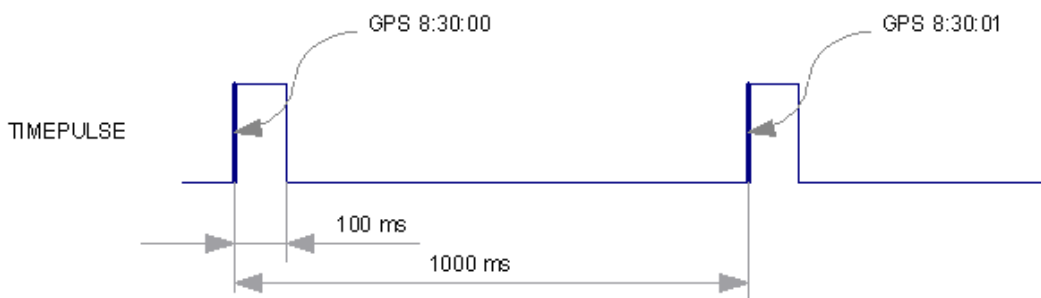

Figure 38: Example 1

4.11 Forcing a receiver reset

Typically, in GNSS receivers, one distinguishes between cold, warm, and hot starts, depending on the type of valid information the receiver has at the time of the restart.

- **Cold start:** In cold start mode, the receiver has no information from the last position (e.g. time, velocity, frequency etc.) at startup. Therefore, the receiver must search the full time and frequency space, and all possible satellite numbers. If a satellite signal is found, it is tracked to decode the ephemeris (18-36 seconds under strong signal conditions), whereas the other channels continue to search satellites. Once there is a sufficient number of satellites with valid ephemeris, the receiver can calculate position and velocity data. Other GNSS receiver manufacturers call this startup mode *Factory Startup*.
- **Warm start:** In warm start mode, the receiver has approximate information for time, position, and coarse satellite position data (Almanac). In this mode, after power-up, the receiver normally needs to download ephemeris before it can calculate position and velocity data. As the ephemeris data usually is outdated after 4 hours, the receiver will typically start with a warm start if it has been powered down for more than 4 hours. In this scenario, several augmentations are possible. See the section on Multi-GNSS Assistance.
- **Hot start:** In hot start mode, the receiver was powered down only for a short time (4 hours or less), so that its ephemeris is still valid. Since the receiver does not need to download ephemeris again, this is the fastest startup method.

In the UBX-CFG-RST message, one can force the receiver to reset and clear data, in order to see the effects of maintaining/losing such data between restarts. For this, the UBX-CFG-RST message offers the `navBbrMask` field, where hot, warm and cold starts can be initiated, and also other combinations thereof.



Data stored in flash memory is not cleared by any of the options provided by UBX-CFG-RST. So, for example, if valid AssistNow Offline data stored in the flash it is likely to have an impact on a "cold start".

The Reset Type can also be specified. This is not related to GNSS, but to the way the software restarts the system.

- **Hardware Reset** uses the on-chip watchdog, in order to electrically reset the chip. This is an immediate, asynchronous reset. No Stop events are generated.
- **Controlled Software Reset** terminates all running processes in an orderly manner and, once the system is idle, restarts operation, reloads its configuration and starts to acquire and track GNSS satellites.
- **Controlled Software Reset (GNSS only)** only restarts the GNSS tasks, without reinitializing the full system or reloading any stored configuration.
- **Controlled GNSS Stop** stops all GNSS tasks. The receiver will not be restarted, but will stop any GNSS related processing.
- **Controlled GNSS Start** starts all GNSS tasks.

4.12 Geofencing

4.12.1 Introduction

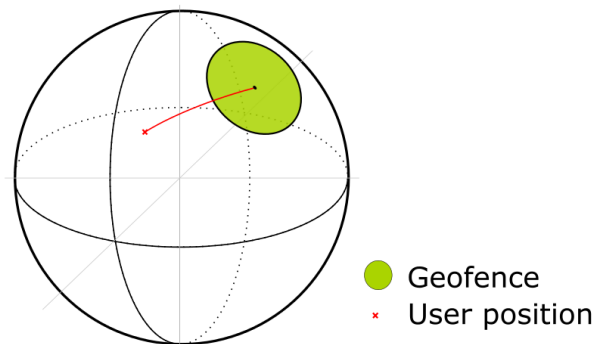

Figure 39: Geofence

The geofencing feature allows for the configuration of up to four circular areas (geofences) on the Earth's surface. The receiver will then evaluate for each of these areas whether the current position lies within the area or not and signal the state via UBX messaging and PIO toggling.

4.12.2 Interface

Geofencing can be configured using the CFG-GEOFENCE-* configuration group. The geofence evaluation is active whenever there is at least one geofence configured.

The current state of each geofence plus the combined state is output in UBX-NAV-GEOFENCE with every navigation epoch.

Additionally the user can configure the receiver to output the combined geofence state on a physical pin.

4.12.3 Geofence state evaluation

With every navigation epoch the receiver will evaluate the current solution's position versus the configured geofences. There are three possible outcomes for each geofence:

- *Inside* - The position is inside the geofence with the configured confidence level
- *Outside* - The position lies outside of the geofence with the configured confidence level
- *Unknown* - There is no valid position solution or the position uncertainty does not allow for unambiguous state evaluation

The position solution uncertainty (standard deviation) is multiplied with the configured confidence sigma level number and taken into account when evaluating the geofence state (red circle in figure below).

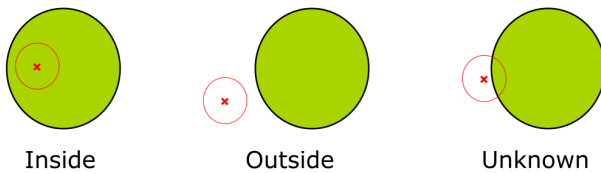

Figure 40: Geofence states

The combined state for all geofences is evaluated as the combination (logical OR) of all geofences:

- *Inside* - The position lies inside of at least one geofence
- *Outside* - The position lies outside of all geofences
- *Unknown* - All remaining states

4.12.4 Using a PIO for geofence state output

This feature can be used for example for waking up a sleeping host when a defined geofence condition is reached. The receiver will toggle the assigned pin according to the *combined* geofence state. Due to hardware restrictions the unknown state will always be represented as HIGH. If the receiver is in software backup or in a reset, the pin will go to HIGH accordingly. The meaning of the LOW state can be configured using CFG-GEOFENCE-PINPOL configuration item.

4.13 Receiver status monitoring

Messages in the UBX class UBX-MON are used to report the status of the parts of the embedded computer system that are not GNSS specific.

The main purposes are:

- Hardware and Software Versions, using UBX-MON-VER
- Status of the Communications Input/Output system, using UBX-MON-COMMS
- Status of various Hardware Sections with UBX-MON-HW3 and UBX-MON-RF

4.13.1 Input/output system

The I/O system is a GNSS-internal layer where all data input- and output capabilities (such as UART, DDC, SPI, USB) of the GNSS receiver are combined. Each communications task has buffers assigned, where data is queued. For data originating at the receiver, to be communicated over one or multiple communications queues, the message UBX-MON-COMMS can be used. This message shows the current and maximum buffer usage, as well as error conditions.



If the amount of data configured is too much for a certain port's bandwidth (e.g. all UBX messages output on a UART port with a baud rate of 9600), the buffer will fill up. Once the buffer space is exceeded, new messages to be sent will be dropped.

Inbound data to the GNSS receiver is placed in buffers. Usage of these buffers is shown with the message UBX-MON-COMMS. Further, as data is then decoded within the receiver (e.g. to separate UBX and NMEA data), the UBX-MON-COMMS message can be used. This message shows (for each port and protocol) how many messages were successfully received. It also shows (for each port) how many bytes were discarded because they were not in any of the supported protocol framings.

4.13.2 Jamming/interference indicator

The field `jamInd` of the UBX-MON-RF message can be used as an indicator for continuous wave (narrow-band) jammers/interference only. The interpretation of the value depends on the

application. It is necessary to run the receiver in an unjammed environment to determine an appropriate value for the unjammed case. If the value rises significantly above this threshold, this indicates that a continuous wave jammer is present.

This indicator is always enabled.

The indicator is reporting any currently detected narrow-band interference over all currently configured signal bands.

4.13.3 Jamming/interference monitor (ITFM)

The field `flags` of the UBX-MON-RF message can be used as an indicator for both broadband and continuous wave (CW) jammers/interference. It is independent of the (CW only) jamming indicator described in [Jamming/Interference Indicator](#) above.

This monitor reports whether jamming has been detected or suspected by the receiver. The receiver monitors the background noise and looks for significant changes. Normally, with no interference detected, it will report "OK". If the receiver detects that the noise has risen above a preset threshold, the receiver reports "Warning". If in addition, there is no current valid fix, the receiver reports "Critical".

The monitor has four states as shown in the following table:

Value	Reported state	Description
0	Unknown	Jamming/interference monitor not enabled, uninitialized or antenna disconnected
1	OK	no interference detected
2	Warning	position ok but interference is visible (above the thresholds)
3	Critical	no reliable position fix and interference is visible (above the thresholds); interference is probable reason why there is no fix

Table 21: Jamming/interference monitor reported states

The monitor is disabled by default. The monitor is enabled by sending an appropriate CFG-ITFM-* configuration group with the CFG-ITFM-ENABLE bit set. In this message it is also possible to specify the thresholds at which broadband and CW jamming are reported. These thresholds should be interpreted as the dB level above "normal". It is also possible to specify whether the receiver expects an active or passive antenna.



The monitor algorithm relies on comparing the currently measured spectrum with a reference from when a good fix was obtained. Thus the monitor will only function when the receiver has had at least one (good) first fix, and will report "Unknown" before this time.

The monitor is reporting any currently detected interference over all currently configured signal bands.

4.14 Host interface signature description

4.14.1 Introduction

The host interface signature feature is designed to help to detect 3rd party attempts to tamper with position and/or time in the host communication channel (i.e. UART).





The level of security of such mechanism depends on how the final system is designed. The feature itself cannot guarantee that the system is secure if the host, the final system HW, and the production setup are not secure.

The feature works by the receiver calculating a numerical signature for the configured messages. The system receiving the message can verify the signature based on the message content and the configured value, termed "seed".

Two new messages are provided for configuring the seed used for the signing: UBX-CFG-FIXSEED and UBX-CFG-DYNSEED.

4.14.2 Configuring the fixed seed and register messages

In the UBX-CFG-FIXSEED message the fixed seed and the set of UBX messages to be signed can be configured.



-  At least one message has to be registered and a maximum of 10 messages are supported.
-  Configuring the set of messages that are signed will not enable these messages by default.
-  All UBX messages can be signed.
-  This message can only be sent once to the receiver. All subsequent messages will result in a NAK answer.

4.14.3 Configuring the dynamic seed

In the UBX-CFG-DYNSEED message an additional seed can be configured to make a replay attack more difficult. This form of attack stores the messages received from the receiver for a certain time and replays them later.

To prevent such an attack the host can use the time information from the receiver or a dynamic seed. This generates a random seed at regular intervals that is then used by the receiver to sign the outgoing messages.

The frequency of the update on the dynamic seed has to be configured depending on the security concept of the whole system. In case the interval is too long the attacker can store the first set of messages and replay them during the whole period until a new seed is generated. The recommended interval would be in the range of some seconds to a few minutes.

-  By default the dynamic seed is set to: 0x0000_0000_0000_0000.
-  While programming the dynamic seed the receiver may still send signatures which are based on the old seed.

4.14.4 Parsing the signature

The UBX-SEC-SIGN message contains the signature of a previously transmitted message and is always sent after the related message. It is not guaranteed that between the message and the signature no other messages are output.

The payload of UBX-SEC-SIGN contains the reference to the signed message. It can be used to match the related message using the class ID, the message ID and the UBX checksum of the related message. This means that a previously transmitted message is signed when the class ID, the message ID and the UBX checksum match.

4.14.5 Calculate the hash

The picture below shows the layout of the buffer over which the SHA-256 hash is calculated.

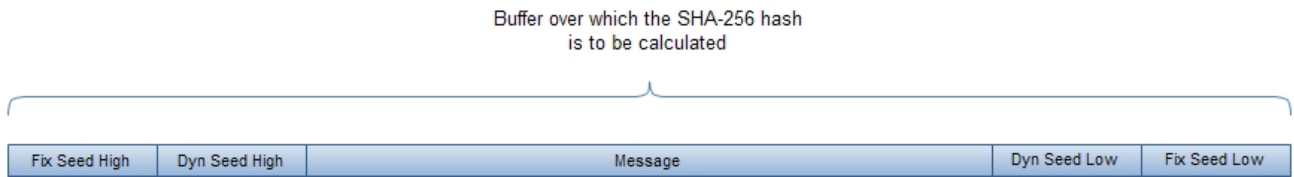

Figure 41: SHA256 hash

The result is a 256 bit (32 bytes) hash which needs to be verified with the content (field *hash*) of the corresponding UBX-SEC-SIGN message.

4.15 Spoofing detection

4.15.1 Introduction

Spoofing is the process whereby someone tries to forge a GNSS signal with the intention of fooling the receiver into calculating a different user position than the true one.

The spoofing detection feature monitors the GNSS signals for suspicious patterns indicating that the receiver is being spoofed. A flag in UBX-NAV-STATUS message (flags2 - spoofDetState) alerts the user to potential spoofing.

4.15.2 Scope

The spoofing detection feature monitors suspicious changes in the GNSS signal indicating external manipulation. Therefore the detection is only successful when the signal is genuine first and when the transition to the spoofed signal is being observed directly. When a receiver is started up to a spoofed signal the detection algorithms will be unable to recognize the spoofing. Also, the algorithms rely on availability of signals from multiple GNSS; the detection does not work in single GNSS mode.

4.16 Timemark

The receiver can be used to provide an accurate measurement of the time at which a pulse was detected on the external interrupt pin. The reference time can be chosen by setting the time source parameter to UTC, GPS, GLONASS, BeiDou, Galileo or local time in the CFG-TP-* configuration group. The UTC standard can be set in the CFG-NAVSPG-* configuration group. The delay figures defined with CFG-TP-* are also applied to the results output in the UBX-TIM-TM2 message.

A UBX-TIM-TM2 message is output at the next epoch if

- The UBX-TIM-TM2 message is enabled
- A rising or falling edge was triggered since last epoch on one of the EXTINT channels

The UBX-TIM-TM2 messages includes the time of the last timemark, new rising/falling edge indicator, time source, validity, number of marks and a quantization error. The timemark is triggered continuously.



Only the last rising and falling edge detected between two epochs is reported since the output rate of the UBX-TIM-TM2 message corresponds to the measurement rate configured with CFG-RATE-MEAS (see Figure below).

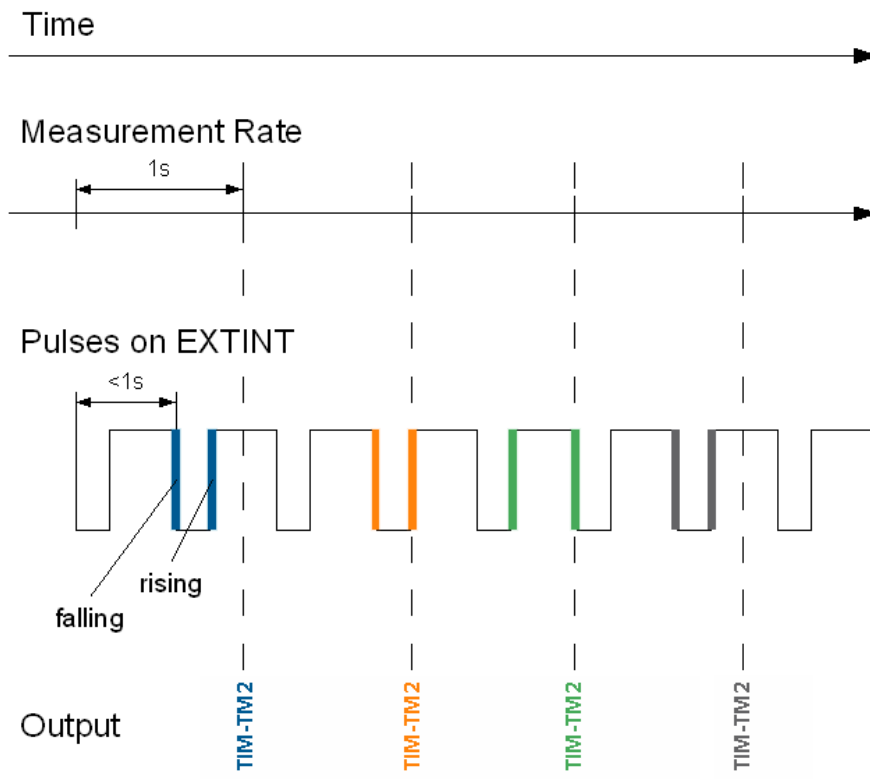

Figure 42: Timemark

5 Hardware description

5.1 Block diagram

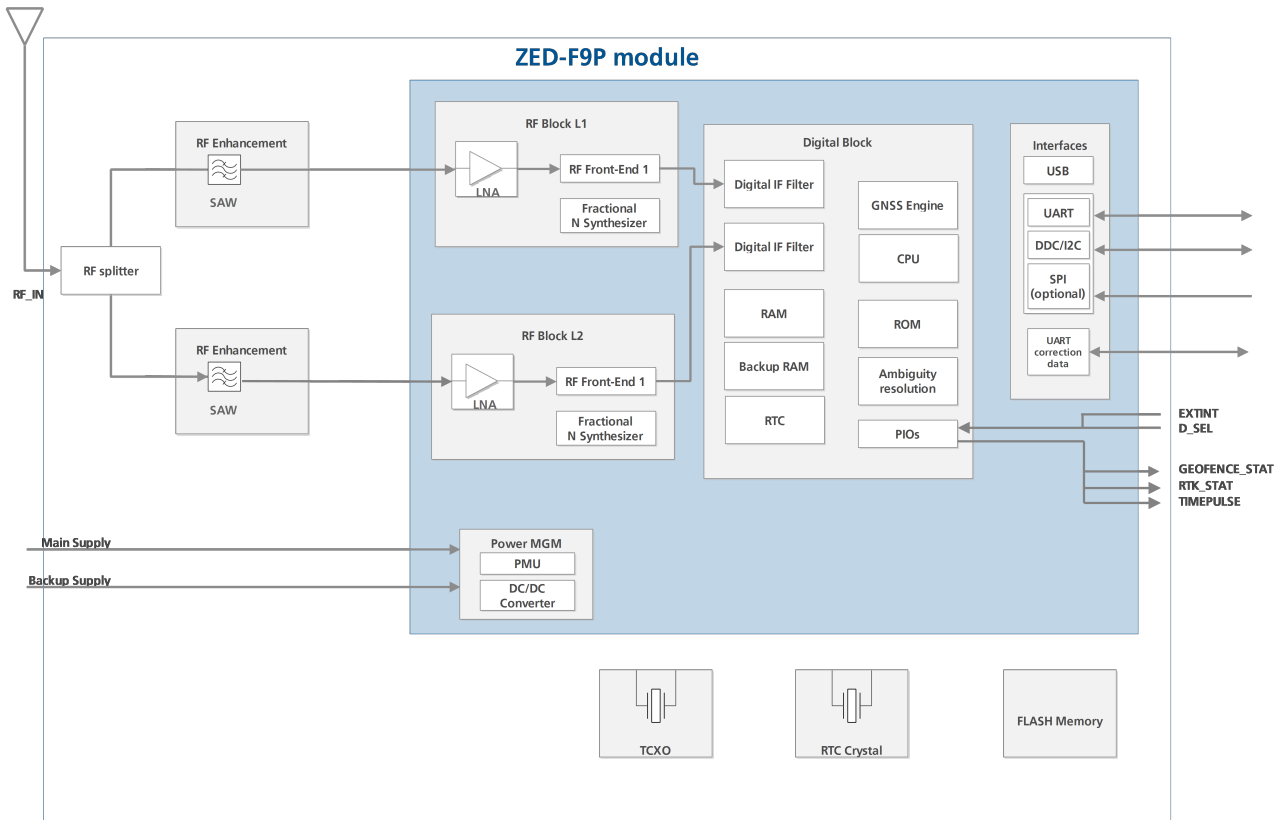

Figure 43: ZED-F9P block diagram

An active antenna is mandatory with the ZED-F9P.

5.2 Connecting power





The u-blox ZED-F9P module has two power supply pins: VCC, V_BCKP.

5.2.1 VCC: Main supply voltage

The **VCC** pin provides the main supply voltage. During operation, the current drawn by the module can vary by some orders of magnitude. For this reason, it is important that the supply circuitry be able to support the peak power for a short time (see the u-blox u-blox ZED-F9P Data sheet [1] for specification).



The module integrates a DC/DC converter, which allows reduced power consumption.

When switching from backup mode to normal operation or at start-up, u-blox ZED-F9P modules must charge the internal capacitors in the core domain. In certain situations, this can result in a significant current draw. For low power applications using backup mode, it is important that the power supply or low ESR capacitors at the module input can deliver this current/charge.

-  Use a LDO for the ZED-F9P that has an in built current limiter. This ensures that the charging of module capacitance during power on does not draw too high a peak current. For example a LDO with a current limiter of 500 mA. The ZED-F9P will require a minimum of 300 mA with no voltage drop during normal powered operation.
-  Do not use any resistors or coils in the power line.
-  Do not add any series resistance greater than 0.2 Ω to the VCC supply as it will generate input voltage noise due to dynamic current conditions.
-  For the ZED-F9P module the equipment must be supplied by an external limited power source in compliance with the clause 2.5 of the standard IEC 60950-1.

5.2.2 V_BCKP: Backup supply voltage

If the module supply has a power failure, the **V_BCKP** pin supplies the real-time clock (RTC) and battery backed RAM (BBR). Use of valid time and the GNSS orbit data at start up will improve the GNSS performance, as with hot starts and warm starts. If no backup battery is connected, the module performs a cold start at power up.

-  Avoid high resistance on the **V_BCKP** line: During the switch from main supply to backup supply, a short current adjustment peak can cause a high voltage drop on the pin with possible malfunctions.
-  If no backup supply voltage is available, connect the **V_BCKP** pin to **VCC**.
-  Allow all I/O including UART and other interfaces to Float/High impedance in HW backup mode (Battery Back-up connected with VCC removed). Please see the "interfaces" section.

Real-Time Clock (RTC)

The Real-Time Clock (RTC) is driven by a 32 kHz oscillator using an RTC crystal. If the main supply voltage fails, and a battery is connected to **V_BCKP**, parts of the receiver switch off, but the RTC still runs providing a timing reference for the receiver. This operating mode is called Hardware Backup Mode, which enables all relevant data to be saved in the backup RAM to allow a hot or warm start later.

5.2.3 ZED-F9P Power supply

The ZED-F9P high precision receiver requires a low noise, low dropout voltage, very low source impedance power supply of 3.3V typically. No inductors or Ferrite beads should be used from LDO to the module VCC pin. The peak currents need to be taken into account for the source supplying the LDO for the module.

A power supply fed by 5V is shown in the figure below. This supply is intended just for the module.

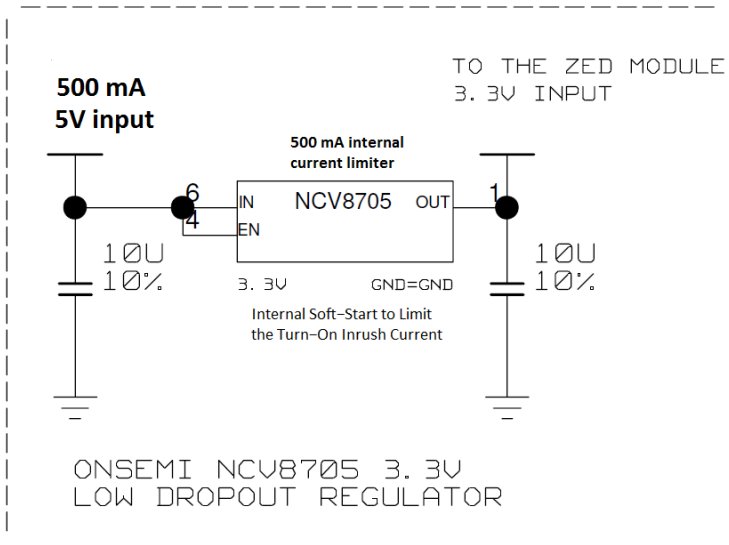

Figure 44: ZED-F9P power supply

5.3 Interfaces

A number of interfaces are available in the ZED-F9P high precision receiver (UART, DDC or SPI), but not all are supported by the default firmware for data communication. See the ZED-F9P Interface Description [2] for a description of the interface protocols supported.



It is important to isolate all receiver I/O when VCC is not applied. This is also the case if V_BCKP is used. The receiver I/O should be allowed to float or connected to a high impedance if VCC is not applied.

It is advised to use the module VCC for any pull up, level translation or buffer circuits to ensure compatibility with the module I/O levels and required states.

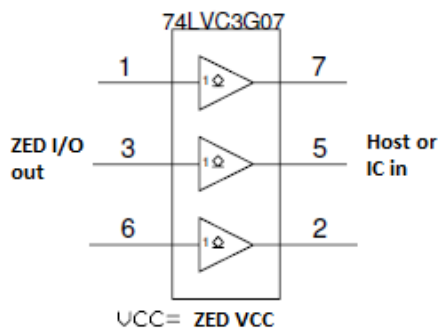

Figure 45: ZED-F9P I/O output isolation

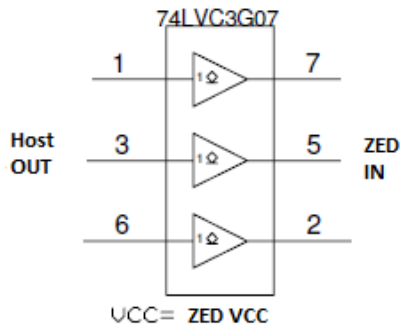

Figure 46: ZED-F9P I/O input isolation

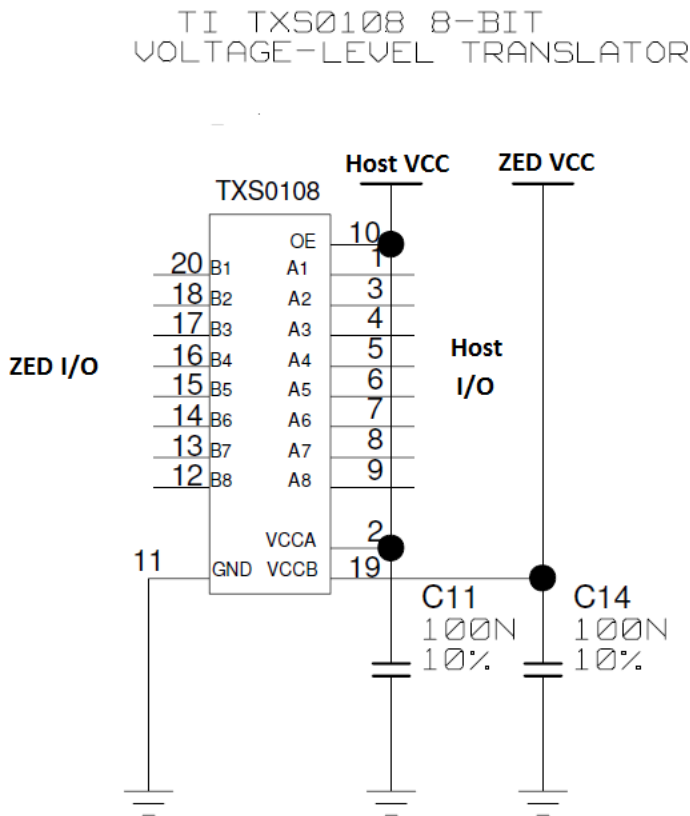

Figure 47: ZED-F9P I/O level translation

5.3.1 UART interfaces

UART1

The ZED-F9P high precision receiver uses a UART interface, which can be used for communication with a host. It supports configurable baud rates.

UART2

UART2 is intended to convey correction messages to the module and will only accept RTCM and NMEA protocols and should not be used as a primary host connection.



With firmware version HPG 1.00 the default baud rate is 38400 baud and it is not recommended to run at a baud rate lower than this with the default NMEA messages.

5.3.2 SPI interface

The ZED-F9P high precision receiver has a SPI slave interface that can be selected by setting `D_SEL = 0`. The SPI slave interface is shared with UART1. The SPI pins available are: `SPI_MISO` (TXD), `SPI_MOSI` (RXD), `SPI_CS_N`, `SPI_CLK`. The SPI interface is designed to allow communication to a host CPU. The interface can be operated in slave mode only. The maximum transfer rate using SPI is 125 kB/s and the maximum SPI clock frequency is 5.5 MHz.

5.3.3 D_SEL interface

At startup, the `D_SEL` pin selects the available interfaces pins between SPI and UART/DDC operation. If `D_SEL` is set high or left open, UART1 and DDC are made available. If `D_SEL` is set low, i.e. connected to ground, the ZED-F9P module can communicate using SPI.

5.3.4 RESET_N interface

The ZED-F9P high precision receiver provides a `RESET_N` pin to reset the system. The `RESET_N` pin is an input-only pin with an internal pull-up resistor. Driving `RESET_N` low resets the module. Pull the pin low for at least 100 ms to ensure correct operation. The `RESET_N` input complies with the VCC level.



The `RESET_N` pin will trigger a cold start and therefore should only be used as a recovery option and not a Power On Reset.

5.3.5 SAFEBOOT_N interface

The ZED-F9P high precision receiver provides a `SAFEBOOT_N` pin that is used to command the receiver into SAFEBOOT.

If this pin is low at power up, the receiver starts in Safe Boot Mode and GNSS operation is disabled.

It can be used to recover from situations where the Flash has become corrupted and needs to be restored.

In Safe Boot mode the receiver runs from a passive oscillator circuit with less accurate timing and hence the receiver is unable to communicate via USB.

In this mode only UART1 and DDC communication is possible. For communication via UART1 in Safe Boot Mode, a training sequence (0x 55 55 at 9600 baud) must be sent by the host to the receiver in order to begin communication. After this the host must wait at least 2 ms before sending any data.

Safe Boot Mode is used in production to program the Flash and to set the Low Level Configuration in the eFuse. It is recommended to have the possibility to pull the `SAFEBOOT_N` pin low in the application. This can be provided using an externally connected test point or a host I/O port.

5.3.6 TIMEPULSE interface

The ZED-F9P high precision receiver provides a time pulse on the `TIMEPULSE` pin.

5.3.7 TX_READY interface

The `TX_READY` function is used to indicate when the receiver has data to transmit. A listener can wait on the `TX_READY` signal instead of polling the DDC or SPI interfaces. The `CFG-TXREADY` message lets you configure the polarity and the number of bytes in the buffer before the `TX_READY` signal goes active. The `TX_READY` function is disabled by default.

5.3.8 USB interface

The USB interface is compatible with the USB version 2.0 FS (Full Speed, 12 Mb/s) interface.

- USB suspend is not supported.
- USB bus powered is not supported.
- It is important to connect V_USB to ground when the USB interface is not used in an application.

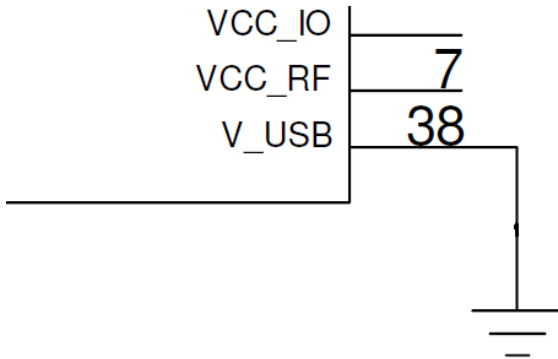

Figure 48: V_USB connected ground if not used

There are additional hardware requirements if USB is designed in to be used:

In *Self Powered Mode* the receiver is powered by its own power supply. V_USB is used to detect the availability of the USB port, i.e. whether the receiver is connected to a USB host.

- Pin 38, V_USB needs to be powered by a separate LDO enabled by module VCC and supplied by the USB host.
- A pull down resistor is required on the output of this V_USB LDO
- V_USB (pin 38) requires a 1 uF and a 100 nF capacitor right next to the pin to ensure correct V_USB voltage detection
- Pin 39 is USB_DM. Pin 40 is USB_DP

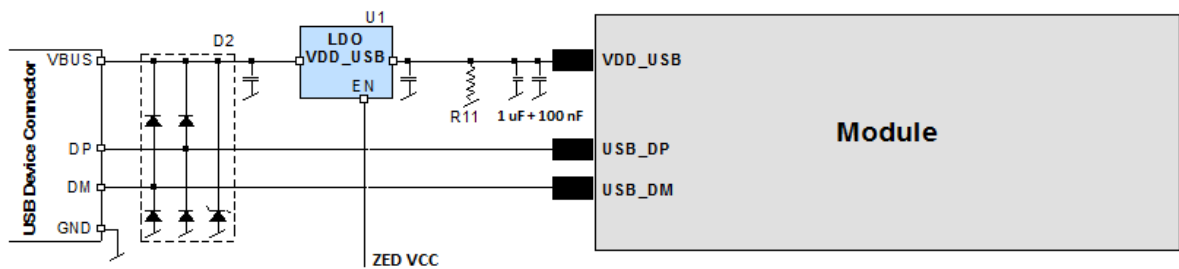

Figure 49: ZED-F9P V_USB supply

R11 = 100 kΩ is recommended.

In USB self-powered mode, the power supply (VCC) can be turned off and the digital block is not powered. In this case, since VBUS is still available, the USB host would still receive a signal indicating that the device is present and ready to communicate. This should be avoided by disabling the LDO (U1) using the enable signal (EN) supplied by the ZED-F9P VCC LDO. Depending on the characteristics of the LDO (U1) it is recommended to add a pull-down resistor (R11) at its output to ensure VDD_USB is not floating if the LDO (U1) is disabled or the USB cable is not connected i.e. VBUS is not supplied.

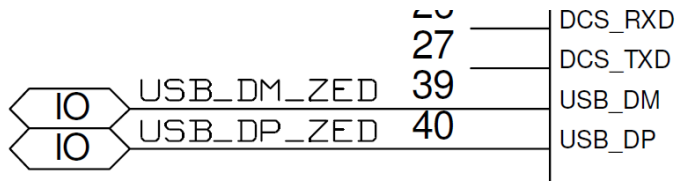

Figure 50: ZED-F9P USB_DM and USB_DP pins

5.3.9 Display Data Channel (DDC)

An I²C compliant DDC interface is available for communication with an external host CPU or u-blox cellular modules. The interface can be operated in slave mode only. The DDC protocol and electrical interface are fully compatible with Fast-Mode of the I²C industry standard. Since the maximum SCL clock frequency is 400 kHz, the maximum transfer rate is 400 kb/s.



The I2C lines need pull up resistors. However they need to be pulled up to module VCC. This ensures the I2C lines are not driven high before VCC is applied.

5.3.10 Antenna supervisor

An active antenna supervisor provides the means to check the antenna for open and short circuits and to shut off the antenna supply if a short circuit is detected. The Antenna Supervisor is configured using serial port UBX binary protocol message. Once enabled, the active antenna supervisor produces status messages, reporting in NMEA and/or UBX binary protocol.

The current setting of the active antenna supervisor can also be checked by polling the related CFG-HW-ANT-* command.

The current active antenna status can be determined by polling the UBX-MON-RF command. If an antenna is connected, the initial state after power-up is "Active Antenna OK" in the u-center UBX-MON-RF view.

The module firmware supports an active antenna supervisor circuit, which is connected to the ANT_DET, ANT_OFF, ANT_SHORT_N pins. For an example the open circuit detection circuit using ANT_DET, "high" = Antenna detected (antenna consumes current); "low" = Antenna not detected (no current drawn).

The following picture details the required circuit and the sections following it detail how to enable and monitor each feature:

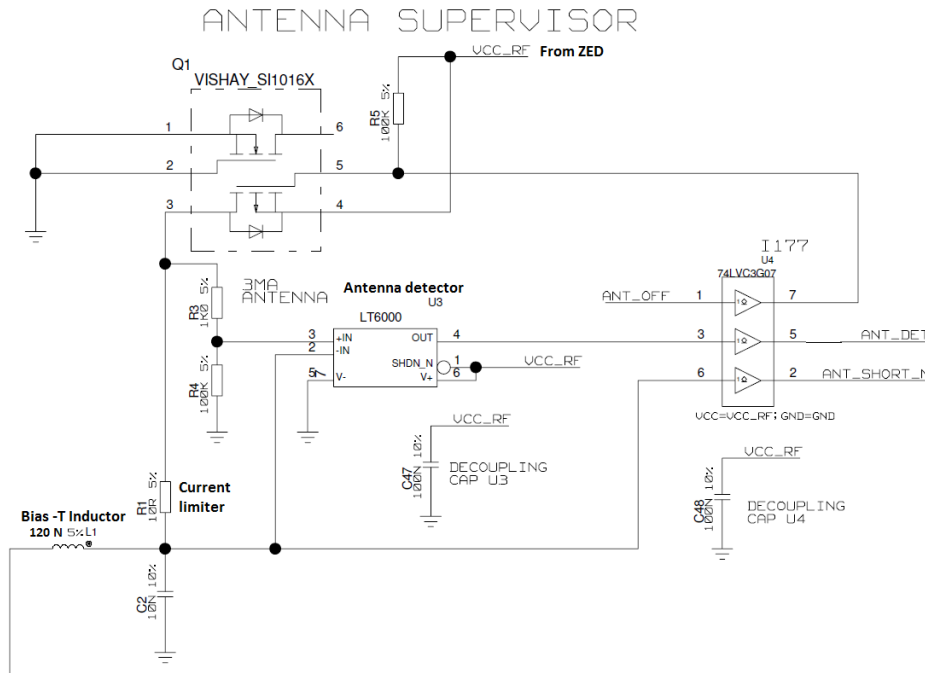

Figure 51: ZED-F9P Antenna Supervisor



The bias-t inductor must be chosen for multi-band operation: a value of 120 nH 5% is recommended

L1: MURATA LQW15A 0402 120N 5% 0.11A -55/+125C

C2: MURATA GRM033R71C103KE14 CER X7R 0402 10N 10% 16V

ESD protection diode on RF trace TYCO, 0.25PF, PESD0402-140 -55/+125C

5.3.10.1 Antenna voltage control - ANT_OFF



Antenna status (as reported in UBX-MON-RF and UBX-INF-NOTICE messages) is not reported unless the antenna voltage control, ANT_OFF, has been enabled.

Set antenna voltage ON:

CFG-HW-ANT_CFG_VOLTCTRL = 1

Result:

- MON-RF in u-center: Antenna status = OK. Antenna power status = ON
- ANT_OFF pin = active high to turn antenna off therefore the pin is low to enable an external antenna.

Start up message at power up if configuration stored:

```
$GNTXT,01,01,02,ANTSUPERV=AC*00
```

```
$GNTXT,01,01,02,ANTSTATUS=INIT*3B
```

```
$GNTXT,01,01,02,ANTSTATUS=OK*25
```

ANTSUPERV=AC indicates antenna control is activated

5.3.10.2 Antenna short detection - ANT_SHORT_N

Then to set Short circuit detect ON:

CFG-HW-ANT_CFG_SHORTDET = 1

Result:

- MON-RF in u-center: Antenna status = OK. Antenna power status = ON
- ANT_OFF = active high to disable an external antenna therefore the pin is low to enable an external antenna.
- ANT_SHORT_N = active low to detect a short therefore the pin is high (pio pull up enabled to be pulled low if shorted)

Start up message at power up if configuration is stored:

```
$GNTXT,01,01,02,ANTSUPERV=AC SD *37
```

```
$GNTXT,01,01,02,ANTSTATUS=INIT*3B
```

```
$GNTXT,01,01,02,ANTSTATUS=OK*25
```

ANTSUPERV=AC SD (Antenna control and short detection activated)

Then if shorted (ANT_SHORT_N pulled low)

- MON-RF in u-center: Antenna status = SHORT. Antenna power status = ON (Antenna power control powerdown when short has not been enabled = off by default)
- \$GNTXT,01,01,02,ANTSTATUS=SHORT*73
- ANT_OFF = active high therefore still low (still enabled as auto power down is not enabled)



Power off and on required to clear short condition report. Or turn feature off and on again.

5.3.10.3 Antenna short detection auto recovery

Then to set automatic recovery from short state:

CFG-HW-ANT_CFG_RECOVER = 1

Result..

- MON-RF in u-center: Antenna status = OK. Antenna power status = ON
- ANT_OFF = active high there for the pio is low to enable an external antenna
- ANT_SHORT_N = high (pio pull up enabled to be pulled low if shorted)

Start up message at power up if config stored:

```
$GNTXT,01,01,02,ANTSUPERV=AC SD PDoS SR*3E
```

```
$GNTXT,01,01,02,ANTSTATUS=INIT*3B
```

```
$GNTXT,01,01,02,ANTSTATUS=OK*25
```

ANTSUPERV=AC SD PDoS SR (indicates short circuit recovery added - SR)

Then if antenna is shorted (ANT_SHORT_N pulled low):

- \$GNTXT,01,01,02,ANTSTATUS=SHORT*73
- MON-RF in u-center: Antenna status = SHORT. Antenna power status = OFF
- ANT_OFF = high (to disable - active high)

After a time out period receiver will re-test the short condition by enabling ANT_OFF = LOW

If a short is not present it will report antenna condition is ok:

```
$GNTXT,01,01,02,ANTSTATUS=OK*25
```

MON-RF in u-center: Antenna status = OK. Antenna power status = ON

5.3.10.4 Antenna open circuit detection - ANT_DETECT

Then to set antenna open circuit detect:

CFG-HW-ANT_CFG_OPENDET = 1

Result..

- MON-RF in u-center: Antenna status = OK. Antenna power status = ON
- ANT_OFF = active high therefore pio is low to enable external antenna
- ANT_SHORT_N = active low therefore pio is high (pio pull up enabled to be pulled low if shorted)
- ANT_DETECT = active high therefore pio is high (pio pull up enabled to be pulled low if ant not detected)

Start up message at power up if config stored:

```
$GNTXT,01,01,02,ANTSUPERV=AC SD OD PDoS SR*15
```

```
$GNTXT,01,01,02,ANTSTATUS=INIT*3B
```

```
$GNTXT,01,01,02,ANTSTATUS=OK*25
```

ANTSUPERV=AC SD OD PDoS SR (indicates open circuit detection added - OD)

Then if ANT_DETECT is pulled low to indicate no antenna:

```
$GNTXT,01,01,02,ANTSTATUS=OPEN*35
```

Then if ANT_DETECT is left floating or it is pulled high to indicate antenna connected:



```
$GNTXT,01,01,02,ANTSTATUS=OK*25
```

5.3.11 EXTINT

EXTINT is an external interrupt pin with fixed input voltage thresholds with respect to VCC. It can be used for functions such as accurate external frequency aiding and ON/OFF control. Leave open if unused, this function is disabled by default.

6 EOS/ESD precautions

When integrating GNSS receivers into wireless systems, careful consideration must be given to electromagnetic and voltage susceptibility issues. Wireless systems include components which can produce Electrostatic Discharge (ESD), Electrical Overstress (EOS) and Electro-Magnetic Interference (EMI). CMOS devices are more sensitive to such influences because their failure mechanism is defined by the applied voltage, whereas bipolar semiconductors are more susceptible to thermal overstress. The following design guidelines are provided to help in designing robust yet cost effective solutions.

-  **Attention** :To avoid overstress damage during production or in the field it is essential to observe strict EOS/ESD/EMI handling and protection measures.
-  **Attention** :To prevent overstress damage at the RF_IN of your receiver, never exceed the maximum input power as specified in the u-blox ZED-F9P Data sheet [1].

6.1 ESD handling precautions

-  **Attention** :ZED-F9P high precision receivers contain highly sensitive electronic circuitry and are Electrostatic Sensitive Devices (ESD). Observe precautions for handling! Failure to observe these precautions can result in severe damage to the GNSS receiver!

- Unless there is a galvanic coupling between the local GND (i.e. the work table) and the PCB GND, then the first point of contact when handling the PCB must always be between the local GND and PCB GND.
- Before mounting an antenna patch, connect ground of the device.
- When handling the RF pin, do not come into contact with any charged capacitors and be careful when contacting materials that can develop charges (e.g. patch antenna ~10 pF, coax cable ~50-80 pF/m, soldering iron, ...)
- To prevent electrostatic discharge through the RF input, do not touch any exposed antenna area. If there is any risk that such exposed antenna area is touched in non ESD protected work area, implement proper ESD protection measures in the design.
- When soldering RF connectors and patch antennas to the receiver's RF pin, make sure to use an ESD safe soldering iron (tip).

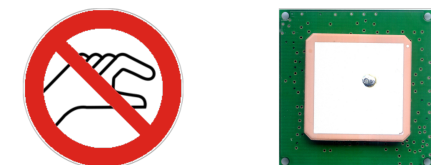

6.2 ESD protection measures

-  **Attention** :GNSS receivers are sensitive to Electrostatic Discharge (ESD). Special precautions are required when handling. Most defects caused by ESD can be prevented by following strict ESD protection rules for production and handling. When implementing passive antenna

patches or external antenna connection points, then additional ESD measures as shown in the figure below can also avoid failures in the field.

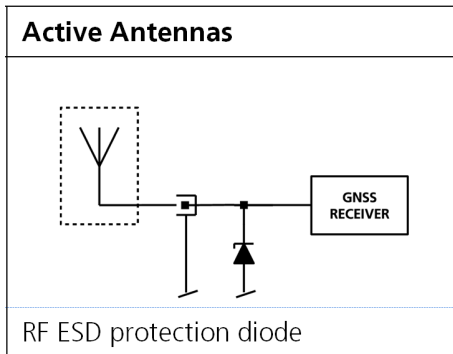

Figure 52: RF ESD precautions

6.3 EOS precautions

Electrical Overstress (EOS) usually describes situations when the maximum input power exceeds the maximum specified ratings. EOS failure can happen if RF emitters are close to a GNSS receiver or its antenna. EOS causes damage to the chip structures. If the RF_IN is damaged by EOS, it's hard to determine whether the chip structures have been damaged by ESD or EOS.

EOS protection measures as shown in the figure below are recommended for any designs combining wireless communication transceivers (e.g. GSM, GPRS) and GNSS in the same design or in close proximity.

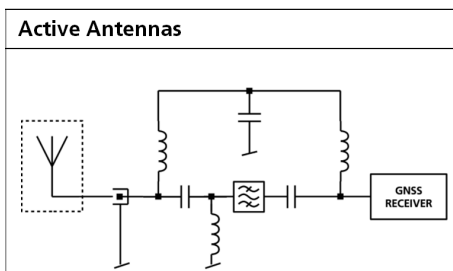

Figure 53: Active antenna EOS protection

6.4 Safety precautions

The ZED-F9P must be supplied by an external limited power source in compliance with the clause 2.5 of the standard IEC 60950-1. In addition to external limited power source, only Separated or Safety Extra-Low Voltage (SELV) circuits are to be connected to the module including interfaces and antennas.



For more information about SELV circuits see section 2.2 in Safety standard IEC 60950-1

7 Electromagnetic interference on I/O lines

Any I/O signal line with a length greater than approximately 3 mm can act as an antenna and may pick up arbitrary RF signals transferring them as noise into the GNSS receiver. This specifically applies to unshielded lines, in which the corresponding GND layer is remote or missing entirely, and lines close to the edges of the printed circuit board.

If, for example, a cellular signal radiates into an unshielded high-impedance line, it is possible to generate noise in the order of volts and not only distort receiver operation but also damage it permanently. Another type of interference can be caused by noise generated at the PIO pins that emits from unshielded I/O lines. Receiver performance may be degraded when this noise is coupled into the GNSS antenna.

EMI protection measures are particularly useful when RF emitting devices are placed next to the GNSS receiver and/or to minimize the risk of EMI degradation due to self-jamming. An adequate layout with a robust grounding concept is essential in order to protect against EMI.



Intended Use: In order to mitigate any performance degradation of a radio equipment under EMC disturbance, system integration shall adopt appropriate EMC design practice and not contain cables over three meters on signal and supply ports.

7.1 General notes on interference issues

Received GNSS signal power at the antenna are very low. At the nominal received signal strength (-128 dBm) it is below the thermal noise floor of -111 dBm . Due to this fact, a GNSS receiver is susceptible to interference from nearby RF sources of any kind. Two cases can be distinguished:

- **Out-of-band interference:** Typically any kind of wireless communications system (e.g. LTE, GSM, CDMA, 3G, WLAN, Bluetooth, etc.) may emit its specified maximum transmit power in close proximity to the GNSS receiving antenna, especially if such a system is integrated with the GNSS receiver. Even at reasonable antenna selectivity, destructive power levels may reach the RF input of the GNSS receiver. Also, larger signal interferers may generate intermodulation products inside the GNSS receiver front-end that fall into the GNSS band and contribute to in-band interference.
- **In-band interference:** Although the GNSS band is kept free from intentional RF signal sources by radio-communications standards, many devices emit RF power into the GNSS band at levels much higher than the GNSS signal itself. One reason is that the frequency band above 1 GHz is not well regulated with regards to EMI, and even if permitted, signal levels are much higher than GNSS signal power. Notably, all types of digital equipment, like PCs, digital cameras, LCD screens, etc. tend to emit a broad frequency spectrum up to several GHz of frequency. Also wireless transmitters may generate spurious emissions that fall into GNSS band.

As an example, GSM uses power levels of up to 2W (+33 dBm). The absolute maximum power input at the RF input of the GNSS receiver can be +15 dBm. The GSM specification allows spurious emissions for GSM transmitters of up to 36 dBm, while the GNSS signal is less than -128 dBm. By simply comparing these numbers it is obvious that interference issues must be seriously considered in any design of a GNSS receiver. Different design goals may be achieved through different implementations:

- The primary focus is prevention of destruction of the receiver from large input signals. Here the GNSS performance under interference conditions is not important and suppression of the GNSS signal is permitted. It is sufficient to just observe the maximum RF power ratings of all the components in the RF input path.
- GNSS performance must be guaranteed even under interference conditions. In that case, not only the maximum power ratings of the components in the receive patch must be

observed. Further, non-linear effects like gain compression, NF degradation (desensitization) and intermodulation must be analyzed.



Pulsed interference with a low duty cycle like e.g. GSM may be destructive due to the high peak power levels.

7.2 In-band interference mitigation

With in-band interference, the signal frequency is very close to the GNSS frequency. Such interference signals are typically caused by harmonics from displays, micro-controller operation, bus systems, etc. Measures against in-band interference include:

- Maintaining a good grounding concept in the design
- Shielding
- Layout optimization
- Low-pass filtering of noise sources, e.g. digital signal lines
- Remote placement of the GNSS antenna, far away from noise sources
- Adding a LTE, CDMA, GSM, WCDMA, BT band-pass filter before antenna

7.3 Out-of-band interference

Out-of-band interference is caused by signal frequencies that are different from the GNSS carrier. The main sources are wireless communication systems such as LTE, GSM, CDMA, WCDMA, WiFi, BT, etc.

Measures against out-of-band interference include maintaining a good grounding concept in the design and adding a GNSS band-pass filter into the antenna input line to the receiver.

For GSM applications, like a typical handset design, an isolation of approximately 20 dB can be reached with careful placement of the antennas. If this is insufficient, an additional SAW filter is required on the GNSS receiver input to block the remaining GSM transmitter energy.

8 Design

This section details the required information to carry out a schematic and PCB design.

8.1 Pin assignment

The pin assignment of the ZED-F9P module is shown in [Figure 54](#). The defined configuration of the PIOs is listed in [Table 22](#).

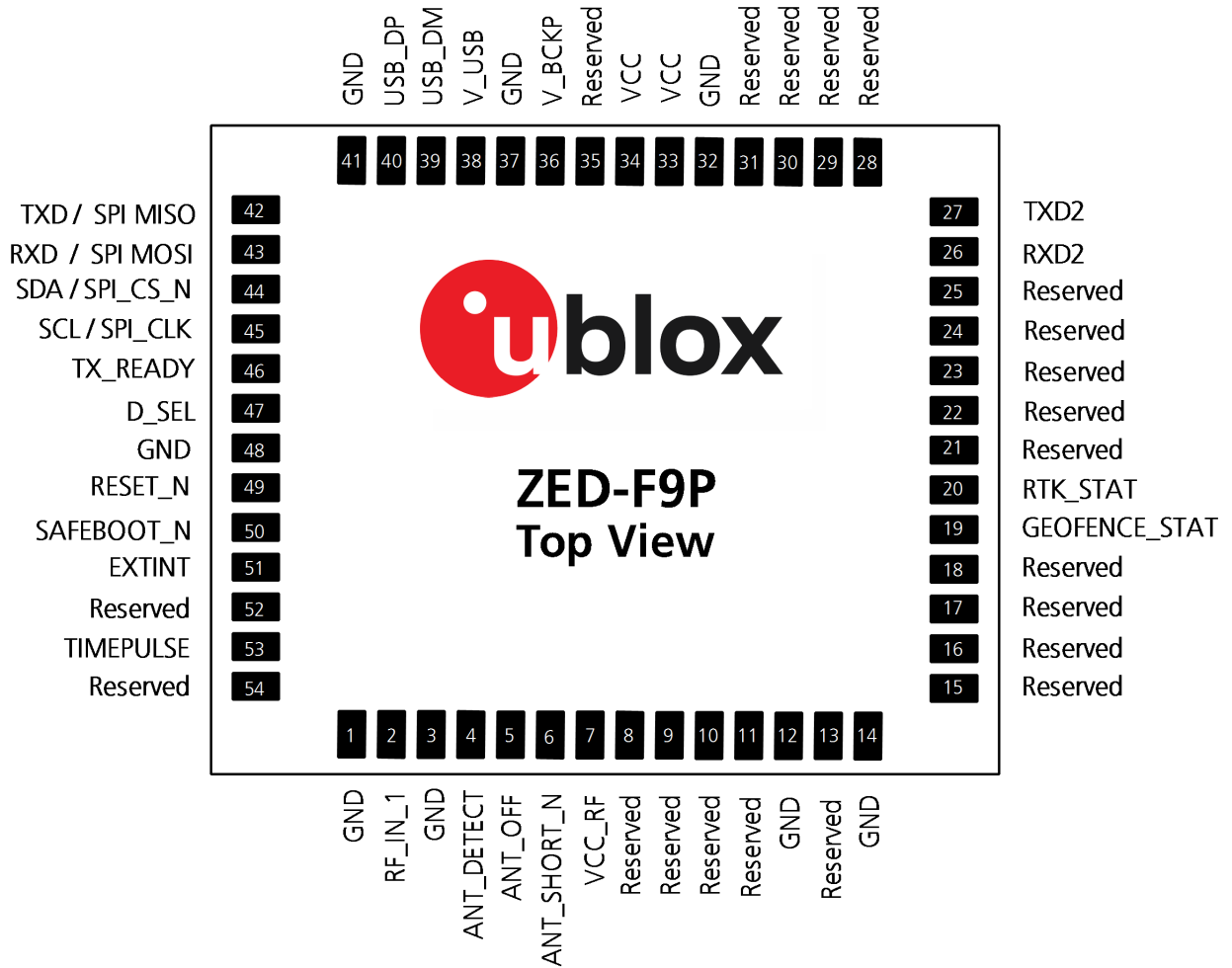

Figure 54: ZED-F9P pin assignment

Pin No	Name	I/O	Description
1	GND	-	Ground
2	RF_IN_1	I	RF input
3	GND	-	Ground
4	ANT_DETECT	I	Active antenna detect - default active high
5	ANT_OFF	O	External LNA disable - default active high
6	ANT_SHORT_N	I	Active antenna short detect - default active low
7	VCC_RF	O	Voltage for external LNA

Pin No	Name	I/O	Description
8	Reserved	-	Reserved
9	Reserved	-	Reserved
10	Reserved	-	Reserved
11	Reserved	-	Reserved
12	GND	-	Ground
13	Reserved	-	Reserved
14	GND	-	Ground
15	Reserved	-	Reserved
16	Reserved	-	Reserved
17	Reserved	-	Reserved
18	Reserved	-	Reserved
19	GEOFENCE_STAT	O	Geofence status, user defined
20	RTK_STAT	O	RTK status 0 – Fixed, blinking – receiving RTCM data, 1 – no corrections
21	Reserved	-	Reserved
22	Reserved	-	Reserved
23	Reserved	-	Reserved
24	Reserved	-	Reserved
25	Reserved	-	Reserved
26	RXD2	I	Correction UART input
27	TXD2	O	Correction UART output
28	Reserved	-	Reserved
29	Reserved	-	Reserved
30	Reserved	-	Reserved
31	Reserved	-	Reserved
32	GND	-	Ground
33	VCC	I	Voltage supply
34	VCC	I	Voltage supply
35	Reserved	-	Reserved
36	V_BCKUP	I	Backup supply voltage
37	GND	-	Ground
38	V_USB	I	USB supply
39	USB_DM	I/O	USB data
40	USB_DP	I/O	USB data
41	GND	-	Ground
42	TXD / SPI MISO	O	Host UART output if D_SEL = 1 (or open). SPI MISO if D_SEL = 0
43	RXD / SPI MOSI	I	Host UART input if D_SEL = 1 (or open). SPI MOSI if D_SEL = 0
44	SDA / SPI_CS_N	I/O	DDC Data if D_SEL = 1 (or open). SPI Chip Select if D_SEL = 0
45	SCL / SPI_CLK	I/O	DDC Clock if D_SEL = 1 (or open). SPI Clock if D_SEL = 0
46	TX_READY	O	TX_Buffer full and ready for TX of data
47	D_SEL	I	Interface select for pins 42-45
48	GND	-	Ground
49	RESET_N	I	RESET_N
50	SAFEBOOT_N	I	SAFEBOOT_N (for future service, updates and reconfiguration, leave OPEN)
51	EXTINT	I	External Interrupt Pin

Pin No	Name	I/O	Description
52	Reserved	-	Reserved
53	TIMEPULSE	O	Time pulse
54	Reserved	-	Reserved

Table 22: ZED-F9P pin assignment

8.2 RF front-end circuit options



It is mandatory that the RF input is fed by an active antenna meeting the requirements for the ZED-F9P.

The first stages of the signal processing chain are crucial to the overall receiver performance.

When an RF input connector is employed this can provide a conduction path for harmful or destructive electrical signals. If this is a likely factor the RF input should be protected accordingly.

Additional points on the RF input

What is the expected quality of the signal source (antenna)?

- What is the external active antenna signal power?
- What is the bandwidth and filtering of the external active antenna?
- Does the external antenna and filtering components meet the group delay variation requirements? This is critical for RTK. Any implementation of a PCB mounted L1/L2 patch antenna and the required RF components should not be attempted without explicit assistance of an antenna manufacturer who has experience in achieving the required group delay variation and bandwidth performance for RTK. u-blox does not have a reference design or recommended components list to achieve this.

Are destructive RF power levels expected to reach the RF-input? Is interference from wireless transmitters expected?

- What are the characteristics of these signals (duty cycle, frequency range, power range, spectral purity)?
- What is the expected GNSS performance under interference conditions?

Is there a risk of RF-input exposure to excessive ESD stress?

- In the field: Is the antenna connector accessible by the user?
- PCB / system assembly: Is there risk that statically charged parts (e.g. patch antennas) may be discharged through the RF-input?

The following subsections provide several options addressing the various questions above:



In some applications, such as GSM transceivers, interference signals may exceed the maximum power rating of the LNA_IN input. To avoid device destruction use of external input protection is mandatory.



During assembly of end-user devices which contain passive patch antennas, an ESD discharge may occur during production when pre-charged antennas are soldered to the GNSS receiver board. In such cases, use of external protection in front of LNA_IN is mandatory to avoid device destruction.

ESD discharge cannot be avoided during assembly and / or field use. Note also that SAW filters are susceptible to ESD damage.



ESD discharge into the RF input cannot be avoided during assembly or field use with this circuit. To provide additional robustness an ESD protection diode can be placed at LNA_IN to GND.

8.3 Antenna

- u-blox highlights that the use of an active antenna is a pre-requisite for using the ZED-F9P.
- If an active antenna needs to be implemented in an application case, it is recommended that an OEM active antenna module is used that meets our specification. To implement the required RF circuitry and source the required components to meet group delay specification is not a simple process compared to previous L1 only implementation.

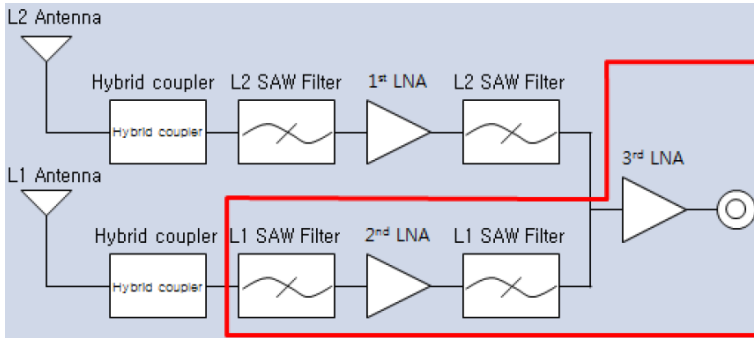

Figure 55: u-blox low cost RTK antenna internal structure

- A suitable ground plane is required for the antenna to achieve good RTK performance.
- Location of the antenna is critical for reaching stated and good RTK performance, not suitable for under vehicle dash location, rear view mirror location, etc.

L1 + L2/E5b active antenna required specifications

Parameter	Specification	
Antenna Type	Active antenna	
Active Antenna Recommendations	Typical gain	30 dB
	Maximum gain	40 dB
	Maximum noise figure	2 dB
L1 band antenna gain ¹	1559 - 1606 MHz: 3 dBic typ.	
L2/E5b band antenna gain ²	1197 - 1249 MHz: 2 dBic typ.	
Polarization	RHCP	
Axial Ratio	2 dB max at Zenith	
Phase Center Variation	<10 mm over Elevation/Azimuth	
Group Delay Variation in-band ³	10 ns max @ each GNSS system bandwidth. Note: Inter-signal requirement 50 ns max.	
EMI immunity out-of-band ⁴	30 V/m	
Out-of-band ⁵ Rejection	40 dB typ	
ESD Circuit Protection	15 kV human body model air discharge	

Table 23: Antenna Specifications for ZED-F9P modules

¹ Measured with a Ground Plane d=150 mm

² Measured with a Ground Plane d=150 mm

³ GNSS system bandwidths: 1559... 1563 MHz; 1573... 1578 MHz; 1598... 1606 MHz; 1192... 1212 MHz; 1197... 1217 MHz; 1223... 1231 MHz; 1242... 1249 MHz

⁴ Exception L1 and L2 bands +/- 200 MHz, emphasis on cellular bands

⁵ GNSS system bandwidths: 1559... 1563 MHz; 1573... 1578 MHz; 1598... 1606 MHz; 1192... 1212 MHz; 1197... 1217 MHz; 1223... 1231 MHz; 1242... 1249 MHz

The antenna system should include filtering to ensure adequate protection from nearby transmitters. Care should be taken in the selection of antennas placed close to cellular or WiFi transmitting antennas.

8.4 Stacked patch antenna

The typical L1 + L2 antenna will be a stacked patch antenna design. There will be a discrete L1 patch on top of a L2 patch.

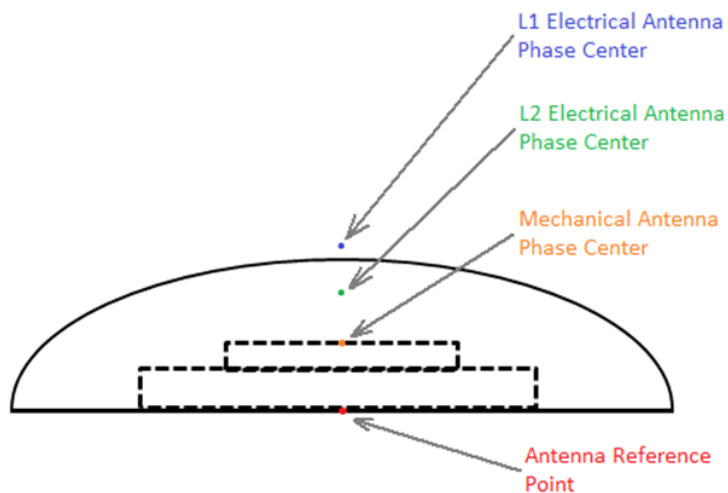

Figure 56: Stacked patch antenna

It is important to note that the absolute position of the antenna placement needs to be calculated from the L1/L2 phase-variation. The L1 and L2 patch phase centers must vary to a minimum. The final Antenna Reference point or ARP is then used to calculate the actual precise antenna position.

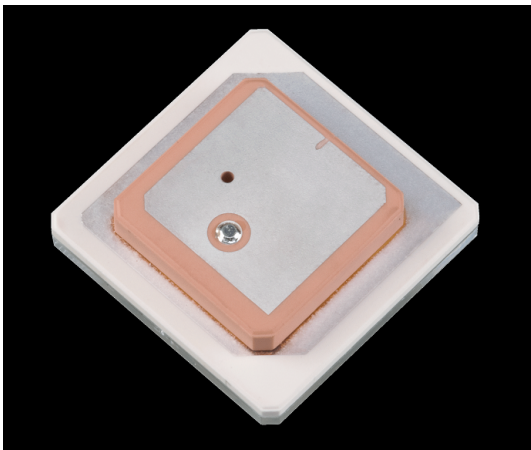

Figure 57: Ceramic Stack

If the antenna is to be used in an automotive application in mass production. The final placement of the antenna will affect the Phase center variation, the antenna ground plane size and shape and the antenna location to other bodies or structures will cause offsets. The final Phase center variation calibration will need to be done on the final vehicle with the antenna in its final location. If the phase variation of a specific antenna is repeatable between samples, the Phase center variation can be calibrated successfully.

The absolute best performance will be obtained with the antenna in the center of the roof and not tilted at any large angle. However the placement of automotive antenna in a mass production vehicle will probably be compromised.

The antenna cannot be placed under a dashboard, in a rear view mirror or on the rear parcel shelf. It needs to have very good signal levels and the wide as possible view of the sky.

Low cost L1 + L2 stacked patch antenna must have a minimum band pass performance from their patch elements and the required internal SAW filtering. An example of the actual measured Band pass characteristics of a low cost L1 + L2 antenna is shown below.

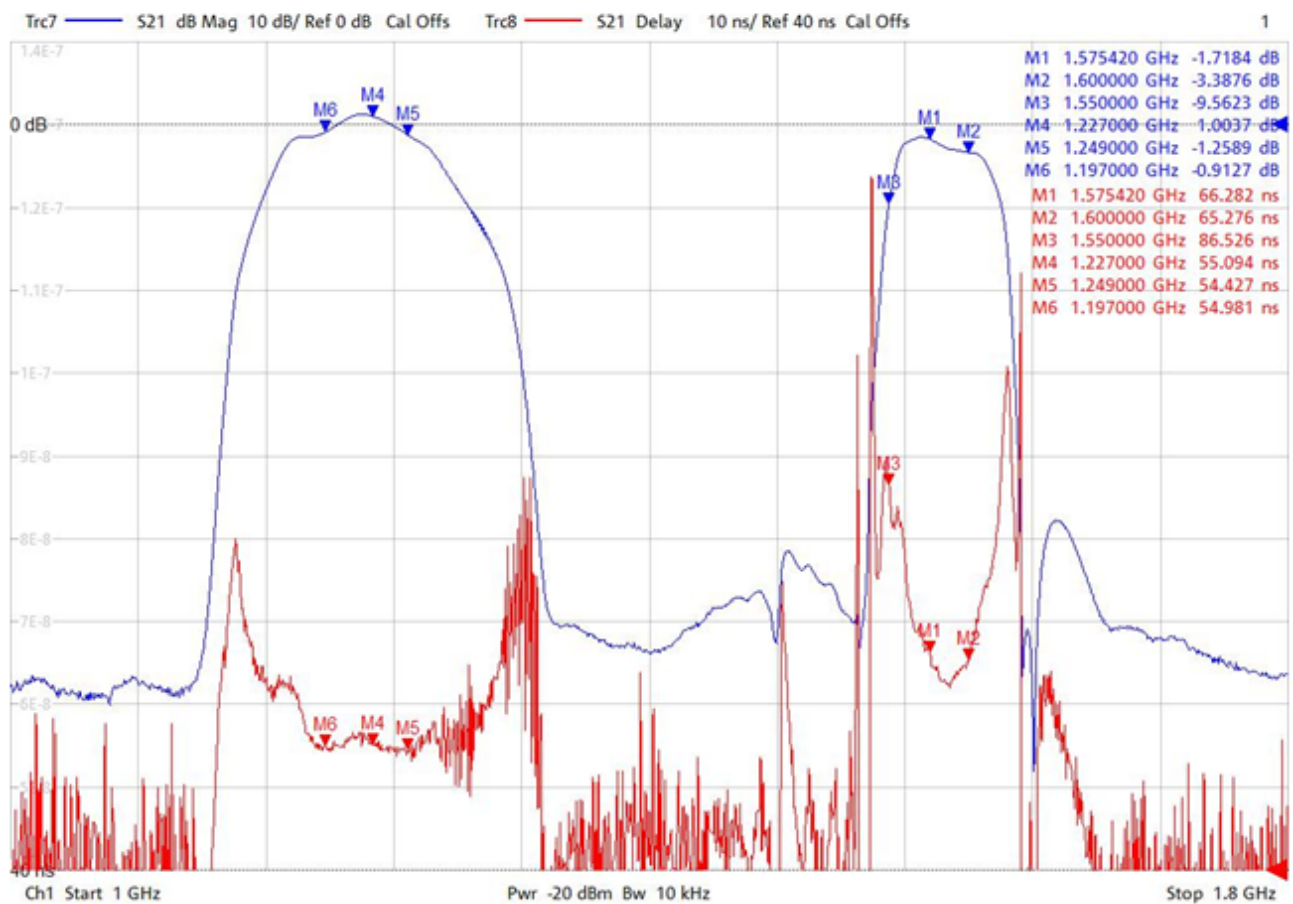

Figure 58: Low cost L1/L2 antenna Band characteristics

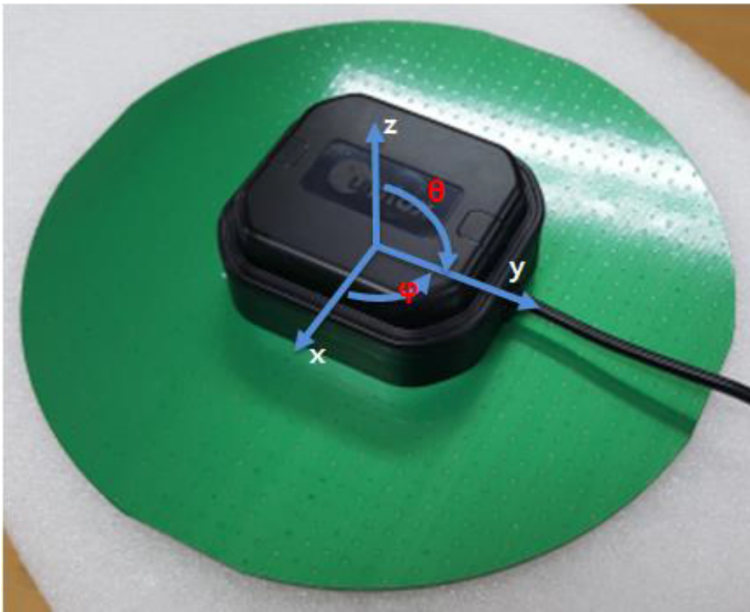

Figure 59: u-blox low cost L1/L2 RTK antenna



Figure 60: Taoglas active L1/L2 antenna

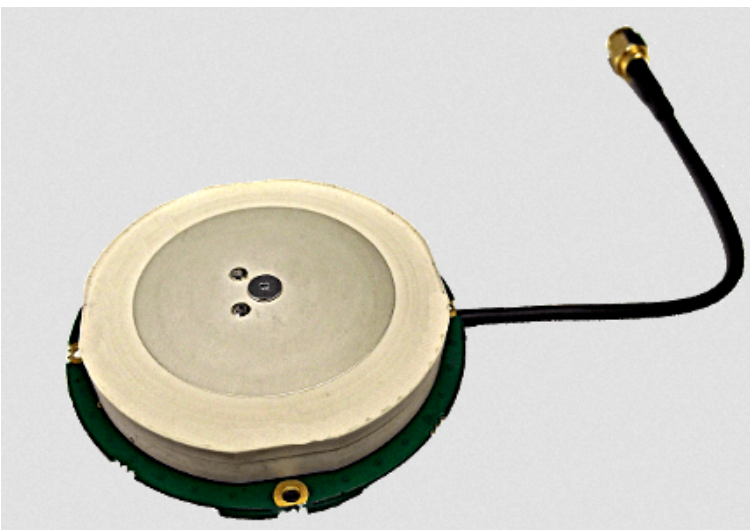

Figure 61: Tallysman active L1/L2 antenna



Figure 62: Harada active L1/L2 antenna



Figure 63: Antcom active L1/L2 antenna

There are antenna that can be used that do not require a ground plane such as helical antenna. This is ideal for drone applications or small form factor applications.



Figure 64: Harxon helix active L1/L2 antenna

8.5 ZED-F9P minimal design

The minimal electrical circuit for ZED-F9P operation using the UART1 interface is shown below

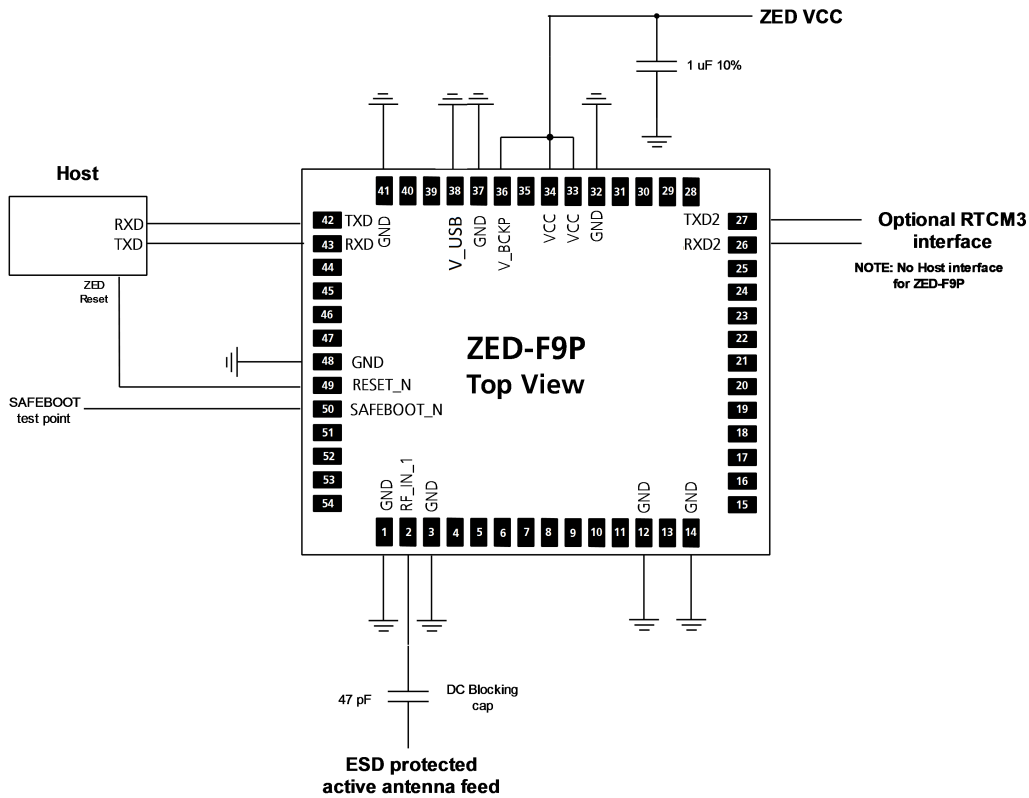

Figure 65: Minimal ZED-F9P design



The LGA center ground pads under the module must be soldered and connected to ground.

The UART1 interface that is connected to the Host will usually also have the RTCM messages required for RTK operation transferred on it. The optional UART2 interface can only be used for RTCM/NMEA messages and has no Host interface capabilities.

It is important to connect V_USB to ground if USB is not used.

8.6 ZED-F9P antenna bias

Active antennas have an integrated low-noise amplifier. Active antennas require a power supply that will contribute to the total GNSS system power consumption budget with additional 5 to 20 mA typically. If the customers do not want to make use of the Antenna Supervisor function and the supply voltage of the ZED-F9P module matches the supply voltage of the antenna (e.g. 3.0 V), they can use the filtered supply voltage VCC_RF output to supply the antenna. However a 10 Ω current limiting resistor is required to prevent against short circuits destroying the BIAS-T inductor.

The bias-t inductor must be chosen for multi-band operation a value of 120 nH 5% is recommended.

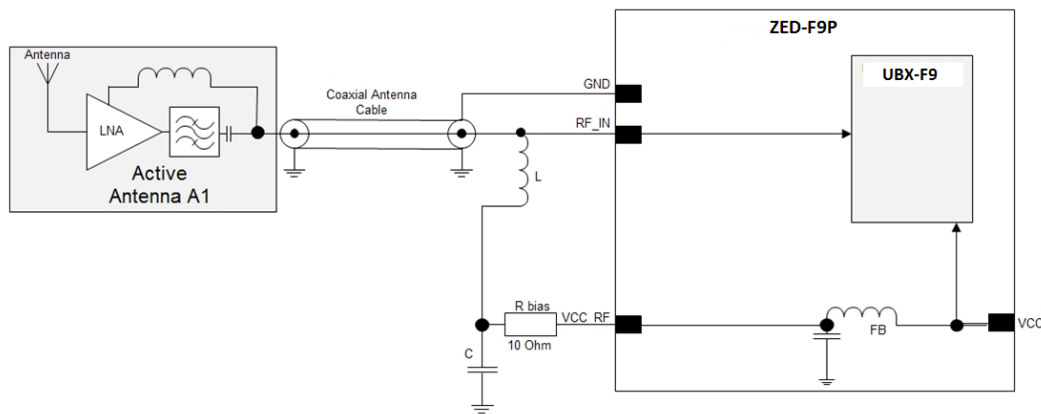

Figure 66: ZED-F9P VCC_RF antenna bias

If the VCC_RF voltage does not match with the supply voltage of the active antenna, use a filtered external supply.

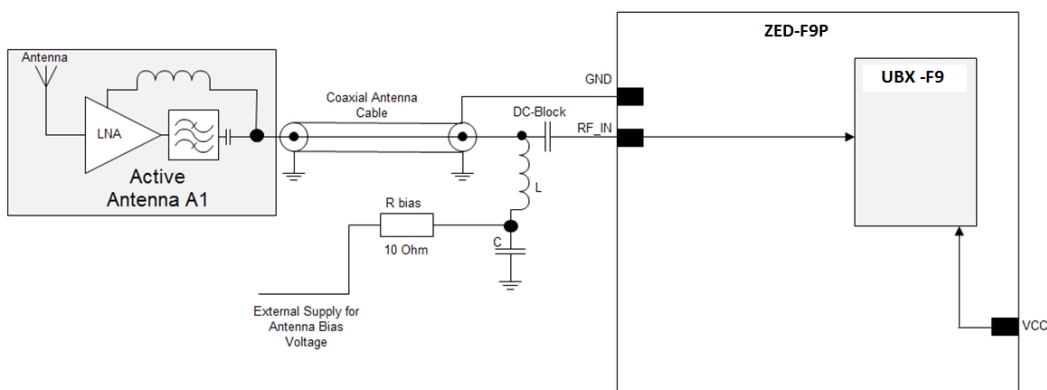

Figure 67: ZED-F9P external voltage antenna bias

The recommended circuit design for the active antenna bias using an external voltage and current limiting circuit is shown below. This also includes ESD protection that must be implemented.

RF INPUT FOR ZED-F9P AND ANTENNA BIAS

NOTE:

BIAS-CIRCUITRY LIMITS THE CURRENT TO ~70MA

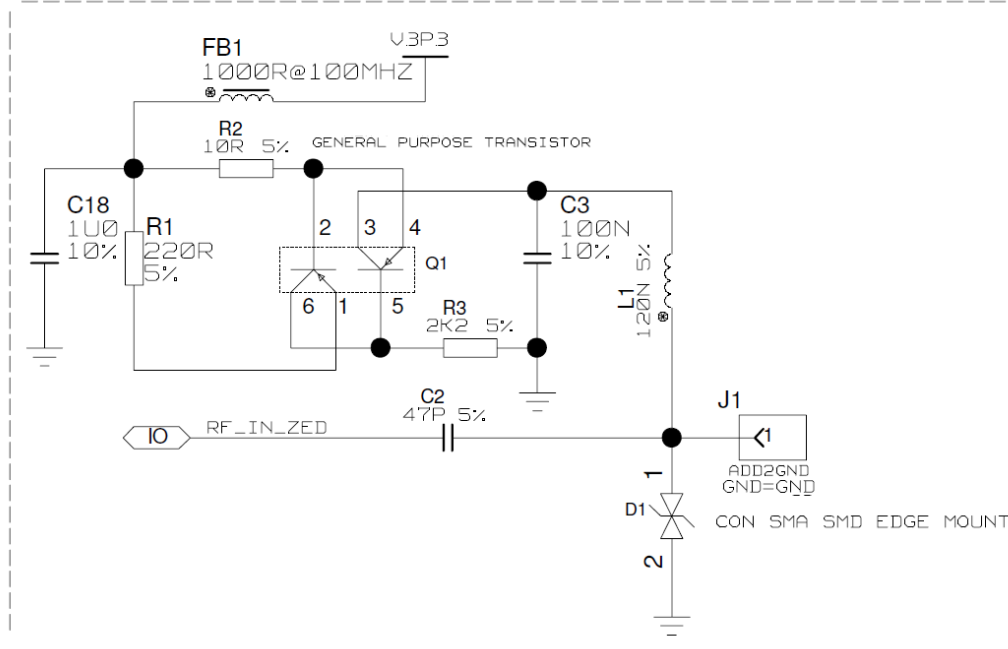

Figure 68: ZED-F9P antenna bias

L1: MURATA LQW15A 0402 120N 5% 0.11A -55/+125C

D1: TYCO, 0.25PF, PESD0402-140 -55/+125C

 C2: MURATA GRM0335C1H470JA01 47pF $\pm 5\%$ 50Vdc COG(EIA) 0 \pm 30ppm -55 to 125C

C3: MURATA GRM155R61A104KA01 CER X5R 0402 100N 10% 10V

8.7 Layout

This section details layout and placement requirements of the ZED-F9P high precision receiver.

8.7.1 Placement

GNSS signals at the surface of the Earth are about 19 dB below the thermal noise floor. A very important factor in achieving maximum GNSS performance is the placement of the receiver on the PCB. The Placement used may affect RF signal loss from antenna to receiver input and enable interference into the sensitive parts of the receiver chain, including the antenna itself. When defining a GNSS receiver layout, the placement of the antenna with respect to the receiver, as well as grounding, shielding and interference from other digital devices are crucial issues and need to be considered very carefully.

Signal loss on the RF connection from antenna to receiver input must be minimized as much as possible. Hence, the connection to the antenna must be kept as short as possible.

Make sure that RF critical circuits are clearly separated from any other digital circuits on the system board. To achieve this, position the receiver digital part towards your digital section of the system PCB and have the RF section and antenna placed as far as possible away from the other digital circuits on the board.

A proper GND concept shall be followed: The RF section should not be subject to noisy digital supply currents running through its GND plane.

Care must also be exercised with placing the receiver in proximity to circuitry that can emit heat. The RF part of the receiver is very sensitive to temperature and sudden changes can have an adverse impact on performance.



Attention :The TCXO of a GNSS receiver is a temperature sensitive device. Avoid high temperature drift and air convection.

8.7.2 Package footprint, copper and solder mask

Copper and solder mask dimensioning recommendations for the ZED-F9P high precision receiver packages are provided in this section. For all packages, the yellow color shows the copper (etch) dimensions, the green color shows the solder mask opening dimensions and the red circles indicate vias. Some PCB manufacturers prefer to adapt solder mask openings to their process tolerances. The recommendations given in this section provide the nominal openings not including such additional tolerances.

Paste mask recommendations are not provided as these are usually specifically related to the solder paste in use as well as the particular re-flow process.



The module edge pads are 0.8 mm x 1.5 mm. Solder mask for the same pad is 0.9 mm x 1.6 mm. Paste mask for the same pad is 0.75 mm x 1.55 mm. Implement a pad size on your PCB as a copper pad size of 0.8 mm x 1.5 mm. The same dimensions as the pads on the module.

Units below are in mm.

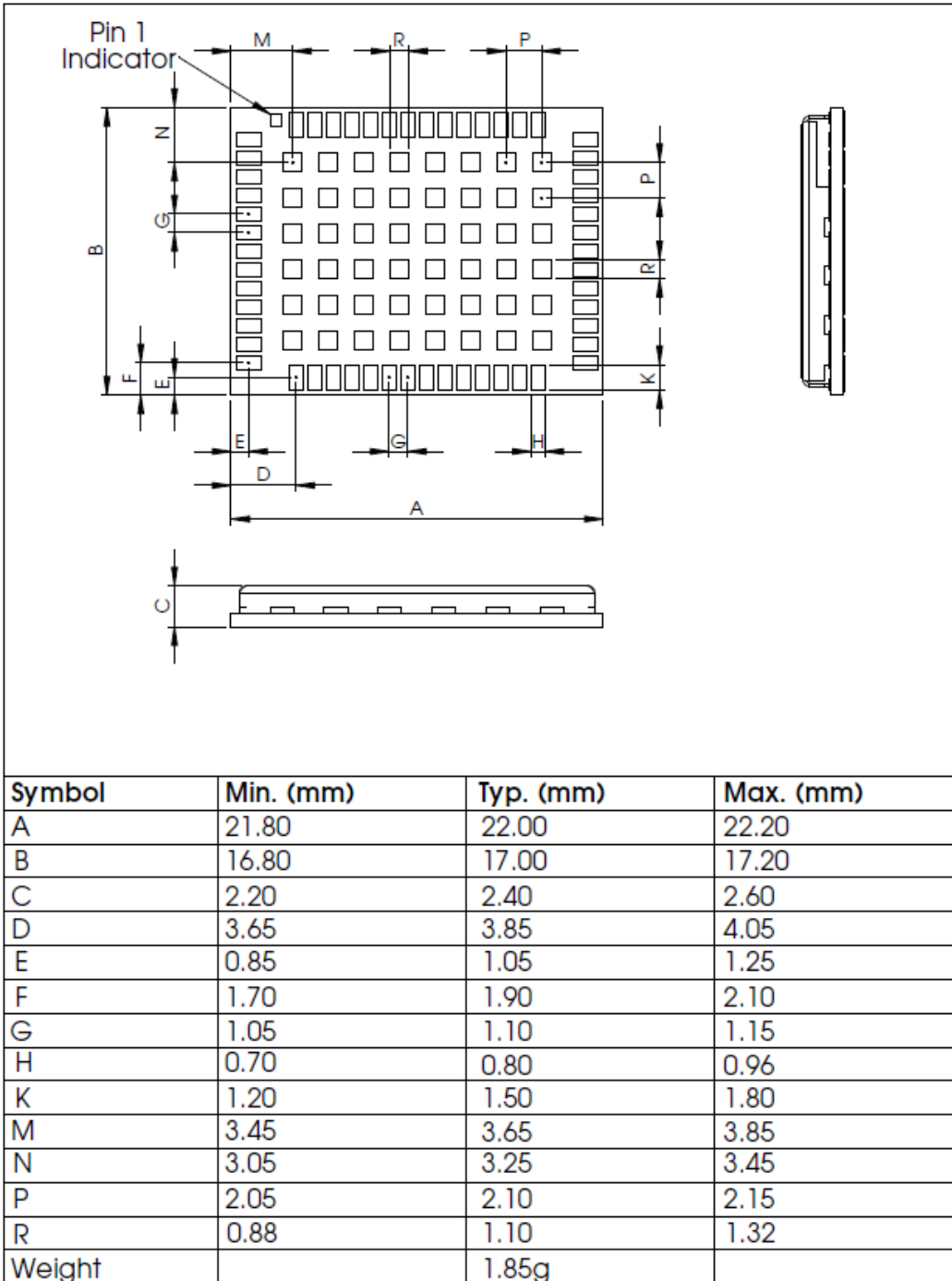
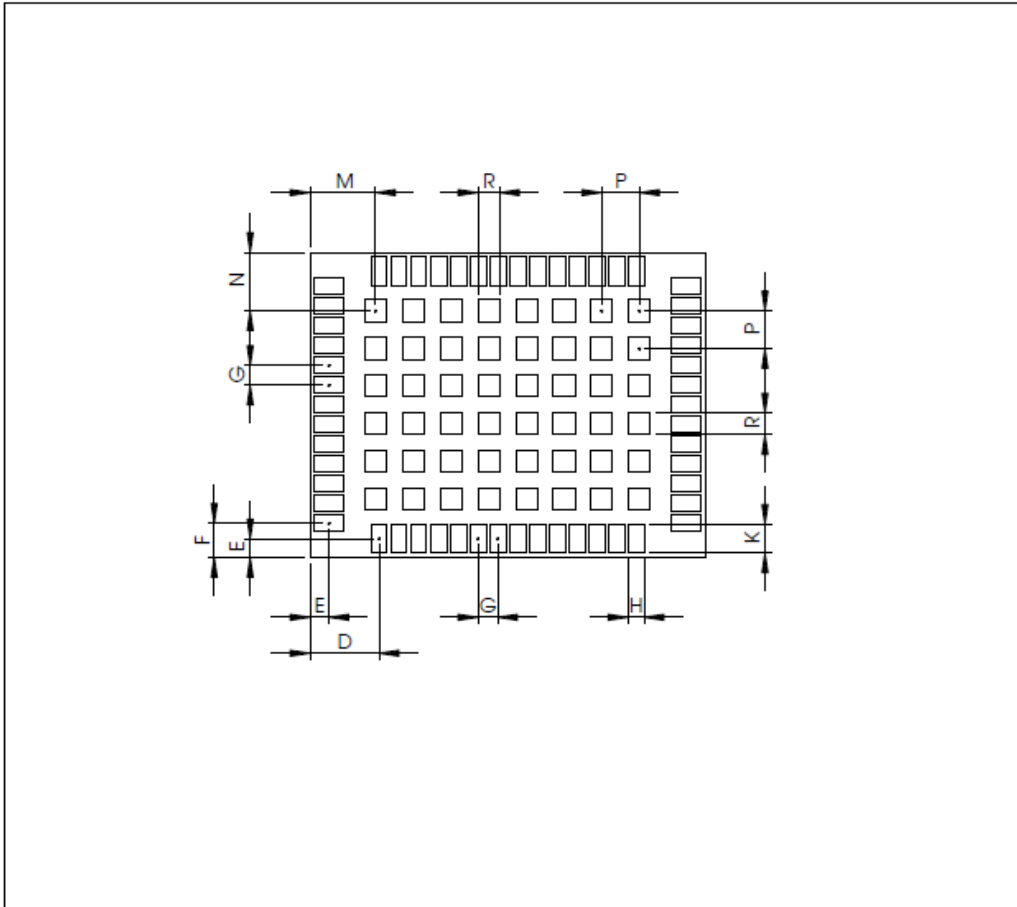

Figure 69: ZED-F9P LGA mechanical dimensions

Soldermask

Symbol	Min. (mm)	Typ. (mm)	Max. (mm)
D		3.85	
E		1.05	
F		1.90	
G		1.10	
H	0.80	0.90	1.00
K	1.50	1.60	1.70
M		3.65	
N		3.25	
P		2.10	
R	1.10	1.20	1.30

Figure 70: ZED-F9P LGA Solder mask dimensions

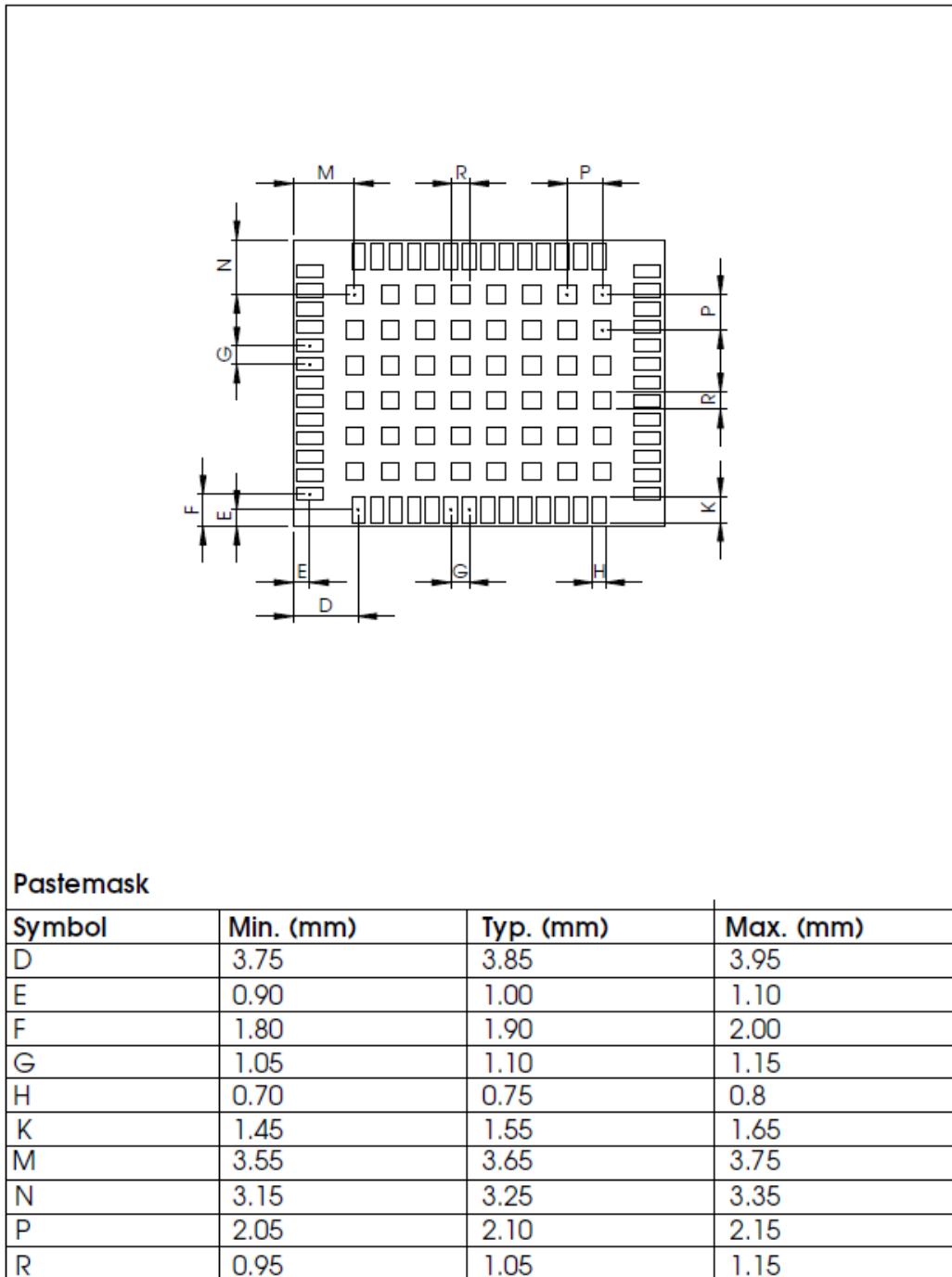

Figure 71: ZED-F9P LGA Paste mask dimensions

8.8 Layout guidance

Presented layout guidance reduces the risk of performance issues at design level with the ZED-F9P high precision receiver.

8.8.1 RF In trace

The RF In trace has to work in the combined GNSS L1 + L2 signal band.

For FR-4 PCB material with a Dielectric permativity of for example 4.7 we can calculate the trace width at 1575 MHz for 50 Ω impedance.

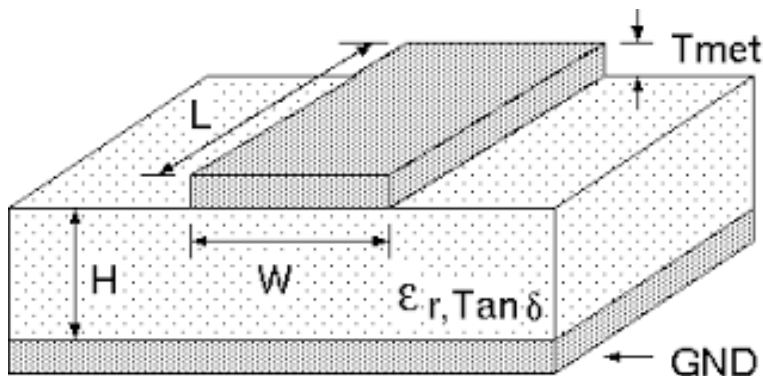

Figure 72: Microstrip trace width

A grounded co-planar RF trace is recommended as it provides the maximum shielding from noise with adequate vias to the ground layer.

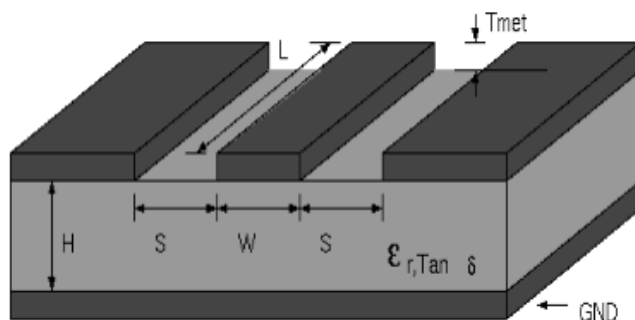

Figure 73: Grounded coplanar RF trace

Make sure that RF critical circuits are clearly separated from any other digital circuits on the system board. To achieve this, position the receiver digital part towards your digital section of the system PCB and have the RF section and antenna placed as far as possible away from the other digital circuits on the board.

A proper GND concept shall be followed: The RF section should not be subject to noisy digital supply currents running through its GND plane.

Care must also be exercised with placing the receiver in proximity to circuitry that can emit heat. The RF part of the receiver is very sensitive to temperature and sudden changes can have an adverse impact on performance.

⚠ Attention :The TCXO of a GNSS receiver is a temperature sensitive device. Avoid high temperature drift and air convection.

The RF trace must be shielded by vias to Ground along the entire length of the trace and the ZED-F9P high precision receiver RF_IN pad should be surrounded by vias as shown in the figure below.

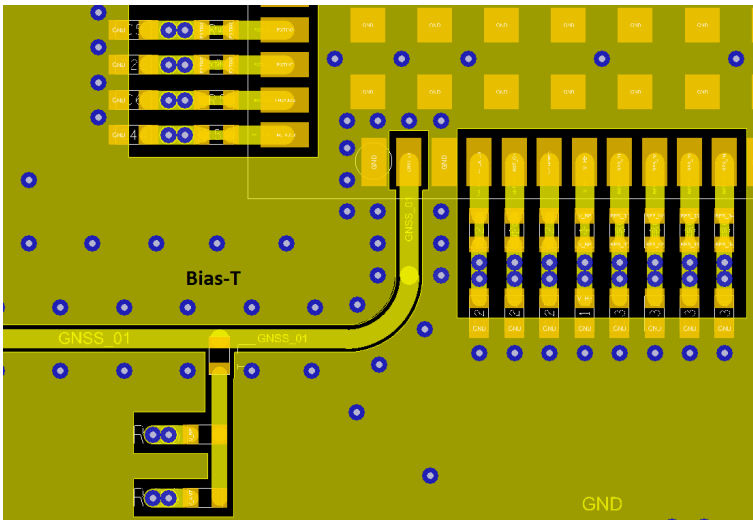

Figure 74: RF input trace

The RF in trace on the Top layer should be referenced to a suitable ground layer.

8.8.2 Vias for the ground pads

The ground pads under the ZED-F9P high precision receiver need to be grounded with vias to the lower ground layer of the PCB. A solid ground layer fill on the Top layer of the PCB is recommended. This is shown in the figure below.

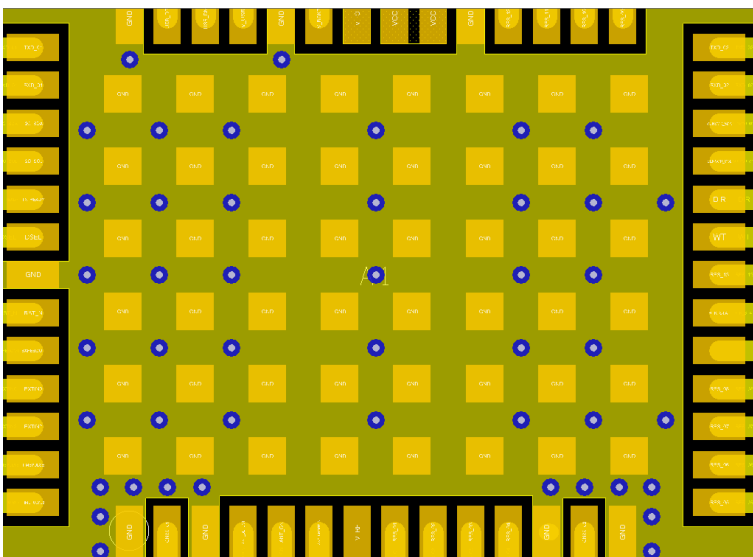

Figure 75: Top layer fill and vias

8.8.3 VCC pads

The VCC pads for the ZED-F9P high precision receiver need to be as low an impedance as possible with large vias to the lower Power layer of the PCB. The VCC pads need a large combined pad and the de-coupling capacitors must be placed as close as possible. This is shown in the figure below.

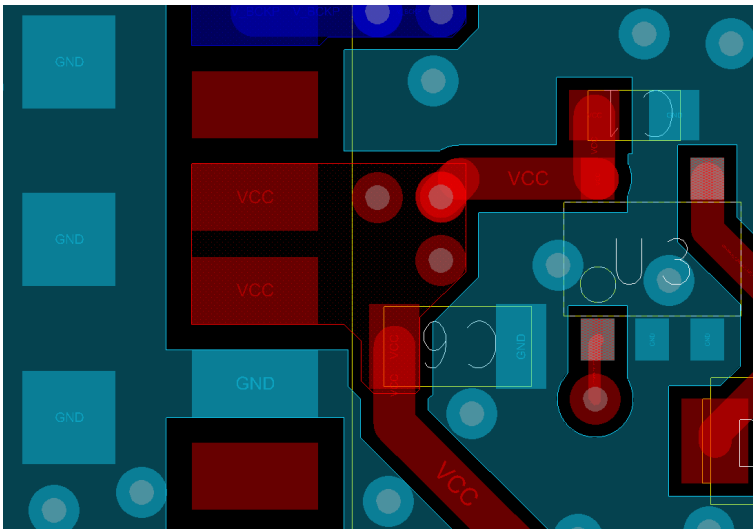

Figure 76: VCC pads

8.9 Design in checklist

8.9.1 General considerations

Check power supply requirements and schematic:

- Is the power supply voltage within the specified range?
- If USB is not used connect the V_USB pin to ground.
- If USB is used is is connected to receiver VCC?
- For USB devices: Is the voltage V_USB voltage within the specified range? Do you have a Bus or Self powered setup?
- If USB is used, is there a 1 uF and a 100 nF capacitor right near the V_USB pin? This is just for the V_USB pin.
- Is there a 1 uF cap right next to the module VCC pin.
- Compare the peak current consumption of the ZED-F9P GNSS module with the specification of your power supply.
- GNSS receivers require a stable power supply. Avoid series resistance (less than 0.2 Ω) in your power supply line (the line to VCC) to minimize the voltage ripple on VCC.
- All I/O (including UART) must not be pulled high before power ON or when VCC is removed with battery back up supplied.
- Any pull ups must be tied to module VCC to ensure they are at the correct state on power ON and OFF.
- Allow all I/O to Float/High impedance when VCC is not applied. See "Interfaces" section.

8.9.2 Back up battery

Check back up supply requirements and schematic:

- For achieving a minimal Time To First Fix (TTFF) after a power down (warm starts, hot starts), make sure to connect a backup battery to V_BCKP
- Verify your battery back up supply can provide the battery back up current specified in the ZED-F9P datasheet
- Allow all I/O including UART and other interfaces to Float/High impedance in HW backup mode (Battery Back-up connected with VCC removed).

8.9.3 Antenna/ RF input

Check RF input requirements and schematic:

- With the ZED-F9P GNSS module, an active antenna meeting our antenna requirements is mandatory is to achieve the performance values as written in the ZED-F9P datasheet.
- Implementing your own antenna design with a suitable antenna element (stacked patch or helix) and the required RF components is complex and should not be carried out unless under the strict guidance of the antenna supplier to meet our requirements. The risk in not meeting the required RTK performance is a factor.
- An OEM active antenna module that meets our requirements should be used if there is a need to integrate the antenna.
- The total maximum noise figure including external LNA (or the LNA in the active antenna) should be around 2 dB.
- Ensure active antenna gain is ideally between 30 - 40 dB gain.
- Make sure the antenna is not placed close to noisy parts of the circuitry and not facing noisy parts. (e.g. micro-controller, display, etc.)
- For RTK operation good signals levels above 40 CNO average are required. There is a requirement on the minimum number and type of GNSS satellites being received in a typical environment to achieve fixed RTK performance: Signals above 35 CNO (minimum) for a minimum of 6 GPS satellites. The same is true for any single system that is enabled (Beidou, GLONASS). The same is true if a multi constellation configuration is used. A single system being received must have 6 satellites at the minimum signal level and quality to achieve RTK Fixed status.
- If a patch type antenna used an antenna ground plane minimum 100 - 150 mm in diameter are required.
- Ensure antenna is L1 and L2 band specified.
- Ensure antenna element gain is between 2 - 3 dBic typical for L1 and L2 bands.
- Ensure the group delay variation including active antenna is 10 ns max @ each GNSS system bandwidth. Note: Inter-signal requirement 50 ns max.
- ESD protection on the RF input is mandatory.
- Bias-t inductor must be L1 and L2 band frequency selected. 120 nH typical.
- Ensure RF trace is tuned for 50 Ω at 1575 MHz to ensure L1 and L2 band width.

8.9.4 ZED-F9P ground pads

Ensure the ground pads under the module are connected to ground.

8.9.5 Schematic design-in.

For a minimal design with the ZED-F9P GNSS modules, the following functions and pins need to be considered:

- Connect the power supply to VCC and V_BCKP.
- V_USB: If USB is used connect V_USB to receiver VCC.
- If USB is not used connect V_USB to ground.
- Ensure an optimal ground connection to all ground pins of the ZED-F9P GNSS modules.
- Choose the required serial communication interfaces (UART, USB, SPI or DDC) and connect the appropriate pins to your application
- If you need hot or warm start in your application, connect a Backup Battery to V_BCKP.
- Antenna bias is required, see ZED-F9P antenna bias section.

8.9.6 Pin assignment

Pin No	Name	I/O	Description	Remark
1	GND	-	Ground	Outer ground pin

Pin No	Name	I/O	Description	Remark
2	RF_IN_1	I	RF input	ESD protection required, active antenna, L1/L2 band. Bias-t needed.
3	GND	-	Ground	Outer ground pin
4	ANT_DETECT	I	Active antenna detect	Leave open if not used. Add zero Ω jumper if used.
5	ANT_OFF	O	External LNA disable	Leave open if not used
6	ANT_SHORT_N	I	Active antenna short detect	Leave open if not used
7	VCC_RF	O	Voltage for external LNA	Leave open if not used
8	Reserved	-	Reserved	Do not connect
9	Reserved	-	Reserved	Do not connect
10	Reserved	-	Reserved	Do not connect
11	Reserved	-	Reserved	Do not connect
12	GND	-	Ground	Outer ground pin
13	Reserved	-	Reserved	Do not connect
14	GND	-	Ground	Outer ground pin
15	Reserved	-	Reserved	Do not connect
16	Reserved	-	Reserved	Do not connect
17	Reserved	-	Reserved	Do not connect
18	Reserved	-	Reserved	Do not connect
19	GEOFENCE_STAT	O	Geofence status, user defined	Leave open if not used
20	RTK_STAT	O	RTK status 0 – Fixed, blinking – receiving RTCM data, 1 – no corrections	Leave open if not used
21	Reserved	-	Reserved	Do not connect
22	Reserved	-	Reserved	Do not connect
23	Reserved	-	Reserved	Do not connect
24	Reserved	-	Reserved	Do not connect
25	Reserved	-	Reserved	Do not connect
26	RXD2	I	Correction UART input	Leave open if not used
27	TXD2	O	Correction UART output	Leave open if not used
28	Reserved	-	Reserved	Do not connect
29	Reserved	-	Reserved	Do not connect
30	Reserved	-	Reserved	Do not connect
31	Reserved	-	Reserved	Do not connect
32	GND	-	Ground	Outer ground pin
33	VCC	I	Voltage supply	Low impedance supply. Less than 0.2 Ω .
34	VCC	I	Voltage supply	Low impedance supply. Less than 0.2 Ω
35	Reserved	-	Reserved	Do not connect
36	V_BCKUP	I	Backup supply voltage	Connect to VCC if not used. If used isolate I/O in hardware backup mode. Check current specification.
37	GND	-	Ground	Outer ground pin
38	V_USB	I	USB supply	Connect to VCC if used. If USB is not used connect to ground.
39	USB_DM	I/O	USB data	Leave open if not used

Pin No	Name	I/O	Description	Remark
40	USB_DP	I/O	USB data	Leave open if not used
41	GND	-	Ground	Outer ground pin
42	TXD / SPI MISO	O	Host UART output if D_SEL = 1 (or open). SPI MISO if D_SEL = 0	At least UART1 should be connected to host.
43	RXD / SPI MOSI	I	Host UART input if D_SEL = 1 (or open). SPI MOSI if D_SEL = 0	At least UART1 should be connected to host.
44	SDA / SPI_CS_N	I/O	DDC Data if D_SEL = 1 (or open). SPI Chip Select if D_SEL = 0	Leave open if not used
45	SCL / SPI_CLK	I/O	DDC Clock if D_SEL = 1 (or open). SPI Clock if D_SEL = 0	Leave open if not used
46	TX_READY	O	TX_Buffer full and ready for TX of data	I2C bytes ready for transmission indicator if needed. Leave open if not used
47	D_SEL	I	Interface select for pins 42-45	Leave open if not used. UART1 will be default
48	GND	-	Ground	Outer ground pin
49	RESET_N	I	RESET_N	Leave open if not used. Not a POR function. Will cold start receiver
50	SAFEBOOT_N	I	SAFEBOOT_N (for future service, updates and reconfiguration, leave OPEN)	Leave open if not used, provide test point for future use
51	EXTINT	I	External Interrupt Pin	Leave open if not used
52	Reserved	-	Reserved	Do not connect
53	TIMEPULSE	O	Time pulse	Leave open if not used
54	Reserved	-	Reserved	Do not connect

Table 24: ZED-F9P pin assignment

Connect all inner ground pins to top ground layer and use ground vias.

8.9.7 Layout design-in checklist

- Is the ZED-F9P placed away from any heat source?
- Is the ZED-F9P placed away from any air cooling source?
- Is the ZED-F9P shielded by a cover/case to prevent the effects of air currents and rapid environmental temperature changes?
- Is the ZED-F9P placed as recommended in the Layout and Layout Guidance section?
- Assure a low serial resistance on the VCC power supply line (choose a line width > 400 um).
- Keep the power supply line as short as possible.
- Add a ground plane underneath the GNSS module to reduce interference. This is especially important for the RF input line.
- For improved shielding, add as many vias as possible around the micro strip/coplanar waveguide, around the serial communication lines, underneath the GNSS module, etc.

9 Product handling

9.1 Soldering

Soldering Paste

Use of “No Clean” soldering paste is highly recommended, as it does not require cleaning after the soldering process has taken place. The paste listed in the example below meets these criteria.

- Soldering Paste: OM338 SAC405 / Nr.143714 (Cookson Electronics)
- Alloy specification: Sn 95.5/ Ag 4/ Cu 0.5 (95.5% Tin/ 4% Silver/ 0.5% Copper)
- Melting Temperature: 217 °C
- Stencil Thickness: The exact geometry, distances, stencil thicknesses and solder paste volumes must be adapted to the specific production processes (e.g. soldering) of the customer.

Reflow soldering

A convection type-soldering oven is highly recommended over the infrared type radiation oven. Convection heated ovens allow precise control of the temperature, and all parts will heat up evenly, regardless of material properties, thickness of components and surface color.

As a reference, see the “IPC-7530 Guidelines for temperature profiling for mass soldering (reflow and wave) processes”, published in 2001.

Preheat phase

During the initial heating of component leads and balls, residual humidity will be dried out. Note that this preheat phase will not replace prior baking procedures.

- Temperature rise rate: max. 3 °C/s. If the temperature rise is too rapid in the preheat phase it may cause excessive slumping.
- Time: 60 – 120 s. If the preheat is insufficient, rather large solder balls tend to be generated. Conversely, if performed excessively, fine balls and large balls will be generated in clusters.
- End Temperature: 150 – 200 °C. If the temperature is too low, non-melting tends to be caused in areas containing large heat capacity.

Heating - Reflow Phase

The temperature rises above the liquidus temperature of 217°C. Avoid a sudden rise in temperature as the slump of the paste could become worse.

- Limit time above 217 °C liquidus temperature: 40 – 60 s
- Peak reflow temperature: 245 °C

Cooling Phase

A controlled cooling avoids negative metallurgical effects (solder becomes more brittle) of the solder and possible mechanical tensions in the products. Controlled cooling helps to achieve bright solder fillets with a good shape and low contact angle.

- Temperature fall rate: max 4 °C/s



To avoid falling off, the modules should be placed on the topside of the motherboard during soldering

The final soldering temperature chosen at the factory depends on additional external factors like choice of soldering paste, size, thickness and properties of the base board, etc. Exceeding the maximum soldering temperature in the recommended soldering profile may permanently damage the module.

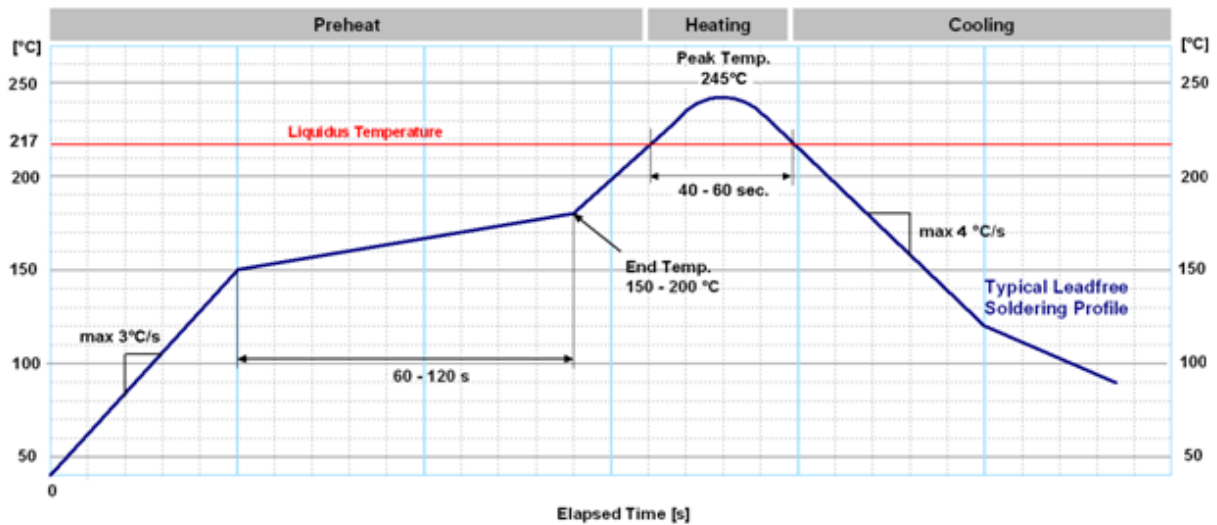

Figure 77: Soldering Profile

Modules **must not** be soldered with a damp heat process.

Optical inspection

After soldering the module, consider an optical inspection step.

Cleaning

No cleaning with water, solvent, ultrasonic cleaner should be carried out:

- Cleaning with water will lead to capillary effects where water is absorbed in the gap between the baseboard and the module. The combination of residues of soldering flux and encapsulated water leads to short circuits or resistor-like interconnections between neighboring pads.
- Cleaning with alcohol or other organic solvents can result in soldering flux residues flooding into the two housings, areas that are not accessible for post-wash inspections. The solvent will also damage the sticker and the ink-jet printed text.
- Ultrasonic cleaning will permanently damage the module, in particular the quartz oscillators.

The best approach is to use a “No Clean” soldering paste and eliminate the cleaning step after the soldering.

Repeated reflow soldering

Only single reflow soldering processes are recommended for boards populated with modules. Modules should not be submitted to two reflow cycles on a board populated with components on both sides in order to avoid upside down orientation during the second reflow cycle. In this case, the module should always be placed on that side of the board, which is submitted into the last reflow cycle. The reason for this (besides others) is the risk of the module falling off due to the significantly higher weight in relation to other components.

Two reflow cycles can be considered by excluding the above described upside down scenario and taking into account the rework conditions described in this section.

Repeated reflow soldering processes and soldering the module upside down are not recommended.

Wave soldering

Base boards with combined through-hole technology (THT) components and surface-mount technology (SMT) devices require wave soldering to solder the THT components. Only a single wave soldering process is encouraged for boards populated with modules.

Rework

We do not recommend using a hot air gun because this is an uncontrolled process and might damage the module.

 **Attention** : Use of a hot air gun can lead to overheating and severely damage the module. Always avoid overheating the module.

After the module is removed, clean the pads before re-applying solder paste, placing and reflow soldering a new module.

 **Attention** : Never attempt a rework on the module itself, e.g. replacing individual components. Such actions immediately terminate the warranty.

Conformal coating

Certain applications employ a conformal coating of the PCB using HumiSeal® or other related coating products. These materials affect the HF properties of the GNSS module and it is important to prevent them from flowing into the module. The RF shields do not provide 100% protection for the module from coating liquids with low viscosity; therefore, care is required in applying the coating.

 Conformal Coating of the module will void the warranty.

Casting

If casting is required, use viscose or another type of silicon pottant. The OEM is strongly advised to qualify such processes in combination with the module before implementing this in the production.

 Casting will void the warranty.

Grounding metal covers

Attempts to improve grounding by soldering ground cables, wick or other forms of metal strips directly onto the EMI covers is done at the customer's own risk. The numerous ground pins should be sufficient to provide optimum immunity to interferences and noise.

 u-blox makes no warranty for damages to the module caused by soldering metal cables or any other forms of metal strips directly onto the EMI covers.

Use of ultrasonic processes

Some components on the module are sensitive to Ultrasonic Waves. Use of any Ultrasonic Processes (cleaning, welding etc.) may cause damage to the GNSS Receiver.

 u-blox offers no warranty against damages to the module caused by any Ultrasonic Processes.

9.2 Tapes

The [Figure 78](#) shows the feed direction and illustrates the orientation of the ZED-F9P high precision receivers on the tape:

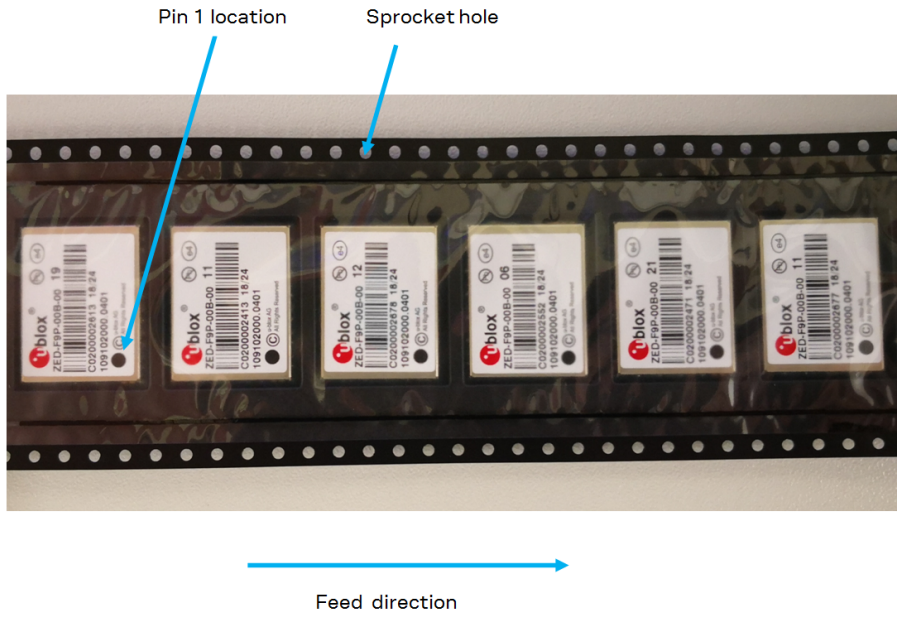
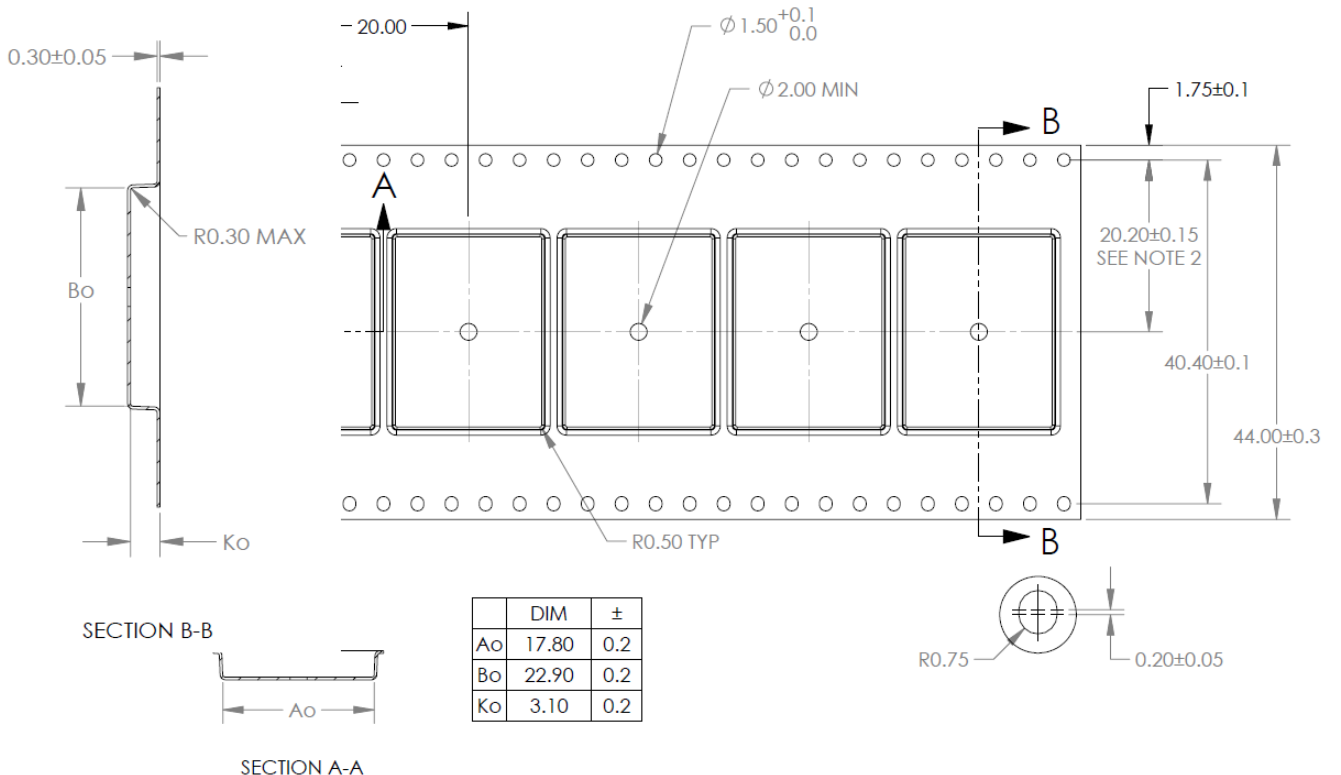

Figure 78: Orientation of ZED-F9P high precision receivers on the tape

The dimensions of the tapes for ZED-F9P high precision receivers are specified in [Figure 79](#) (measurements in mm).



NOTES:

1. 10 SPROCKET HOLE PITCH CUMULATIVE TOLERANCE ± 0.2
2. POCKET POSITION RELATIVE TO SPROCKET HOLE MEASURED AS TRUE POSITION OF POCKET, NOT POCKET HOLE.
3. Ao AND Bo ARE MEASURED ON A PLANE AT A DISTANCE "R" ABOVE THE BOTTOM OF THE POCKET.

Figure 79: ZED-F9P tape dimensions (mm)

9.3 Reels

The ZED-F9P high precision receiver GNSS modules are deliverable in quantities of 250 pieces on a reel. The ZED-F9P high precision receiver receivers are shipped on Reel Type B, as specified in the u-blox Package Information Guide. See the u-blox Package Information Guide [3].

9.4 Moisture Sensitivity Levels

The Moisture Sensitivity Level (MSL) for ZED-F9P high precision receivers is specified in the table below.

Package	MSL Level
LGA	4

Table 25: MSL Level



For MSL standard see IPC/JEDEC J-STD-020, which can be downloaded from www.jedec.org.



For more information regarding moisture sensitivity levels, labeling, storage and drying, see the u-blox Package Information Guide [3].

10 Appendix

10.1 RTCM ITRF Geodetic models

RTK is a differential system where the rover uses the reference datum of the reference station. The International Terrestrial Reference Frame (ITRF) must be obtained from the reference network and then used to transform the rover position output to match the required reference frame. The rover will not output the position in the local receiver WGS84 (based on ITRF2008) datum, it will match the reference receiver (or base) reference frame. The user application will need to do the transformation for use in a mapping application if it does not use the same reference frame. An offset can occur if this is not done.

The list of ITRF reference frame years are below:

- ITRF94
- ITRF96
- ITRF97
- ITRF2000
- ITRF2005
- ITRF2008
- ITRF2014

There are other similar reference systems used by GNSS correction services such as the ETRS89 ([ETRS89](#)).

For example the EUREF network uses the ETRS89 reference frame and this info can be found on the homepage: [EUREF](#).

See the ITRF website for information and an on line transform calculator: [ITRF](#).

Another on-line tool can be found here: [Transformation](#).

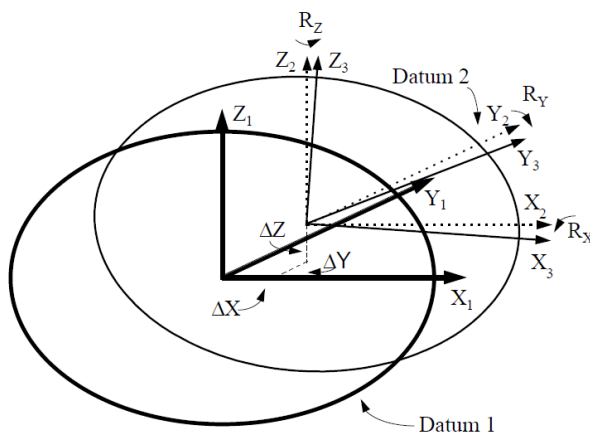

Figure 80: Transforming between two datums

The reference frame of the reference receiver (or base) must be transformed by the user into the required system being used by their application and mapping system. If comparing the rover position with a reference system the same RTCM stream should be used to ensure the reference and rover are outputting the same position. If doing post processing of a reference system its output must be transformed to same ITRF and datum being used by the rover.

For example viewing RTK accurate positions that could be in any ITRF transform reference frame (based on reference receiver (or base) reference frame) on Google Earth: The heights on Google Earth refer to EGM96 and are, therefore, Geoidal heights.

The lat/long are referred to the WGS 84 (ITRF2008) ellipsoid. The result is a visible inaccuracy, the RTK receivers position output will need to be transformed to the Google Earth transform system before it can be realistically used. This is ignoring any local map tile inaccuracies.

Geodetic Coordinate Systems and Ellipsoids:

In practice, the relevant organizations choose to keep their respective frames very close to the International Terrestrial Reference Frame (ITRF), defined and managed by the International Earth Rotation and Reference Systems Service (IERS).

However, because the Earth's tectonic plates and even parts of the Earth's core move, new versions of ITRF are defined every few years, generally with changes of the order of a few millimeters. Consequently, the major GNSS occasionally decide that they need to update their reference frames to be better aligned to the latest ITRF.

So, for example, GPS switched to WGS84 (G1150) in GPS week 1150 (early 2002) based on ITRF2000, while GLONASS switched from PZ90.02 to PZ90.11 at the end of 2013, based on ITRF2008. The net effect of this, is that all the major GNSS use almost the same reference frame, but there are some small (generally sub-cm) differences between them and these differences occasionally change.

In order to produce positions that can be shown on a map, it is necessary to translate between raw coordinates (e.g. x, y, z) and a position relative to the Earth's surface (e.g. latitude, longitude and altitude) and that requires defining the form of ellipsoid that best matches the shape of the Earth.

Historically many different ellipsoid definitions have been used for maps, many of which predate the existence of GNSS and show quite significant differences, leading to discrepancies of as much as 100m in places. Fortunately, most digital maps now use the WGS84 ellipsoid, which is distinct from the WGS84 coordinate system, but defined by the same body.

However for RTK position accuracies now in the cm level the ITRF year for the WGS84 datum used by the mapping system must be known in order to transform the RTK rover position into the correct reference frame.

10.2 Virtual Reference Station

Reaching centimeter-level accuracy of positioning typically requires use of precise dual-frequency carrier phase observations. Furthermore, these observations are usually processed using a differential GNSS (DGNSS) algorithm, such as real time kinematic (RTK) or post-processing (PP).

Regardless of the specific differential algorithm, however, implicit in the process is an assumption that the quality of the reference station data is consistent with the desired level of positioning accuracy. The virtual reference station (VRS) concept can help to satisfy this requirement using a network of reference stations.

As a quick review, a simple DGNSS setup consists of a single reference station from which the raw data (or corrections) are sent to the rover receiver (i.e. the user). The user then forms the carrier phase differences (or corrects their raw data) and performs the data processing using the differential corrections.

In contrast, GNSS reference network architectures often make use of multiple reference stations. This approach allows a more precise modeling of distance-dependent systematic errors principally caused by ionospheric and tropospheric refractions, and satellite orbit errors. More specifically, a GNSS reference network decreases the dependence of the error budget on the distance of nearest antenna.

The picture below shows the network of reference stations used to build up a service covering the whole of Switzerland.

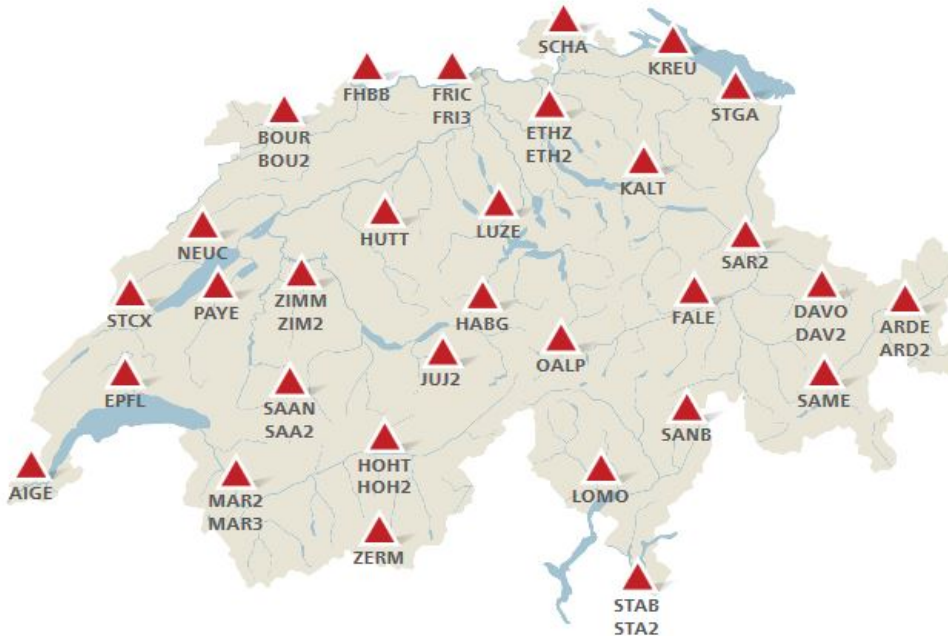

Figure 81: VRS network in Switzerland

The network of receivers is linked to a computation center, and each station contributes its raw data to help create network-wide models of the distance-dependent errors. The computation of errors based on the full network's carrier phase measurements involves, first of all, the resolution of carrier phase ambiguities and requires knowledge of the reference station positions.

The latter is usually determined as part of the network setup.

This generated VRS data is then sent to the user through a wireless connection, often using the Networked Transport of RTCM via Internet Protocol (NTRIP). Finally, just as if the VRS data had come from a physical reference station, the rover receiver uses standard single-baseline algorithms to determine the coordinates of the user's receiver, in real-time kinematic or post-processed modes.

The main purpose of a VRS station is to reduce the baseline distance between the rover and the reference station in order to efficiently remove spatially correlated errors using differential processing, and to incorporate error corrections obtained from the reference stations network.

The Rover receiver must send its own actual position back typically using the NMEA GGA message. Usually if the VRS system does not receive a GGA message it will not provide the RTCM data to the Rover. The VRS concept allows a less dense reference network without accuracy degradation because the multiple reference station network better models the spatially correlated GNSS errors over longer baselines.

As a result the maximum distance between the rover and the nearest reference station can be extended beyond the typical 10~15 kilometers without accuracy degradation of the single reference station case. Another benefit of a VRS is that the reference data are free of site-specific errors such as multipath, because the VRS computation assumes that the virtual station is situated at an ideal location.

11 Related documents

1. ZED-F9P Data sheet, Docu. No. UBX-17051259
2. ZED-F9P Interface Description, Docu. No. UBX-18010853
3. u-blox Package Information Guide, Doc. No. UBX-14001652



For regular updates to u-blox documentation and to receive product change notifications please register on our homepage (<http://www.u-blox.com>).

12 Revision history

Revision	Date	Name	Status / Comments
R01	22-May-2018	ghun	Objective Specification
R02	03-Oct-2018	ghun	Advance Information

Contact

For complete contact information visit us at www.u-blox.com.

u-blox Offices

North, Central and South America

u-blox America, Inc.

Phone: +1 703 483 3180
E-mail: info_us@u-blox.com

Regional Office West Coast

Phone: +1 408 573 3640
E-mail: info_us@u-blox.com

Technical Support

Phone: +1 703 483 3185
E-mail: support_us@u-blox.com

Headquarters Europe, Middle East, Africa

u-blox AG

Phone: +41 44 722 74 44
E-mail: info@u-blox.com
Support: support@u-blox.com

Documentation Feedback

Email: docsupport@u-blox.com

Asia, Australia, Pacific

u-blox Singapore Pte. Ltd.

Phone: +65 6734 3811
E-mail: info_ap@u-blox.com
Support: support_ap@u-blox.com

Regional Office Australia

Phone: +61 2 8448 2016
E-mail: info_anz@u-blox.com
Support: support_ap@u-blox.com

Regional Office China (Beijing)

Phone: +86 10 68 133 545
E-mail: info_cn@u-blox.com
Support: support_cn@u-blox.com

Regional Office China (Chongqing)

Phone: +86 23 6815 1588
E-mail: info_cn@u-blox.com
Support: support_cn@u-blox.com

Regional Office China (Shanghai)

Phone: +86 21 6090 4832
E-mail: info_cn@u-blox.com
Support: support_cn@u-blox.com

Regional Office China (Shenzhen)

Phone: +86 755 8627 1083
E-mail: info_cn@u-blox.com
Support: support_cn@u-blox.com

Regional Office India

Phone: +91 80 4050 9200
E-mail: info_in@u-blox.com
Support: support_in@u-blox.com

Regional Office Japan (Osaka)

Phone: +81 6 6941 3660
E-mail: info_jp@u-blox.com
Support: support_jp@u-blox.com

Regional Office Japan (Tokyo)

Phone: +81 3 5775 3850
E-mail: info_jp@u-blox.com
Support: support_jp@u-blox.com

Regional Office Korea

Phone: +82 2 542 0861
E-mail: info_kr@u-blox.com
Support: support_kr@u-blox.com

Regional Office Taiwan

Phone: +886 2 2657 1090
E-mail: info_tw@u-blox.com
Support: support_tw@u-blox.com