

Voltage Regulator

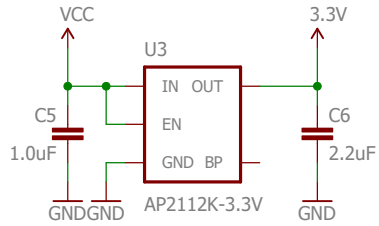

6V max input
600mA output

Battery Backup

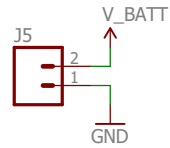

V_BATT : 1.5V - 3.5V

Level Shifting

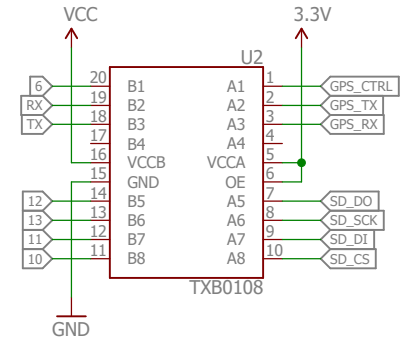

GPS Interface

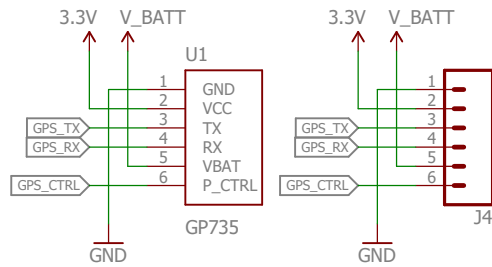

µSD Card Holder

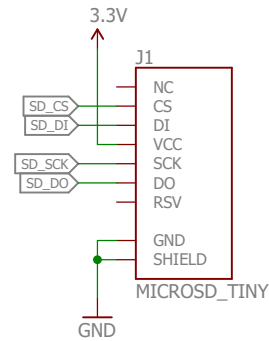

Pro Mini Shield Connections

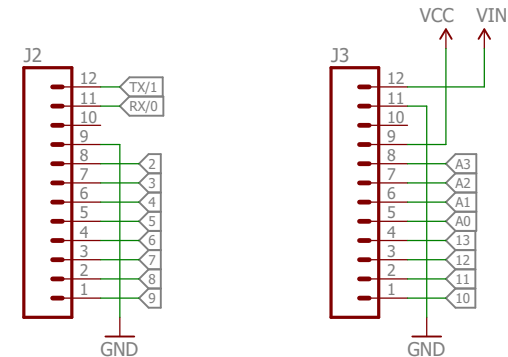

Software/Hardware UART Select

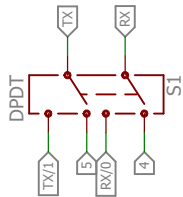

GPS Fix LED

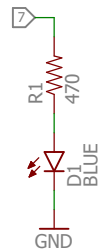

Released under the Creative Commons
Attribution Share-Alike 4.0 License
<https://creativecommons.org/licenses/by-sa/4.0/>



TITLE: SparkFun_Mini_GPS_Shield

Design by: Alex Wende

REV:
v10

Date: 12/2/2016 12:17 PM

Sheet: 1/1