

**SPECIFICATION**

Current Rating:3A  
 Withstand Voltage:1000V AC  
 Contact Resistance:20 Milliohms Max.  
 Insulation Resistance:1000 Megohms Min.  
 Operation Temperature:-40°C~+105°C  
 Housing:PBT(UL94V-0),Black  
 Contact:Brass,Gold Flash Over Nickel  
 RoHS Compliant

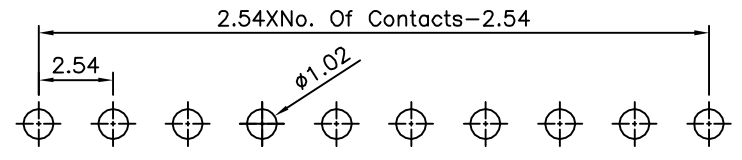

Recommended P.C.B. Layout(Top View)  
 (PCB Board Tolerance±0.05)

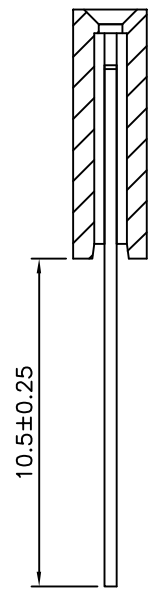
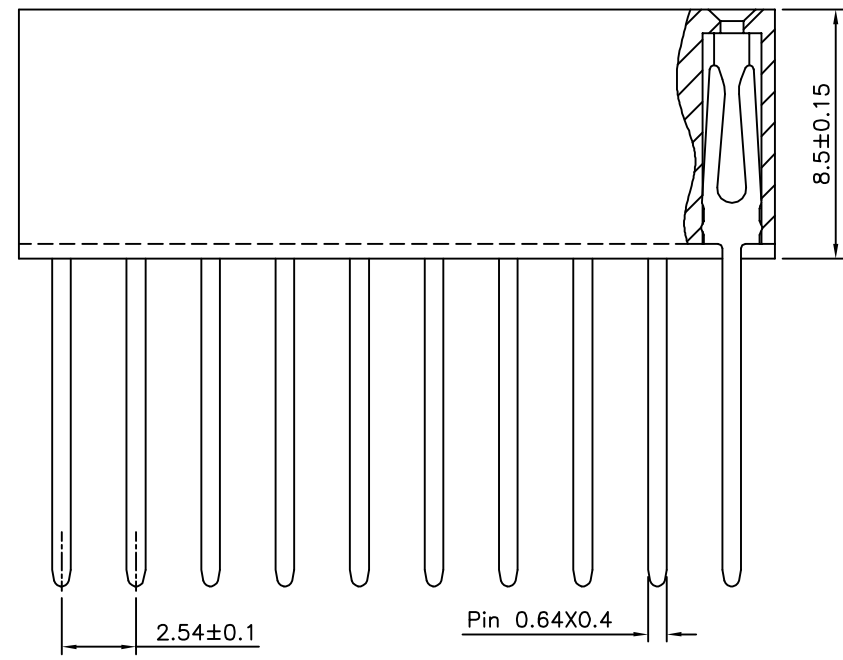
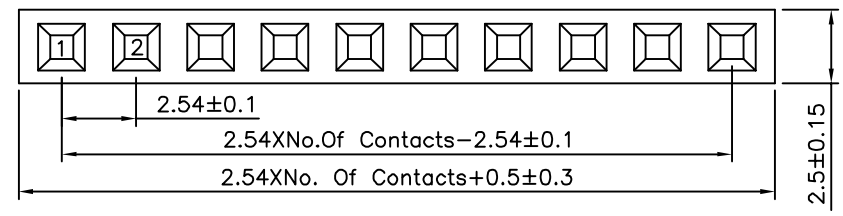

**4UCON** 元化興業股份有限公司  
 4UCON TECHNOLOGY INC.

DRAWING No.		APPROVED BY		UNLESS OTHERWISE SPECIFIED TOLERANCES ARE X. ±0.25 X.* ±2* .X ±0.20 .X* ±1.5* .XX ±0.15 .XX* ±1* .XXX ±0.10 .XXX* ±0.5*
20112		EMILY		
		CHECKED BY		
		HZF		
		DRAWING BY		
		SAN		
SCALE	NONE	REV.	A0	UNIT
				mm

NO.	REV.	REVISIONS	CHK	DATE
△ A0		NEW RELEASE	HZF	10/04/2013