

1	VCC
2	RESET
3	ON/SLEEP
4	PWM0/RISS
5	DIN/CONFIG
6	DOIT
7	RXD X
8	PWM1
9	CD/DOUT_EN/DO8
10	DTR/SLEEP_RQ/D18
11	CTS/DIO7
12	RTS/AD6/DIO6
13	ASSOC/AD5/DIO5
14	RF_TX/AD4/DIO4
15	COORD_SEL/AD3/DIO3
16	AD2/DIO2
17	AD1/DIO1
18	AD0/DIO0
19	NC
20	VREF
21	GND

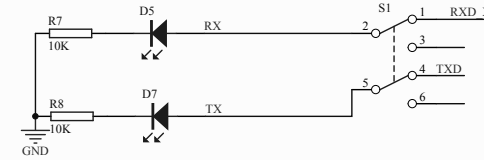

Arduino part XBEE interface  
Other interface Motor drive

DIRA D4  
PWMA PWM2  
DIRB D7  
PWMB PWM3

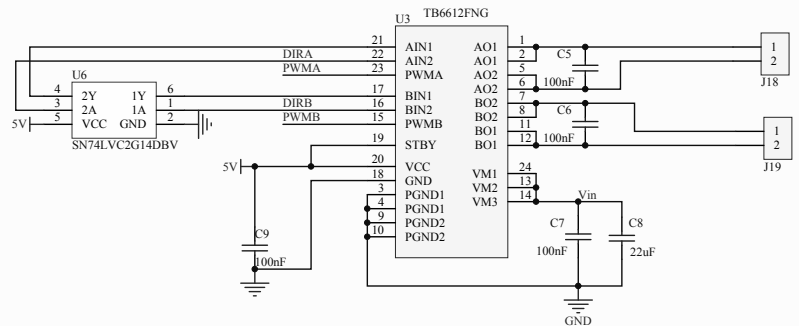
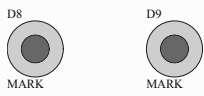
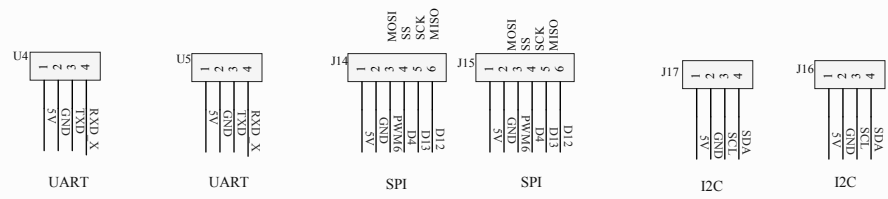

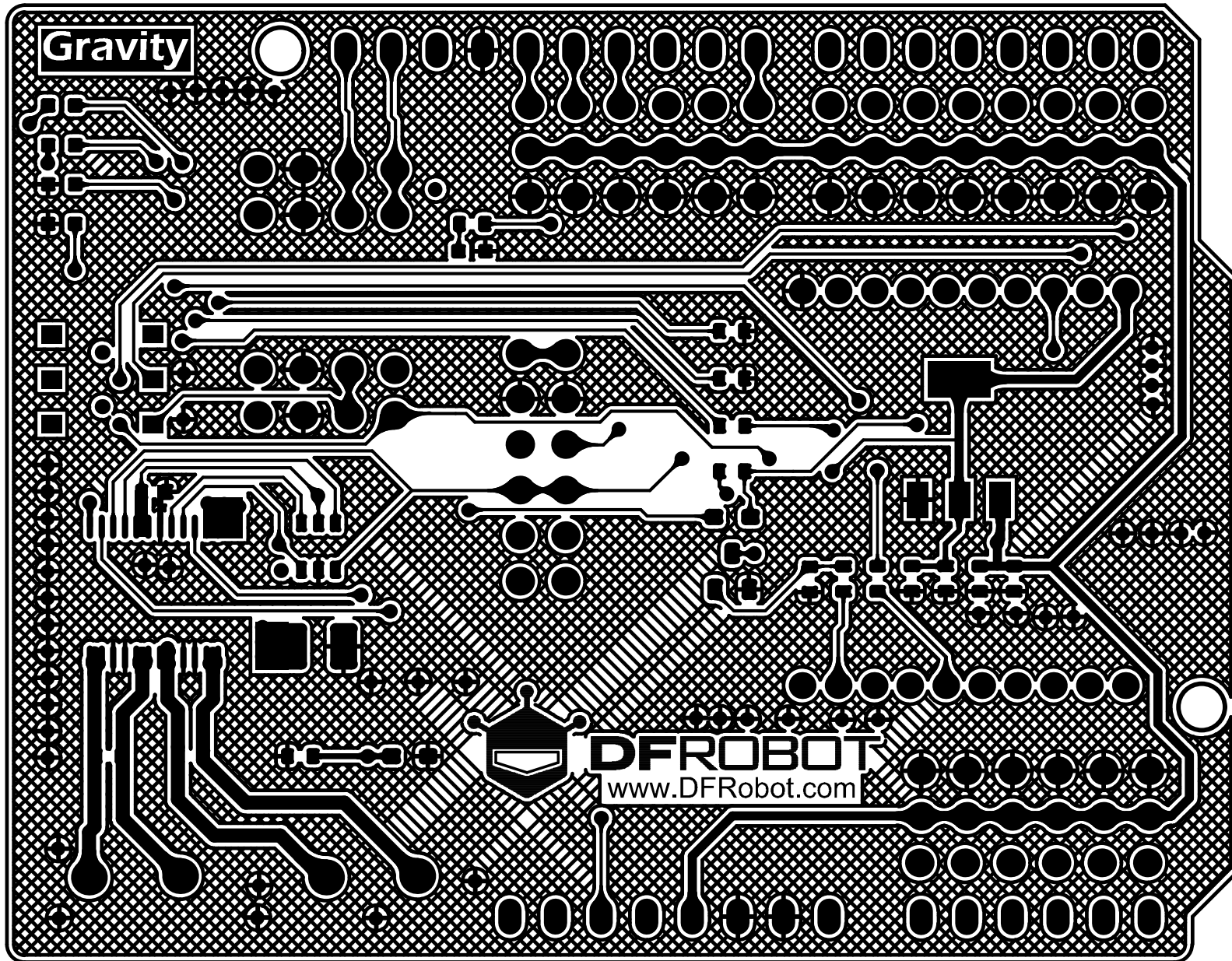

<b>PCB Information</b>	Name: DFR0502[V1.1]	Thickness: 1.6mm
Engineer: DongZi	Top SolderMask: Black	Bottom SolderMask: Black
Date: 20170928	Top Silkscreen: White	Bottom Silkscreen: White

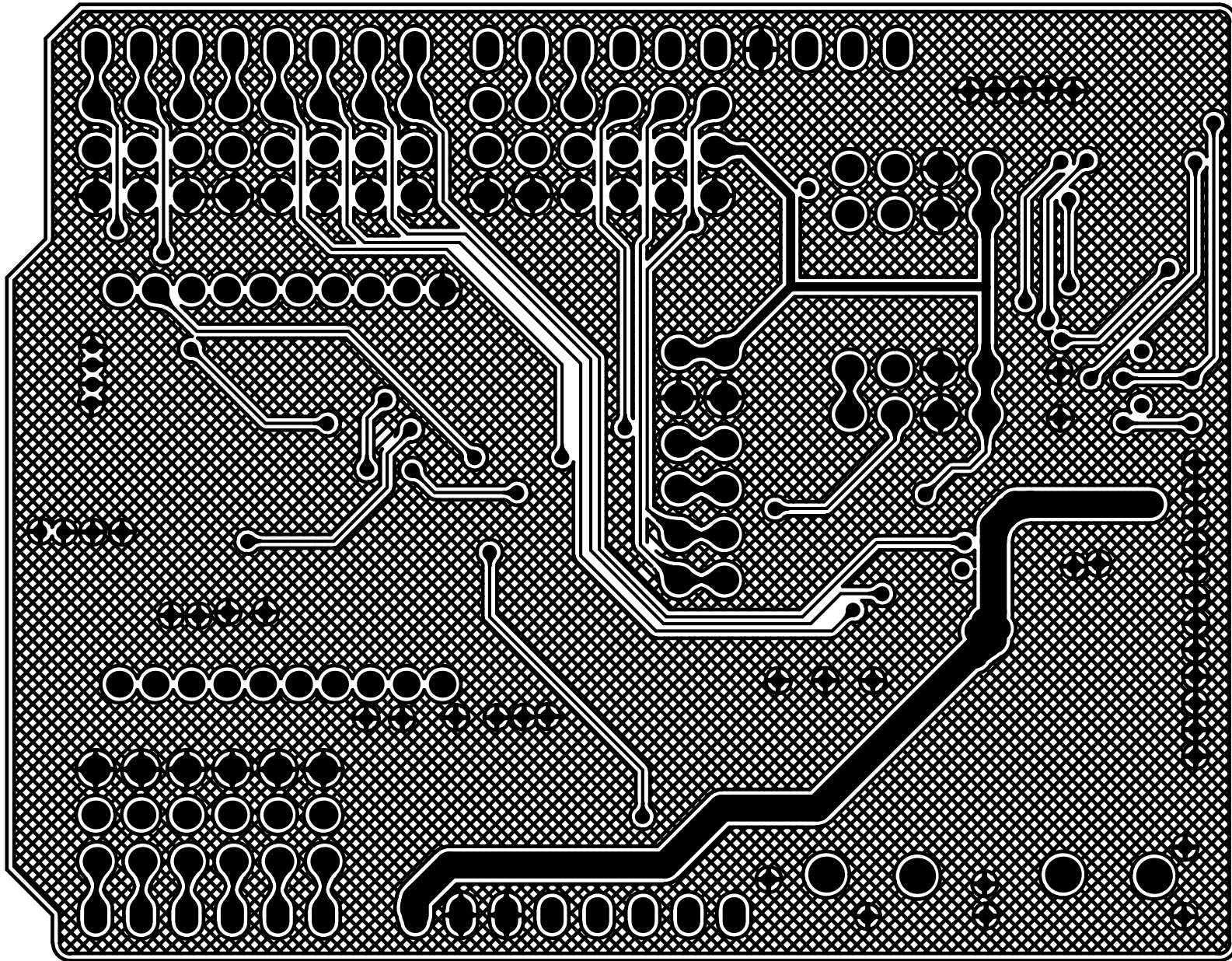

<b>PCB Information</b>	Name: DFR0502[V1.1]	Thickness: 1.6mm
Engineer: DongZi	Top SolderMask: Black	Bottom SolderMask: Black
Date: 20170928	Top Silkscreen: White	Bottom Silkscreen: White



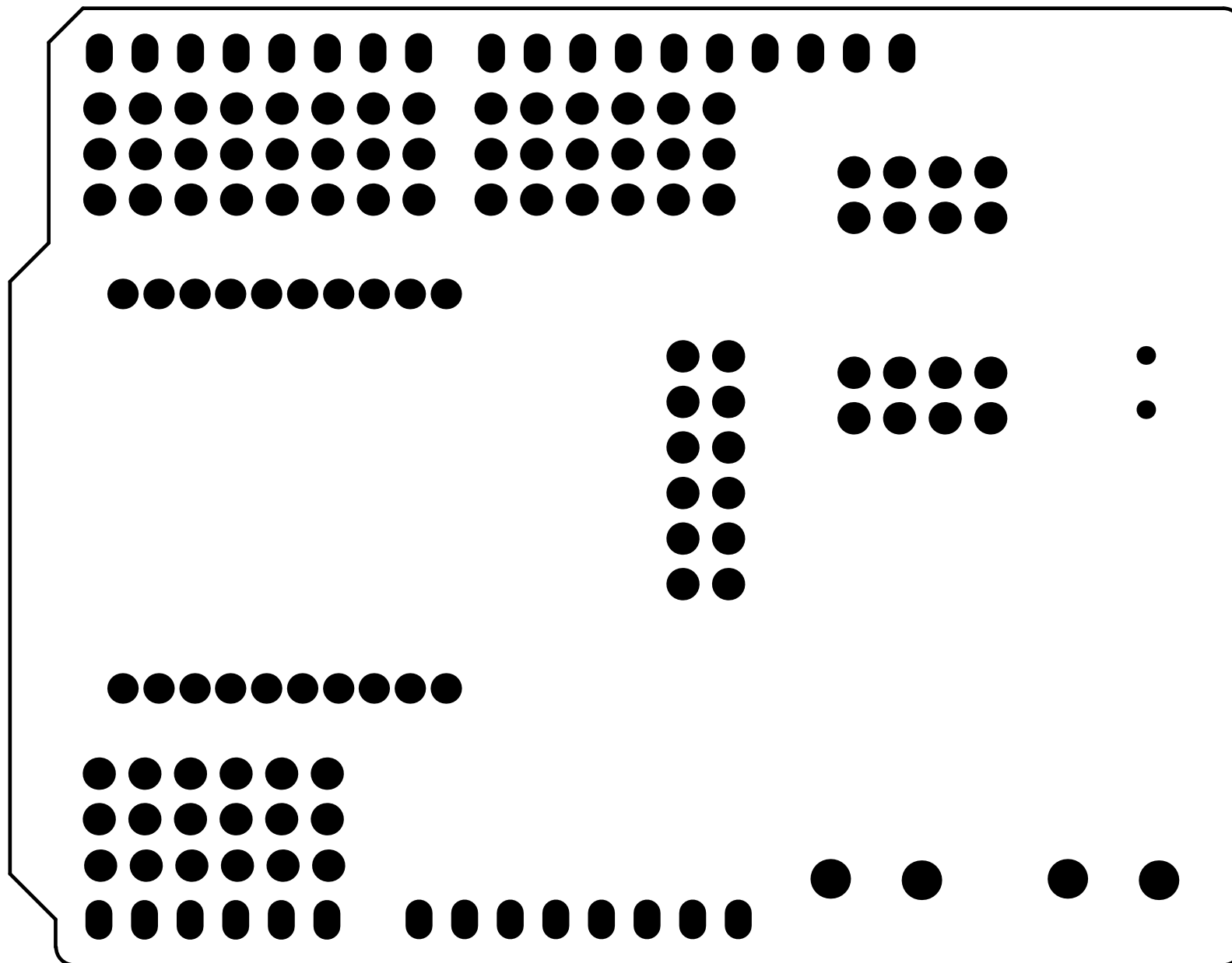

<b>PCB Information</b>	Name: DFR0502[V1.1]	Thickness: 1.6mm
Engineer: DongZi	Top SolderMask: Black	Bottom SolderMask: Black
Date: 20170928	Top Silkscreen: White	Bottom Silkscreen: White



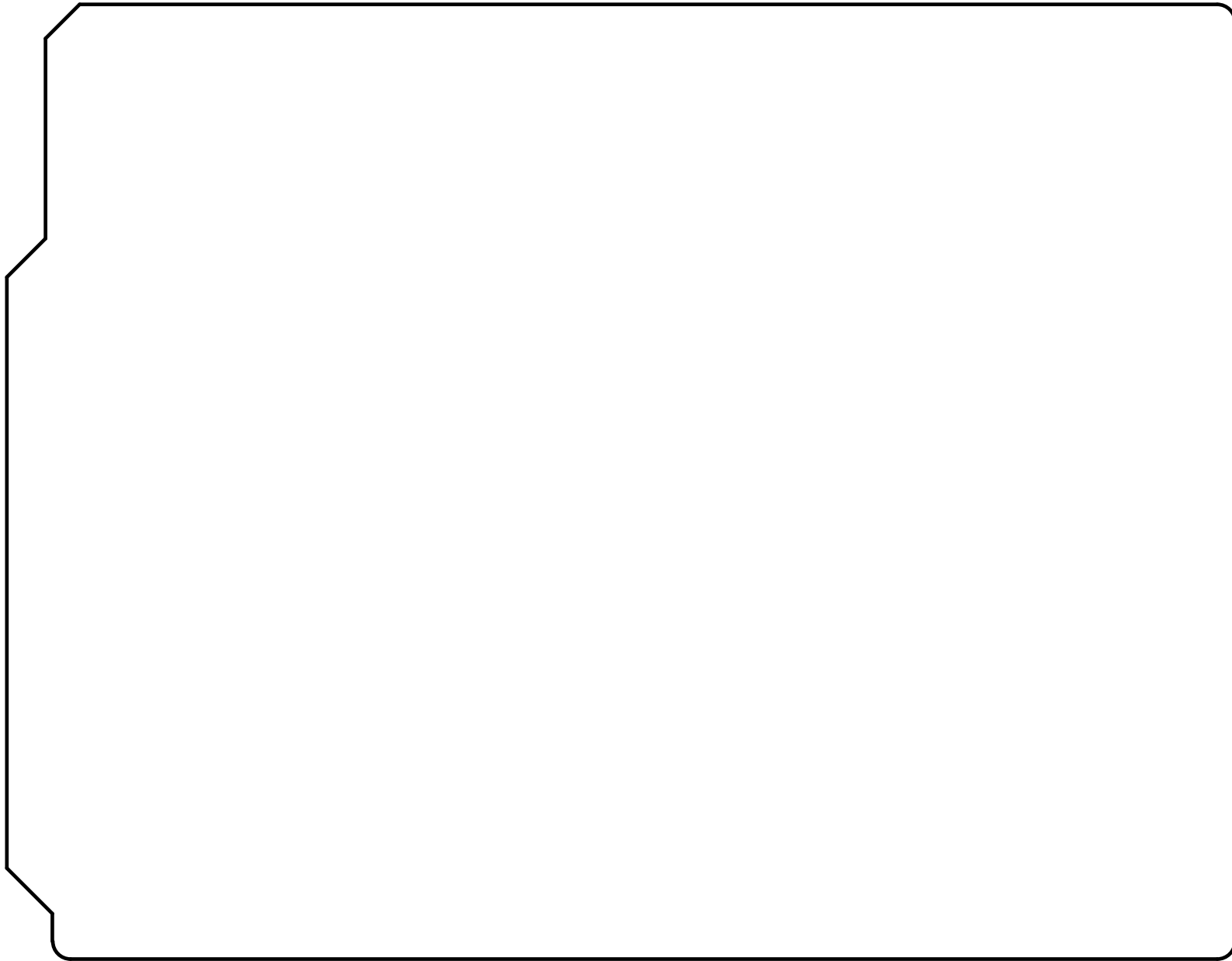

<b>PCB Information</b>	Name: DFR0502[V1.1]	Thickness: 1.6mm
Engineer: DongZi	Top SolderMask: Black	Bottom SolderMask: Black
Date: 20170928	Top Silkscreen: White	Bottom Silkscreen: White

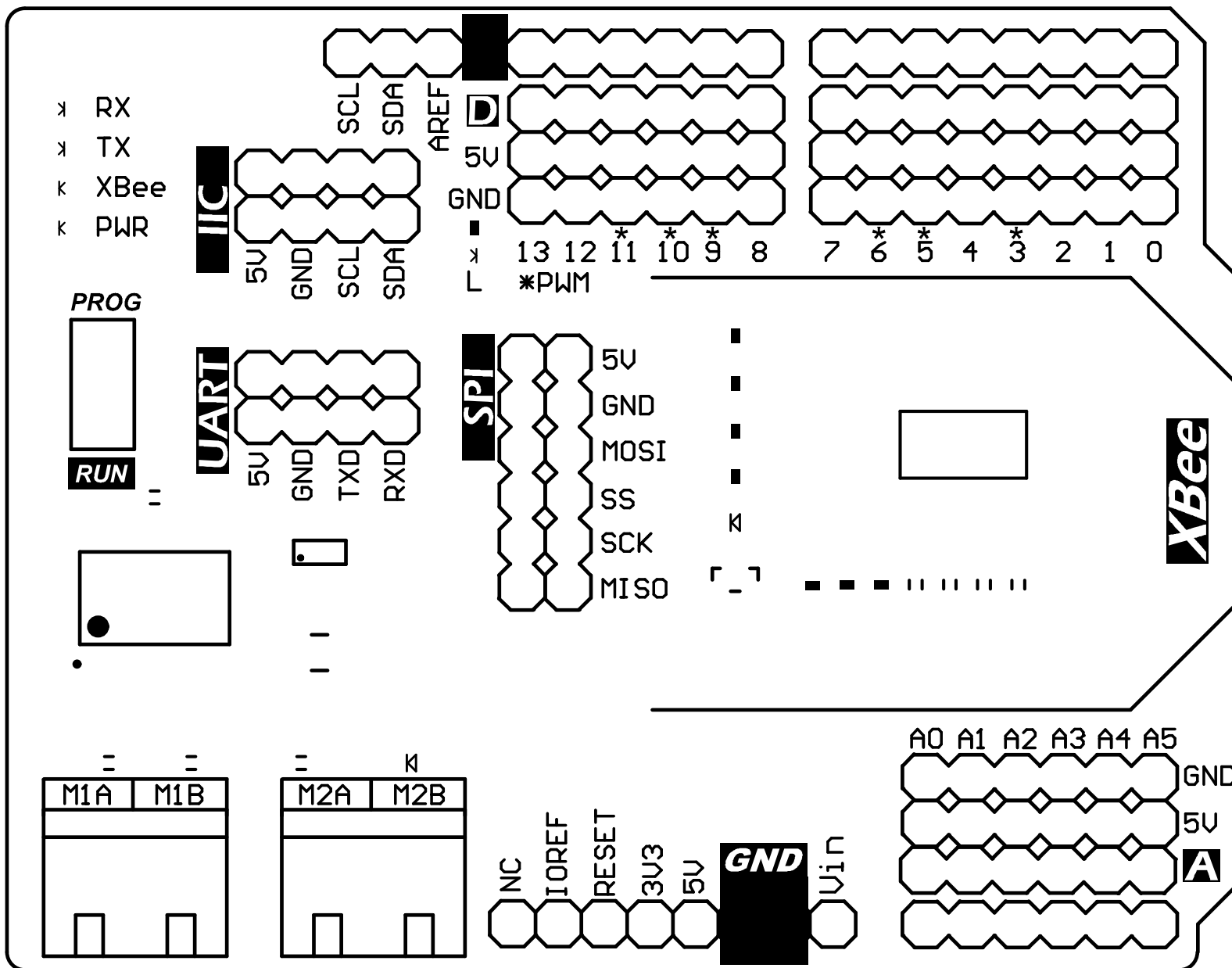

<b>PCB Information</b>	Name: DFR0502[V1.1]	Thickness: 1.6mm
Engineer: DongZi	Top SolderMask: Black	Bottom SolderMask: Black
Date: 20170928	Top Silkscreen: White	Bottom Silkscreen: White



**RUN** :Xbee Enable  
**PROG**:Uploading Enable

**Gravity:**  
**IO Expansion & Motor Driver shield V1.1**

<b>PCB Information</b>	Name: DFR0502[V1.1]	Thickness: 1.6mm
Engineer: DongZi	Top SolderMask: Black	Bottom SolderMask: Black
Date: 20170928	Top Silkscreen: White	Bottom Silkscreen: White

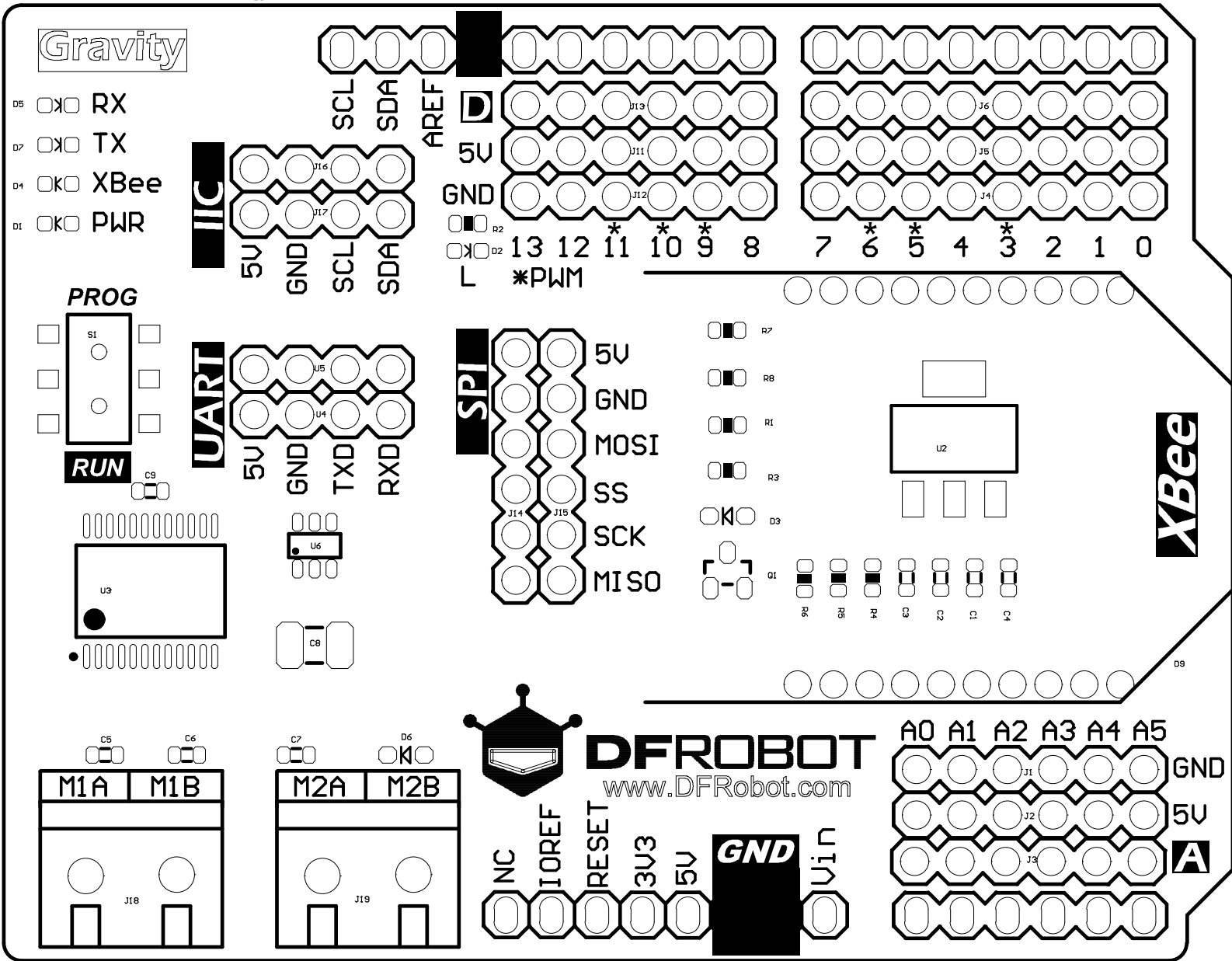

<b>PCB Information</b>	Name: DFR0502[V1.1]	Thickness: 1.6mm
Engineer: DongZi	Top SolderMask: Black	Bottom SolderMask: Black
Date: 20170928	Top Silkscreen: White	Bottom Silkscreen: White

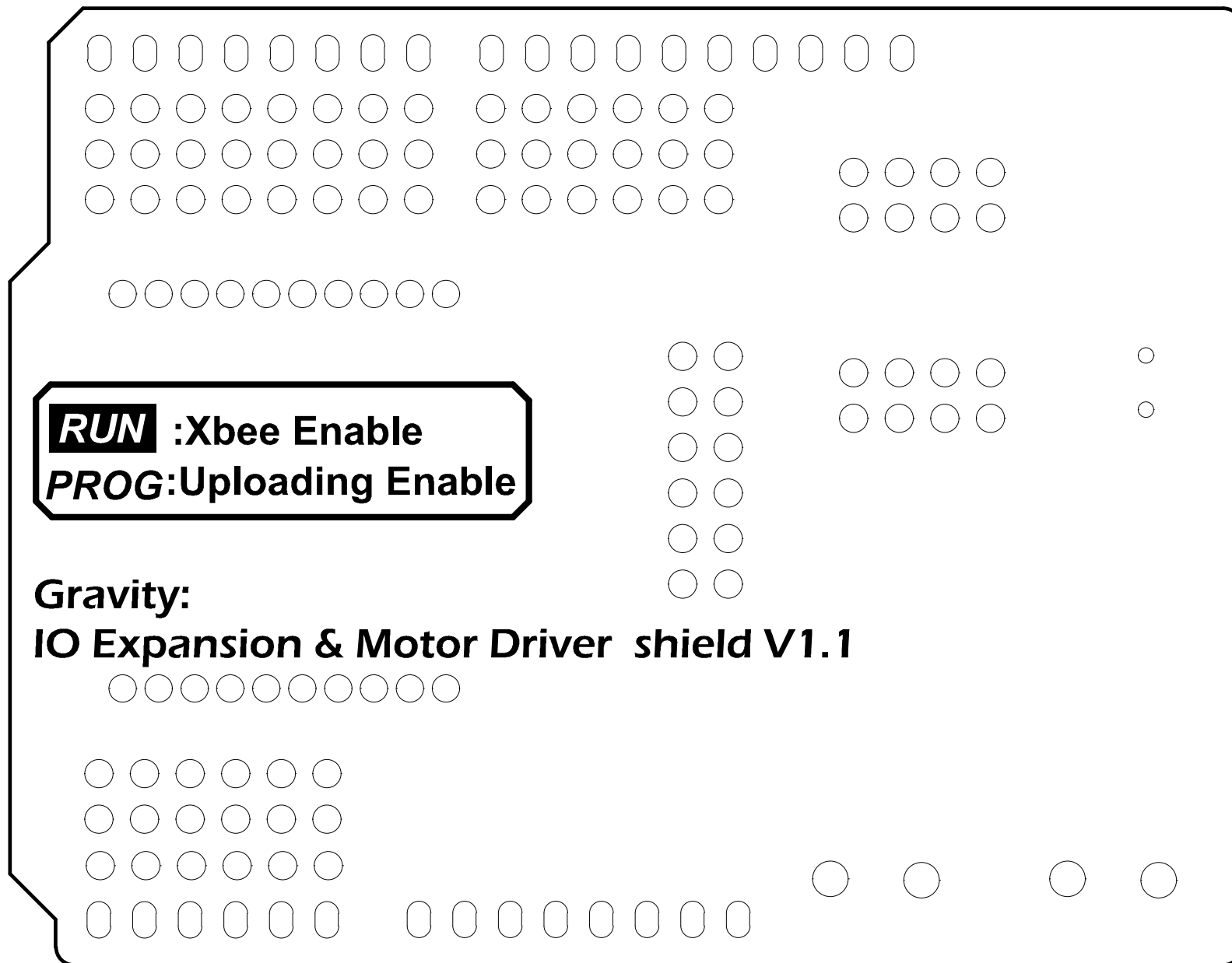

<b>PCB Information</b>	Name: DFR0502[V1.1]	Thickness: 1.6mm
Engineer: DongZi	Top SolderMask: Black	Bottom SolderMask: Black
Date: 20170928	Top Silkscreen: White	Bottom Silkscreen: White

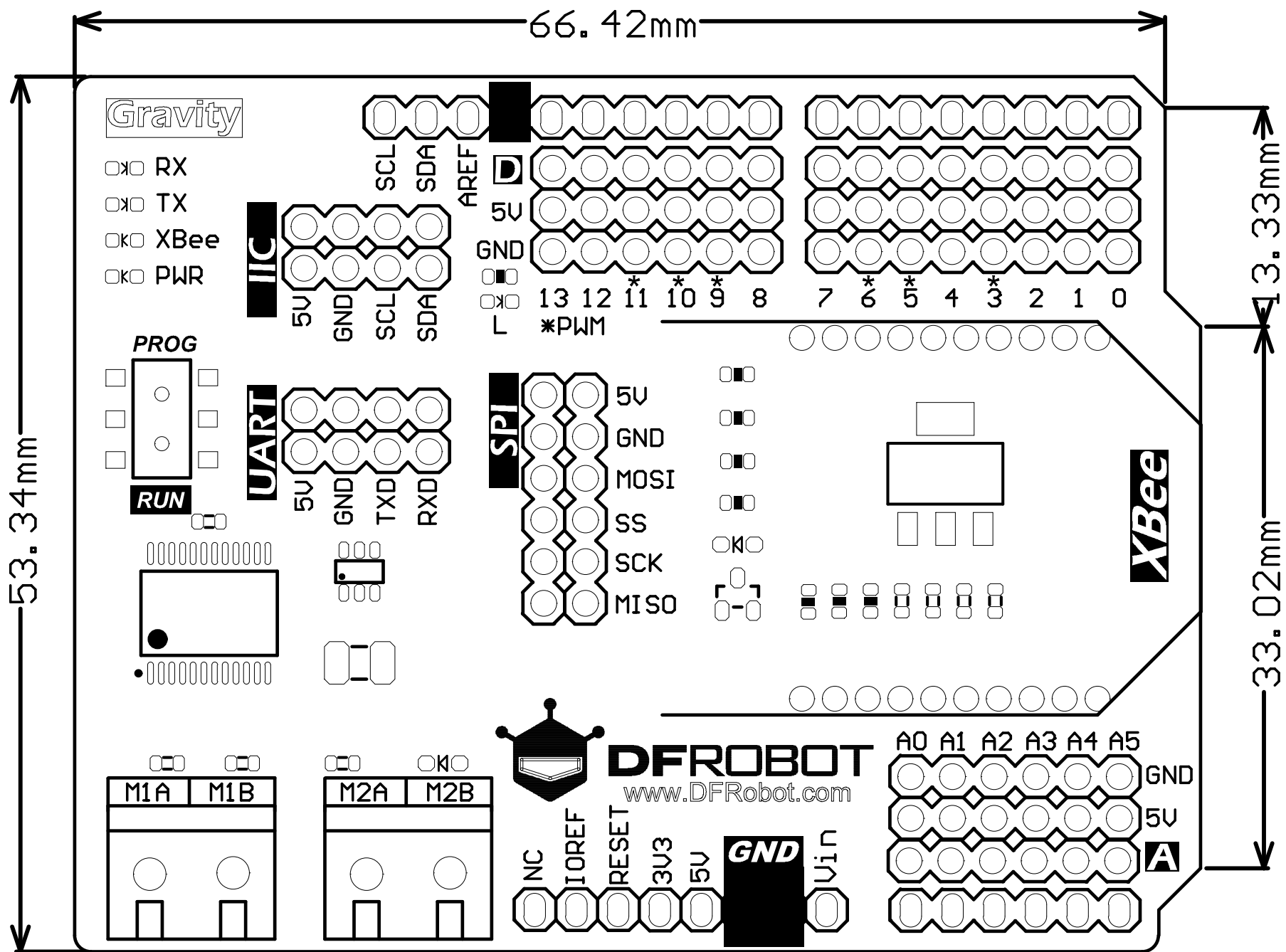

PCB Information		Name: DFR0502[V1.1]	Thickness: 1.6mm
Engineer: DongZi	Top SolderMask: Black	Bottom SolderMask: Black	
Date: 20170928	Top Silkscreen: White	Bottom Silkscreen: White	

Gravity

- RX
- TX
- XBee
- PWR

**IIC**

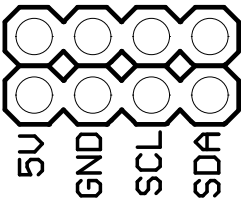

- AREF
- 5V
- GND
- L

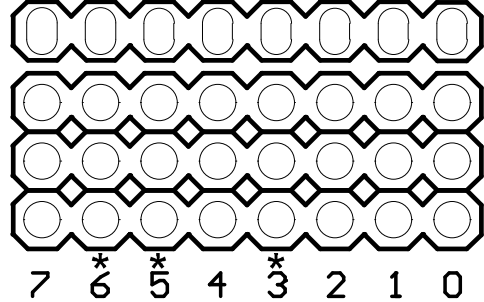
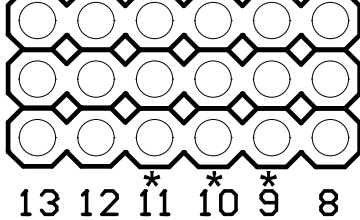

PROG

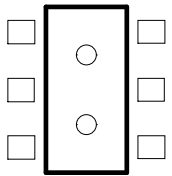

RUN

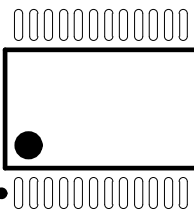

**UART**

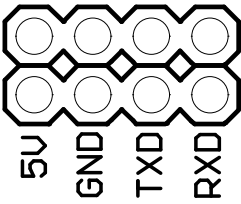

**SPI**

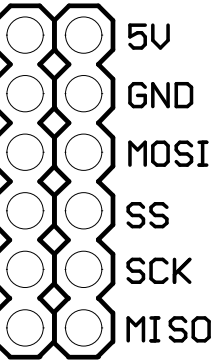

- 
- 
- 
- 
- 
- 
- 
- 

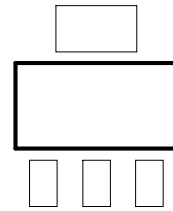

**XBee**

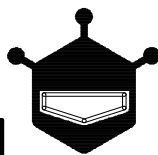
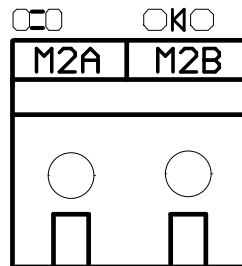
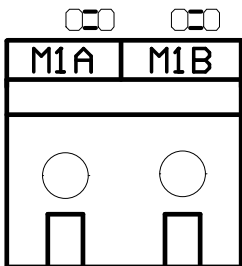

**DFROBOT**  
www.DFRobot.com

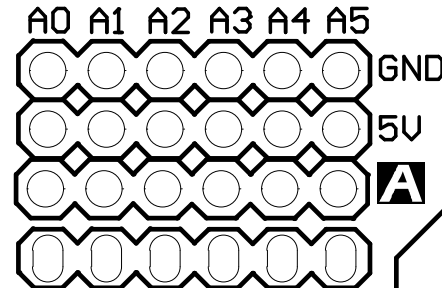

<b>PCB Information</b>	Name: DFR0502[V1.1]	Thickness: 1.6mm
Engineer: DongZi	Top SolderMask: Black	Bottom SolderMask: Black
Date: 20170928	Top Silkscreen: White	Bottom Silkscreen: White

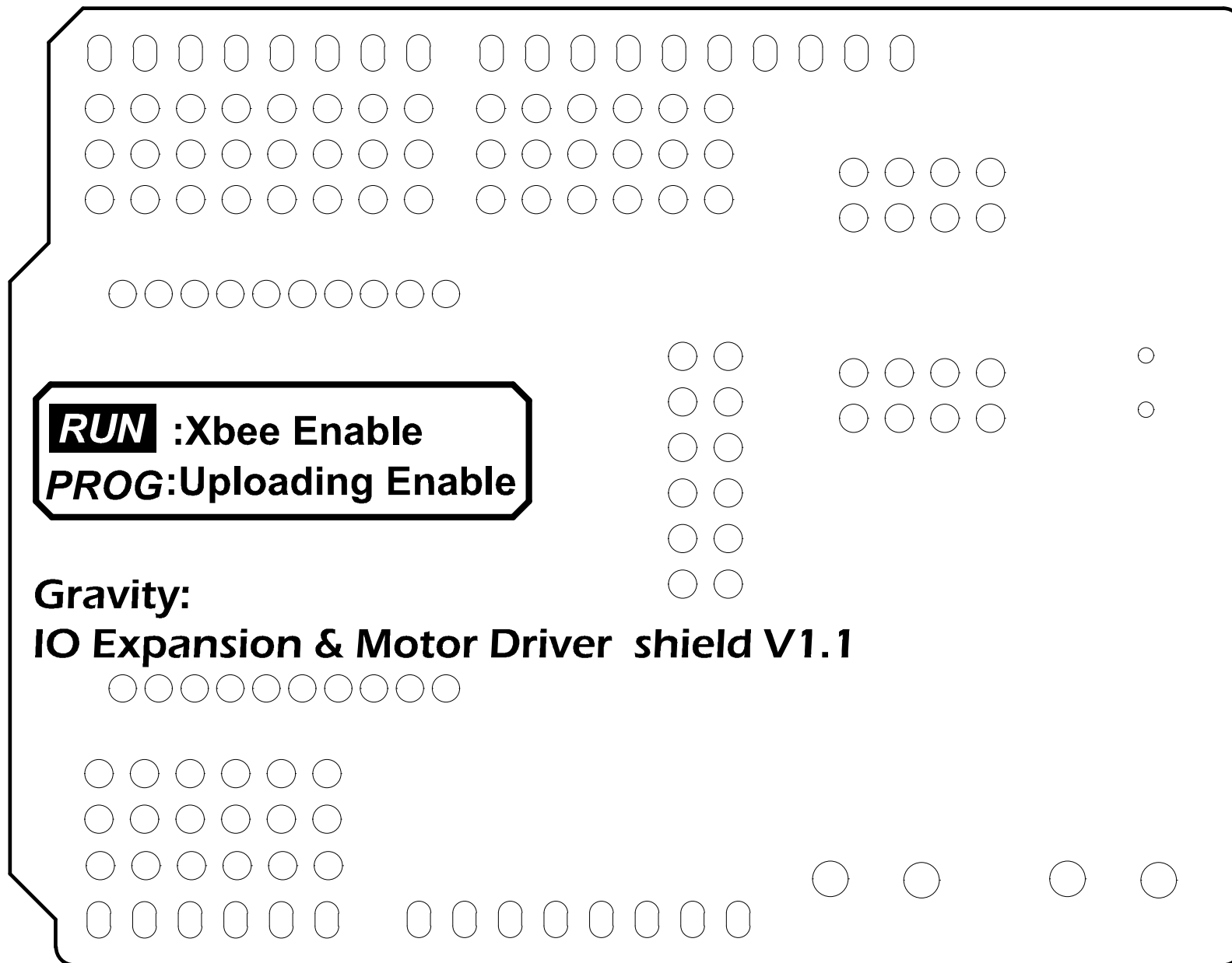

<b>PCB Information</b>	Name: DFR0502[V1.1]	Thickness: 1.6mm
Engineer: DongZi	Top SolderMask: Black	Bottom SolderMask: Black
Date: 20170928	Top Silkscreen: White	Bottom Silkscreen: White