

规格承认书

SPECIFICATION FOR APPROVAL

客户名称: _____
CUSTOMER NAME

客户料号: _____
CUSTOMER NUMBER

产品规格: 轻触开关
PROUDC NANE

我司型号: 3x4x2四脚小龟
PROUCD MODEL

我司料号: _____
PROUCD NUMBER

| | | | | |
|---|-----------------|------------|---------------|--|
| 承认单位 DEPT | 采购部 PURCHASE | 品保部 Q C | 工程 部 R & D | 承认章 APPROVAL SIGNET |
| 审 核 CHKD | | | | |
| 承 认 APPD | | | | |
| 审核结果: <input type="checkbox"/> 合格 <input type="checkbox"/> 不合格 <small>APPROVAL RESULT: <input type="checkbox"/> O K <input type="checkbox"/> N G</small> | | | | 确认后请回签一份 |
| 说明: <small>REMNrk: _____ 日期 (DATE):</small> | | | | <small>年 (YEAR) / 月 (MONTH) / 日 (DAY)</small> / / |

浙江领祥电子有限公司
 ZHEJIANG LINGXIANG ELECTRONICS CO., LTD.

地 址 : 浙江省乐清市虹桥镇幸福东路1318-2号
 电 话 : 0577-62325288 62329738
 传 真 : 0577-62329538
 电子邮件 : 2880186799@qq.com
 邮 编 : 325608

| | |
|---|-------------------|
| 发行部门 Issued Dept: 工程 部 电话 TEL: 0577-62325288 62329738 传真 FAX: 0577-62329538 | |
|  审核 GRZD | 批准 APVD |
| 吴宏伟 | 郑程磊 张旭敏 |



RoHS
REACH

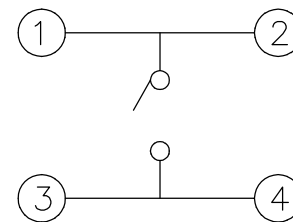
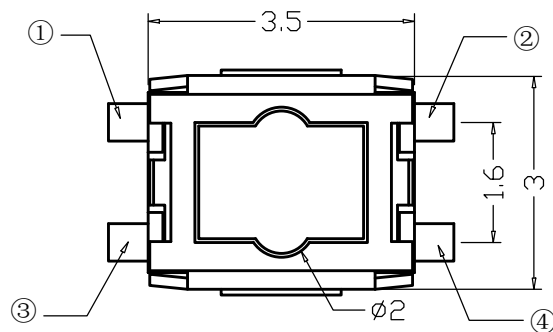
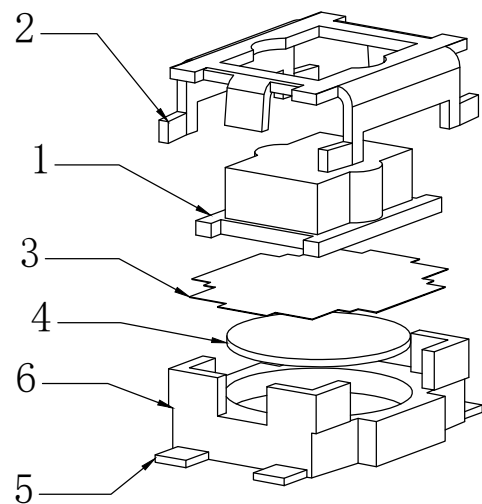

电路图

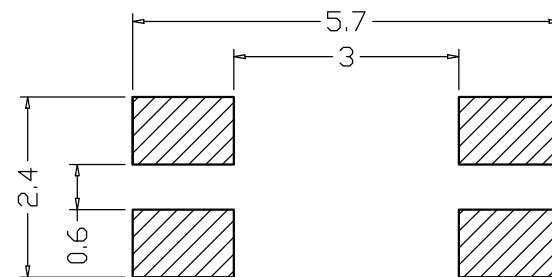
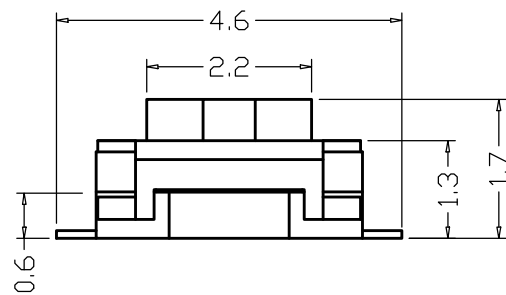

PCB线路板图

| 序号 | 产品名称 | 材料规格 | 表面处理 | 颜色 | 数量 | 性能 | | 未注尺寸公差 (mm) | | 设计 | 吴宏伟 | | 产品名称: 轻触开关 |
|----|------|------|------|----|----|------|------------|-------------|-------|-----|-----|----|------------|
| 1 | 按钮 | PPA | | | 1 | 额定规格 | DC12V/50mA | .X | ±0.20 | 审核 | 郑程磊 | | 图面 |
| 2 | 盖板 | 不锈钢 | | | 1 | 接触电阻 | ≤100mΩ | | | | | 单位 | MM |
| 3 | 防水膜 | | 黄色 | | 1 | 绝缘电阻 | ≥100MΩ | .XX | ±0.10 | 标准化 | 胡文阳 | 比例 | |
| 4 | 簧片 | 不锈钢 | | | 1 | 耐电压 | AC250V/min | | | | | 重量 | |
| 5 | 接线片 | 铜 | 镀银 | | 1 | 动作力 | 250±50gf | .XXX | ±0.01 | 批准 | 张旭敏 | 页码 | 1/1 |
| 6 | 底座 | LCP | | | 1 | | | | | | | 版次 | A/0 |

浙江领祥电子有限公司 LAXXSCOM

| | | |
|---|-------------------------|-------------|
| 浙江领祥电子有限公司 ZHEJIANG LINGXIANG ELECTRONICS CO.,LTD. | 日期 DATE | 2020-4-15 |
| | 文件编号 Document number | LX-EGHK-01B |

Specification 规格书

1. 基本说明 General specification

1.1 范围 Scope

此规范含盖单推柄和无推柄的轻触开关要求

This specification covers the requirements for single key switches which have no key top(TACT SWITCHES:MECHANICAL CONTACT).

1.2 使用温度范围 Operating Temperature Range

-20 to +70 °C 正常湿度, 标准压力 (normal humidity, normal press.)

1.3 保存温度范围 Storage Temperature Range

-25 to +85 °C 正常湿度, 标准压力 (normal humidity, normal press.)

1.4 测试条件 Test Conditions

测试和计量按下列标准条件除非特殊说明:

Tests and measurements shall be made in the following standard conditions unless otherwise specified:

标准温度 Normal temperature (temperature 5 to 35 °C)

正常湿气 Normal humidity (relative humidity 45 to 85%)

标准压力 Normal pressure (pressure 860 to 1060 mbars)

2. 动作类型 TYPE OF ACTUATION

轻触返回 Tactile feedback

3. 接触形式 CONTACT ARRANGEMENT

1 接点 1 回路 1 poles 1 throws

详细接线图在外形图中 (Details of contact arrangement are given in the assembly drawings.)

4. 额定规格 MAXIMUM RATINGS

DC 12 V 50 mA

5. 外观结构 Appearance and structure

5.1 外观: 应无明显收缩、飞边、划伤, 镀层均匀, 无脱落等现象

Appearance: It should no obvious shrinkin、upset metal、Scrape、plating path well-distributed and no coming off.

5.2 尺寸: (附外形图) Size: Making (drawing attached)

图纸见第 2 页

Specification 规格书

6. 性能 General specification

6.1 电气性能 Electrical properties

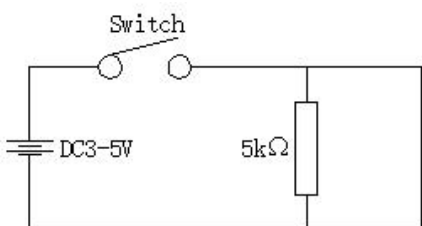
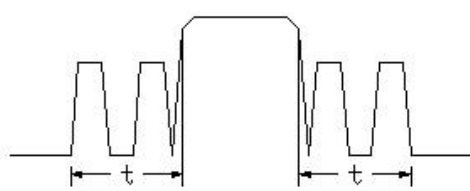
| 项目 Item | 测试条件 Test Condition | 要求 Requirements |
|---|---|---|
| 6.1.1 接触电阻 Contact Resistance | 用两倍的动作力作静负载施加于按钮的中心, 并用 <u>1</u> 千赫 (kHz) 小电流接触电阻仪测量. Applying static load twice the actuating force to the center of the stem, measurements shall be made with a <u>1</u> kHz small-current contact resistance meter. | 小于 <u>100</u> mΩ ≤ <u>100</u> mΩ |
| 6.1.2 绝缘电阻 Insulation Resistance | 在端子与端子之间, 端子与外壳之间施加 DC <u>100</u> V/一分钟 Measurements shall be made following application of DC <u>100</u> V potential between terminals and between individual terminals and frame for one minute. | 大于 <u>100</u> MΩ ≥ <u>100</u> MΩ |
| 6.1.3 耐电压 Dielectric withstanding voltage | 在端子与端子之间, 端子与外壳之间施加 AC <u>250</u> V (50HZ-60HZ) AC <u>250</u> V (50Hz or 60Hz) shall be applied between terminals and between individual terminals and frame for one minute. | 无击穿、闪烁现象 There shall be no breakdown |
| 6.1.4 抖动 Bounce | 在正常使用中(以每秒 <u>3</u> - <u>4</u> 次周期)轻轻地在手柄中心加力, 在通与断瞬间测试抖动 Lightly striking the center of the stem at a rate encountered in normal use (<u>3</u> to <u>4</u> operations per sec), Bounce shall be tested when "ON" and "OFF"   示波器 Oscilloscope t 为触点抖动时间 | <u>10</u> mS 以下 |

| | | |
|---|-------------------------|-------------|
| 浙江领祥电子有限公司 ZHEJIANG LINGXIANG ELECTRONICS CO.,LTD. | 日期 DATE | 2020-4-15 |
| | 文件编号 Document number | LX-EGHK-01B |

Specification 规格书

6.2 机械性能 Mechanical properties

| 项目 Item | | 测试条件 Test Condition | 要求 Requirements |
|------------|-------------------------|--|---|
| 6.2.1 | 动作力 Actuating Force | 开关的动作方向为垂直放置, 开关向推柄中心逐渐地增加负荷直到推柄停止时所测量的最大负荷 Place the switch such that the direction of switch operation is vertical and then gradually increase the load applied to the center of the stem, the maximum load required for the stem to come to a stop shall be measured | $\underline{250} \pm \underline{50}$ gf $\underline{180} \pm \underline{50}$ gf $\underline{100} \pm \underline{50}$ gf |
| 6.2.2 | 行程 Travel | 开关的动作方向为垂直放置开关, 并以双倍动作力的静负荷作用推柄中心, 测量推柄从开始到停止的行程距离 Place the switch such that the direction of switch operation is vertical and then apply a static load twice the actuating force to the center of the stem, the travel distance for the stem to come to a stop shall be measured | $\underline{250}$ gf: $\underline{0.25} \pm \underline{0.05}$ mm $\underline{180}$ gf: $\underline{0.20} \pm \underline{0.05}$ mm $\underline{100}$ gf: $\underline{0.20} \pm \underline{0.05}$ mm |
| 6.2.3 | 返回力 Return Force | 开关的动作方向为垂直放置开关, 在已有行程的推柄中心向上减小压力, 推柄回到自由位置时所测量到的力 The sample switch is installed such that the direction of switch operation is vertical and, upon depression of the stem in its center the whole travel distance, the force of the stem to return to its free position shall be measured | $\underline{250}$ gf: $\underline{80}$ gf min $\underline{180}$ gf: $\underline{60}$ gf min $\underline{100}$ gf: $\underline{40}$ gf min |
| 6.2.4 | 静止强度 Static Strength | 开关的动作方向为垂直放置开关, 在推柄动作方向施加 <u>1KG</u> 的静负荷, 持续 <u>60</u> 秒 Placing the switch such that the direction of switch operation is vertical, a static load of 3 kgf shall be applied in the direction of stem operation for a period of 60 seconds | 无机械的和电气的损伤迹象 There shall be no sign of damage mechanically and electrically |

| | | |
|---|-------------------------|-------------|
| 浙江领祥电子有限公司 ZHEJIANG LINGXIANG ELECTRONICS CO., LTD. | 日期 DATE | 2020-4-15 |
| | 文件编号 Document number | LX-EGHK-01B |

Specification 规格书

6.3 使用耐久性能 Service Durability

| 项目 Item | 测试条件 Test Condition | 要求 Requirements |
|--|--|---|
| 6.3.1 动作寿命 Operating Life | 按下列条件进行寿命试验: Measurements shall be made following the test set forth below: (1) 无负载条件 No load condition (2) 动作频率: <u>30</u> ~ <u>50</u> 次/分钟 Rate of operation: 30 to 50 operations per minute (3) 动作次数: 覆银铜弹片 <u>5</u> 万次 不锈钢弹片 <u>10</u> 万次 Cycles of operation: Silver coated copper <u>50,000</u> cycles Stainless steel <u>100,000</u> cycles | 接触电阻 Contact resistance: <u>300 mΩ</u> Max. 绝缘电阻 Insulation resistance: <u>100 MΩ</u> Min. 动作力 Actuating force: ± <u>30%</u> 初始动作力 + <u>30%</u> or - <u>30%</u> of initial force 项目 Item 6.2.2 |
| 6.3.2 耐潮湿 Moisture Resistance | 样品按下列条件进行耐潮湿试验, 试验后在正常温度和湿度条件下放置 <u>1</u> 小时后测定 Following the test set forth below the sample shall be left in normal temperature and humidity conditions for one hour before measurements are made. (1) 温 度 Temperature: <u>40 ± 2</u> °C (2) 相对湿度 Relative humidity: <u>90 to 95%</u> (3) 时 间 Time: <u>96</u> 小时 hours 擦除水珠 Water drops shall be removed. | 接触电阻 Contact resistance: <u>300 mΩ</u> Max. 绝缘电阻 Insulation resistance: <u>100 MΩ</u> Min 项目 Item 6.1.3、6.1.4 项目 Item 6.2.1~6.2.3 |
| 6.3.3 耐低温 Low Temperature Resistance | 样品按下列条件进行耐低温试验, 试验后在正常温度和湿度条件下放置 <u>1</u> 小时后测定 Following the test set forth below the sample shall be left in normal temperature and humidity conditions for one hour before measurements are made (1) 温 度 Temperature: <u>-20 ± 2</u> °C (2) 时 间 Time: <u>96</u> 小时 hours 擦除水珠 Water drops shall be removed. | 接触电阻 Contact resistance: <u>300 mΩ</u> Max. 绝缘电阻 Insulation resistance: <u>100 MΩ</u> Min 项目 Item 6.1.3、6.1.4 项目 Item 6.2.1~6.2.3 |

Specification 规格书

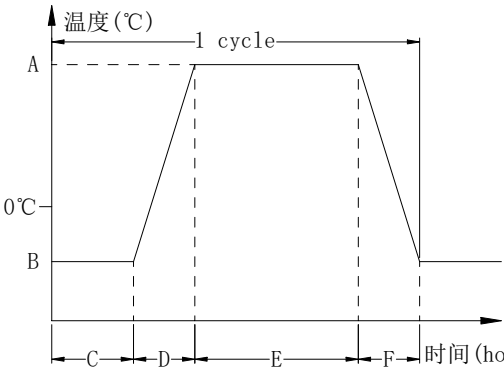
| 项目 Item | 测试条件 Test Condition | 要求 Requirements |
|---|--|--|
| 6.3.4 耐热 Heat Resistance | <p>样品按下列条件进行耐热试验, 试验后在正常温度和湿度条件下放置 <u>1</u> 小时后测定</p> <p>Following the test set forth below the sample shall be left in normal temperature and humidity conditions for one hour before measurements are made</p> <p>(1) 温度 Temperature: <u>70 ± 2</u> °C (2) 时间 Time: <u>96</u> 小时 hours</p> | <p>接触电阻 Contact resistance: <u>300 mΩ</u> Max.</p> <p>绝缘电阻 Insulation resistance: <u>100 MΩ</u> Min</p> <p>项目 Item 6.1.3、6.1.4 项目 Item 6.2.1~6.2.3</p> |
| 6.3.5 温度循环 Change of Temperature | <p>样品按下列条件进行高低温循环试验, 试验后在正常温度和湿度条件下放置 <u>1</u> 小时后测定</p> <p>Following ten cycles of high temperature test. The Sample shall be Placed in Normal temperature and humidity Conditions for one hour before measurements are made. During this test, water drops shall be removed</p>  <p>温度(°C)</p> <p>1 cycle</p> <p>A</p> <p>0°C</p> <p>B</p> <p>C D E F 时间(hour)</p> <p>A: <u>+ 85 ± 2</u> °C B: <u>- 25 ± 2</u> °C C: <u>2</u> 小时 D: <u>1</u> 小时 E: <u>2</u> 小时 F: <u>1</u> 小时</p> <p>周 期: <u>5</u> 次 Cycling: Five cycles</p> | <p>接触电阻 Contact resistance: <u>300 mΩ</u> Max.</p> <p>绝缘电阻 Insulation resistance: <u>100 MΩ</u> Min</p> <p>项目 Item 6.1.3、6.1.4 项目 Item 6.2.1~6.2.3</p> |
| 6.3.6 盐雾测试 Salt Spray Test | <p>样品按下列条件进行盐雾试验</p> <p>The salt spray test shall be conducted at the following conditions:</p> <p>(1) 浓度 Density: 溶液 (<u>5 ± 1</u>) %NaCl (质量百分比)</p> <p>(2) 温度 Temperature: <u>35 ± 2</u> °C</p> <p>(3) 时间 Time: 铁盖 <u>6</u> 小时 hours 铜盖 <u>24</u> 小时 hours</p> | <p>金属件无发黄、生锈 No yellowing and rusting of metal parts</p> |

Specification 规格书

| 项目 Item | 测试条件 Test Condition | 要求 Requirements |
|--|---|--|
| 6.3.7 耐振动 Vibration Resistance | <p>按下列条件进行抗振动试验 Measurements shall be made following the test set forth below:</p> <p>(1) 频率范围 Range of oscillation: <u>10 to 55</u> Hz (2) 振幅 Amplitude: 峰-峰 <u>1.5 mm</u> (pk-to-pk: <u>1.5 mm</u>) (3) 扫描周期 Cycle of sweep: <u>10 - 55 - 10</u> Hz 约一分钟内 (in one minute, approx.) (4) 扫描方式 Mode of sweep: 对数扫描式恒定扫描 (Logarithmically sweep or uniform sweep.) (5) 振动方向 Direction of oscillation: <u>3</u> 个相互垂直方向, 包括推柄行程方向 (Three mutually perpendicular directions, including the direction of stem travel.) (6) 每方向 <u>2</u> 小时, 共 <u>6</u> 小时 (<u>2</u> hours each, for a total of <u>6</u> hours.)</p> | <p>项目 Item 6.1 项目 Item 6.2.1、6.2.2</p> |
| 6.3.8 抗冲击 Impact Shock Resistance | <p>按下列条件进行冲击试验 Measurements shall be made following the test set forth below:</p> <p>(1) 加速度 Acceleration: <u>80</u> g (2) 试验次数 Cycles of test: 每个方向 <u>3</u> 次, <u>6</u> 个方向共 <u>18</u> 次 (<u>3</u> cycles each in <u>6</u> directions, for a total of <u>18</u> cycles)</p> <div data-bbox="526 1478 1021 1836" data-label="Image"> <p>The diagram shows a 3D perspective view of a rectangular prism. Six arrows point towards the center of each of the six faces (top, bottom, front, back, left, and right), indicating that impact tests are performed from all six directions.</p> </div> | <p>项目 Item 6.1 项目 Item 6.2.1、6.2.2</p> |

Specification 规格书

7. 焊接条件 Welding conditions

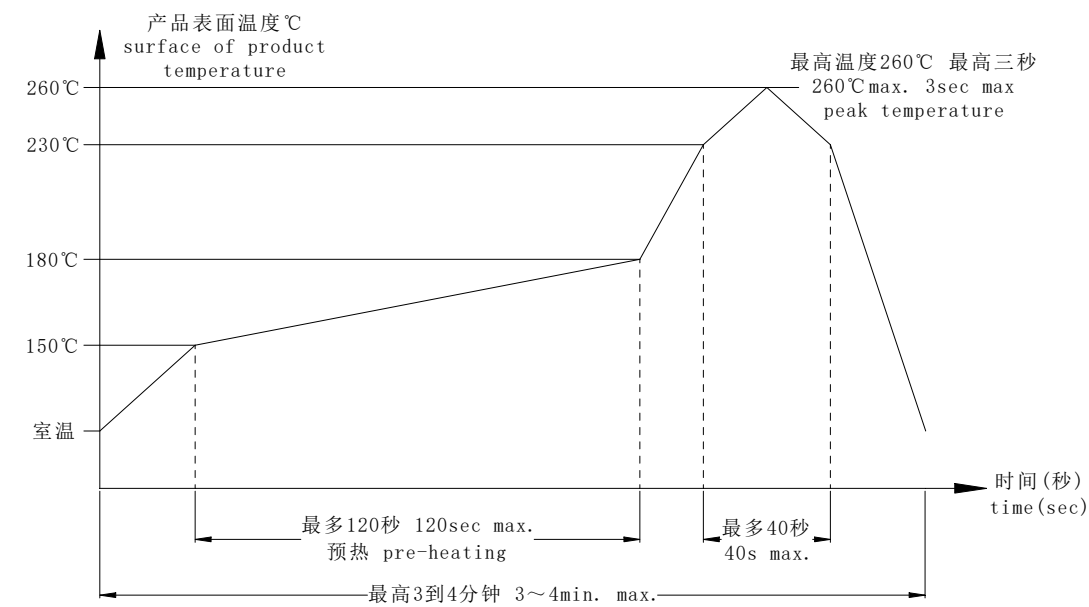
| 项目 Item | 推荐条件 Recommended conditions |
|---|---|
| 7.1 手工焊接 Hand soldering | <p>请按以下条件进行焊接： (1) 焊锡温度：$\leq 380\text{ }^{\circ}\text{C}$ (2) 连续焊接时间：$\leq 3\text{ S}$ (3) 电烙铁的功率：$\leq 60\text{ W}$</p> <p>Please practice according to bellow conditions: (1) Soldering temperature : $\leq 380\text{ }^{\circ}\text{C}$ (2) Continuous soldering time: $\leq 3\text{ S}$ (3) Capacity of soldering iron: $\leq 60\text{ W}$</p> |
| 7.2 自动焊接 Automatic flow soldering | <p>本产品，请按以下条件进行焊接： This product ,type solder according to the following conditions:</p>  <p>注意：以上提及的条件是零部件上 PWB 表面的温度, 由于 PWB 的材料、尺寸、厚度等不同, PWB 从开关表面获得的温度也会有很大不同, 因此, 千万小心不要让开关表面温度超过 $260\text{ }^{\circ}\text{C}$. Caution: the condition mentioned above is a temperature on the PWB surface on which parts are mounted. There are cases where PWB temperature greatly differs from switch's surface temperature depending on PWB material, size, thickness, etc. The switch's surface temperature shall not allowed to exceed $260\text{ }^{\circ}\text{C}$</p> |

| | | |
|--|-------------------------|-------------|
| 浙江领祥电子有限公司 ZHEJIANG LINGXIANG ELECTRONICS CO., LTD. | 日期 DATE | 2020-4-15 |
| | 文件编号 Document number | LX-EGHK-01B |

Specification 规格书

8. 其他注意事项 Other precautions

(1) 进行焊接过程中, 不可以用溶剂或类似品清洗开关

Following the soldering process, do not try to clean the switch with a solvent or the like.

(2) 防止助焊剂从开关的顶端渗入

Safeguard the switch assembly against flux penetration from its topside.

(3) 交货后保证开关处于封密状态并库存时间 90 天以下。

Please have the products keep in close status and the storage time is 90 days guaranty after delivering the goods at most.